

Pro Gear's Dana Transfer Case Service Manual to assist in identifying your Dana/Spicer Transfer Case.

If you need any assistance identifying the correct Dana transfer case unit for your truck or equipment, contact your Dana replacement specialists at Pro Gear and Transmission.

Pro Gear stocks every part for your Dana transfer case and has same day shipping and 1000's of products in stock and ready to ship internationally for your next project.

For parts or service contact the Dana - Spicer specialists at Pro Gear & Transmission, Inc.

1 (877) 776-4600  
(407) 872-1901  
parts@eprogear.com

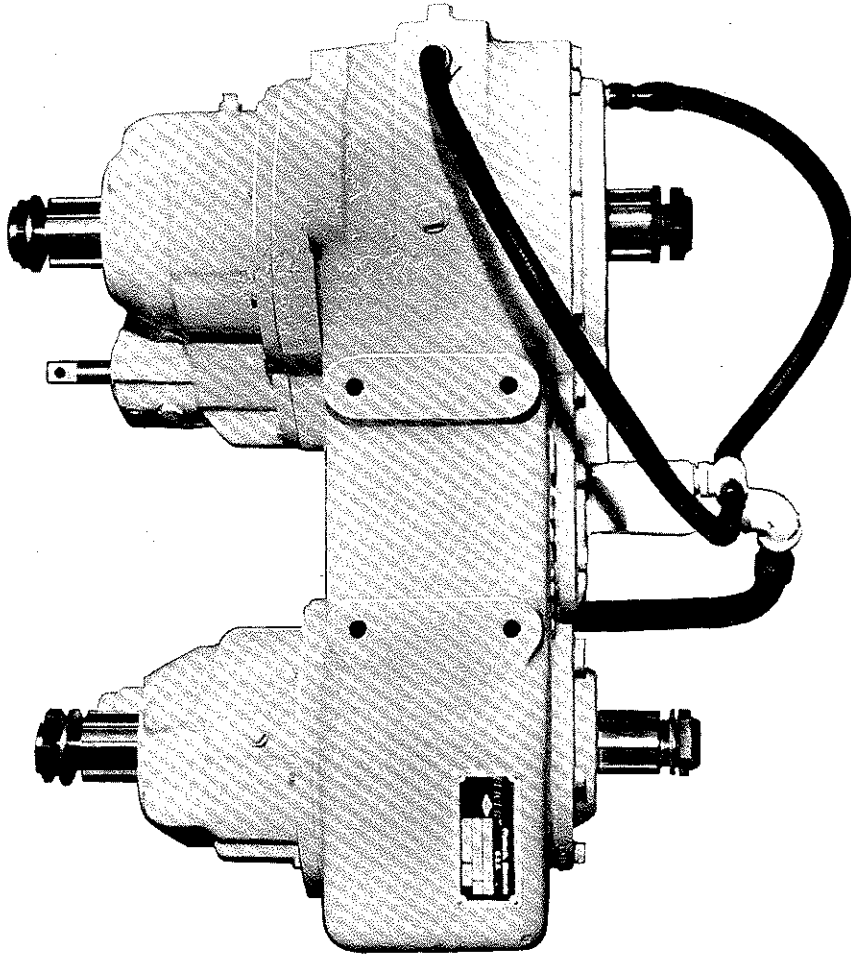

## TRANSFER CASE

On sand, ice, snow, mud or severe grades, there is nothing like all-wheel drive to take you through really tough terrain. With the Spicer transfer case, you can take your big trucks where the work is, simply by pulling a lever and engaging the front wheel drive. You don't have to bring the work out to the trucks...take the trucks to the work.

The Spicer transfer case should be standard equipment on most "all-purpose" vehicles such as lumber fleets, snow plow vehicles and oil field hauling because it delivers maximum power on all transmission speeds.

The Spicer transfer case can be coupled directly to a Spicer auxiliary transmission. It provides full torque capacity to both front and rear axles.

Conventionally geared in a 1 to 1 ratio, with no reduction, the unit features spur gears throughout. An optional front wheel disconnect is available to allow disengagement when all-wheel drive is not required. The disconnect is available in manual or air both supplied with an electrical indicator switch.

# **SPICER®**



Ball bearing mounted gears and shafts prevent premature malfunctions.

Available with customer specified end yokes or companion flanges.

One piece construction provides rigidity necessary to withstand off highway usage.

Available with forced lubrication provisions.

Versatile design offers many configurations for customer requirements.

Constant mesh gears assure long life.

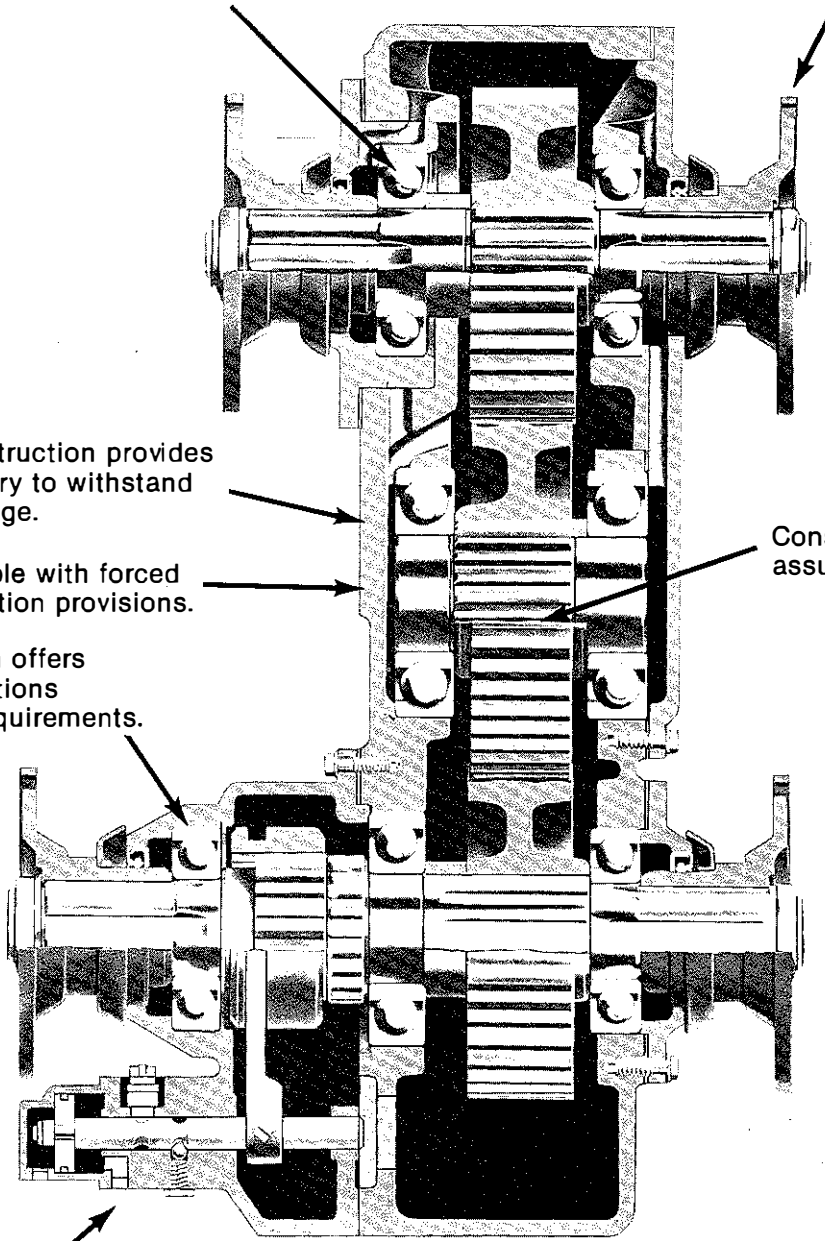

Customer can specify two different shift operations - air or manual

Available with integral Spicer Auxiliary transmissions.

Drop Gear

Ratio - 1:1

Weight - 450 Lbs. Dry

Continuous Duty Torque Rating — 3725 lb-ft.

Manual Transmission Low Gear Net Torque Rating (Based on 85% Efficiency) — 10,000 lb-ft.

Automatic Transmission Stall Torque Rating = 11,000 lb-ft. (Stall Torque Value to be taken from Engine-Transmission Performance Curve).

Maximum Operating Speed = 5000 RPM

The maximum torque at the transfer case can be limited by either the engine capacity or the vehicle wheel skid. All applications must be approved by our Engineering Department.

---

## MODEL NUMBER CONSTRUCTION TABLE

---

The disconnect requires air to both engage and disengage the output. A detent is added on the shifter spool to maintain position if air supply is lost. There is also a manual shift option available for this design with an indicator light switch being standard on both. The line drawing (on page 6) illustrates both options in detail.

The control inside the cab will need to be a 4-way valve so that air can be supplied to either side of the piston in the disconnect. The indicator light switch needs to be wired from the battery (or another source) to one terminal and also to a light in the cab. The light should be in the "ON" position when the disconnect is engaged. Air pressure to shift is 80 PSI minimum while the manual requires a pull of 125 lbs. at the spool end.

The air shift will be designated with an "E" while the manual will be "M" in the model number. With this new design, even the rear axle output disconnect can now be air shifted without adapting an air cylinder to the manual shift. The shifter option for the rear axle output will come after the lower rear output flange position in the model number.

The only modifications needed for the disconnect will be the cab air control for shifting the air disconnect, or the linkage for shifting the manual disconnect.

Regardless of the model number, units with disconnects on the side opposite the lube pump or lube pump mounting surface, use the following conversion kits:

420504X	Air shift with indicator switch
420505X	Manual with indicator switch

Units with disconnects on the same side as the lube pumps use the conversion kits listed below:

420506X	Air shift with indicator switch
420507X	Manual with indicator switch



# 738 TRANSFER CASE MODEL NUMBER CONSTRUCTION TABLE

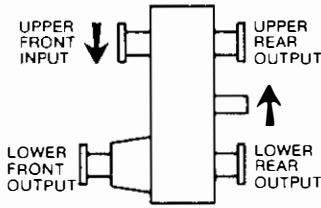

## Model 738

	Model Description	Speedometer Gear Sets	
		Drive Gear	Driven Gear
A	Remote Mount (No speedo avail.)	—	—
B	Direct Mount W/speedo	70-452-5 (3T)	70-453-2 (12T)
C	Direct Mount W/speedo	70-452-6 (4T)	70-453-4 (12T)
D	Direct Mount W/speedo	70-452-8 (3T)	70-453-1 (14T)
E	Direct Mount without speedo	▲	—

▲ - Use 70-452-8 as spacer

No Symbol  
Less Trunion  
T = Trunion available with 738B, C, D, & E only  
Basic Model

Forced Lube = F, CW  
Forced Lube = G, CCW  
Splash Lube = S

Upper Front Input  
\*See flange listing opposite page 0 thru 9, N, P, X, Y

Lower Front Output  
Shifter options  
M = Manual shift with indicator switch  
E = Air shift with indicator switch  
L = Less shifter

Lower Front Output  
\*See flange listing opposite page 0 thru 9, N, P, X, Y

Lower Rear Output  
\*See flange listing opposite page 0 thru 9, N, P, X, Y

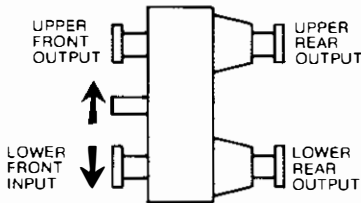

## Model 784

Basic Model

Upper Rear Output  
\*See flange listing opposite page 0 thru 9, N, P, X, Y

Upper Rear Output  
Shifter options  
M = Manual shift with indicator switch  
E = Air shift with indicator switch

Lower Rear Output  
\*See flange listing opposite page 0 thru 9, N, P, X, Y

Forced Lube = F, CW  
Forced Lube = G, CCW

Upper Front Output  
\*See flange listing opposite page 0 thru 9, N, P, X, Y

Lower Front Input  
\*See flange listing opposite page 0 thru 9, N, P, X, Y

Lower Rear Output  
Shifter options  
M = Manual shift with indicator switch  
E = Air shift with indicator switch

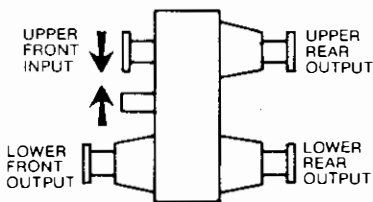

## Model 785

Basic Model

Upper Rear Output  
\*See flange listing opposite page 0 thru 9, P, X, Y

Upper Rear Output  
Shifter options  
M = Manual shift with indicator switch  
E = Air shift with indicator switch

Lower Rear Output  
\*See flange listing opposite page 0 thru 9, P, X, Y

Lower Rear Output  
Shifter options  
M = Manual shift with switch  
E = Air shift with switch

Forced Lube = F, CW  
Forced Lube = G, CCW

Upper Front Input  
\*See flange listing opposite page 0 thru 9, N, P, X, Y

Lower Front Output  
Shifter options  
M = Manual shift with indicator switch  
E = Air shift with indicator switch

Lower Front Output  
\*See flange listing opposite page 0 thru 9, P, X, Y

# 738 TRANSFER CASE MODEL NUMBER CONSTRUCTION TABLE

# Spicer®

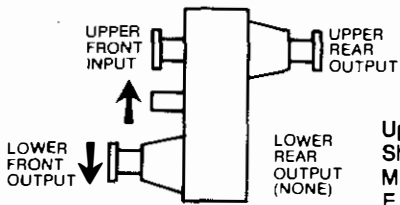

**Model  
791**

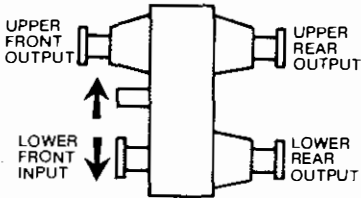
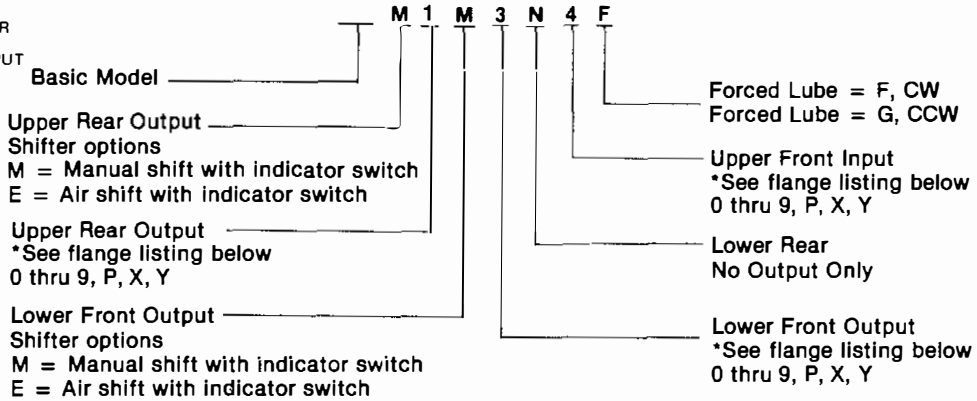

**Model  
792**

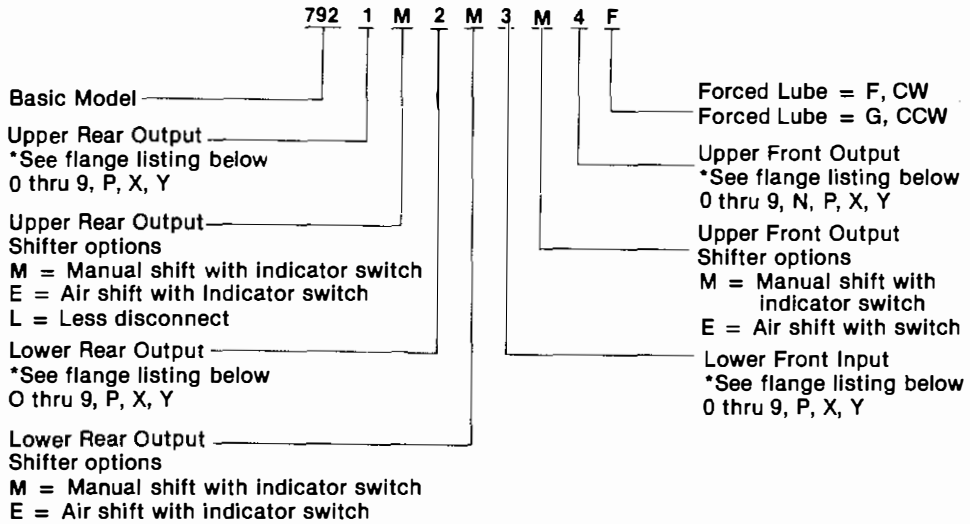

↑ Direction of rotation must be determined for proper pump selection.  
↓

Note: F = H378889-1 Clockwise Rotation Input Pump  
G = H378853-1 Counter Clockwise Rotation Input Pump

## \* FLANGE and END YOKE LISTING

- O = 5-1-2541, 1610 Series Flange
- 1 = 5-1-4641X, 1610 Series Flange with Slinger
- 2 = 6-1-1731, 1710 Series Flange
- 3 = 6-1-4091X, 1710 Series Flange with Slinger
- 4 = 6.5-1-481, 1810 Series Flange
- 5 = 6.5-1-1471X, 1810 Series Flange with Slinger
- 6 = 6-4-3031, 1710 End Yoke
- 7 = 6-4-3461X, 1710 End Yoke with Slinger
- 8 = 6.5-4-1971, 1810 End Yoke
- 9 = 6.5-4-2831X, 1810 End Yoke with Slinger

- N = No output (Blanked off)
- P = No flange, output (Paper sleeve)
- X = 5-4-4751X, 1610 End Yoke with Slinger
- Y = 6-1-1481, 1710 Series Flange

# DISCONNECTS FOR SPICER HEAVY-DUTY TRANSFER CASES

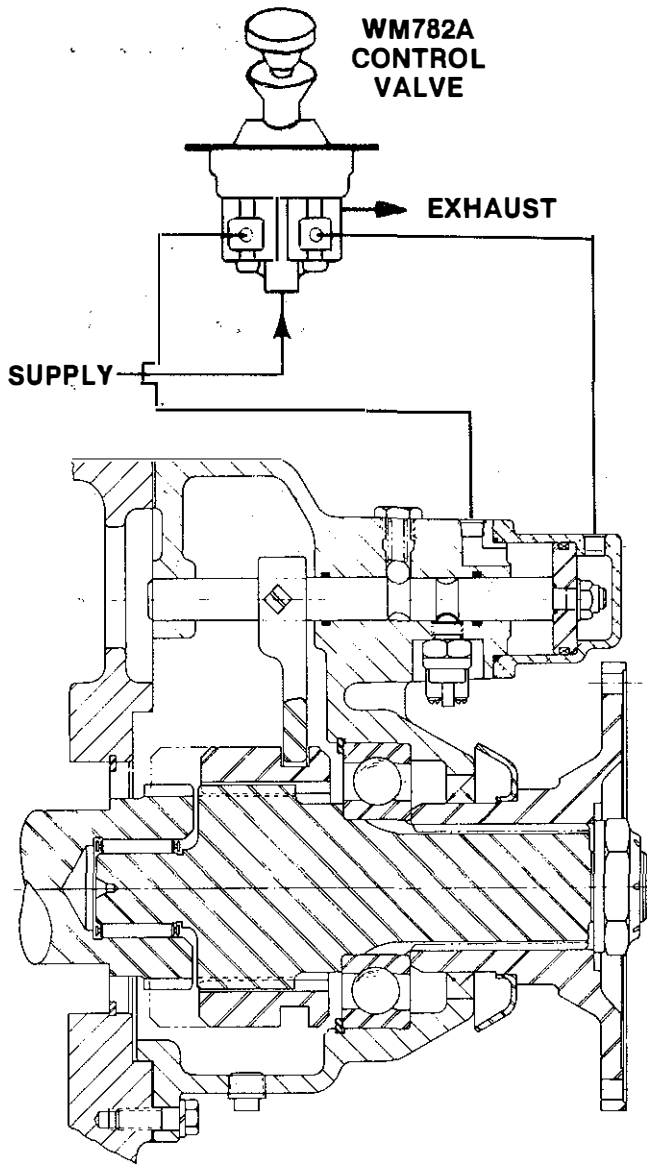

**AIR SHIFT W/INDICATOR SWITCH**

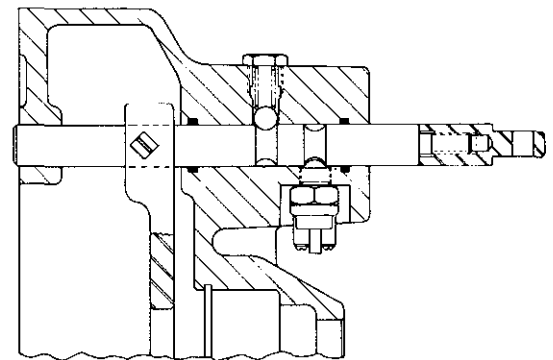
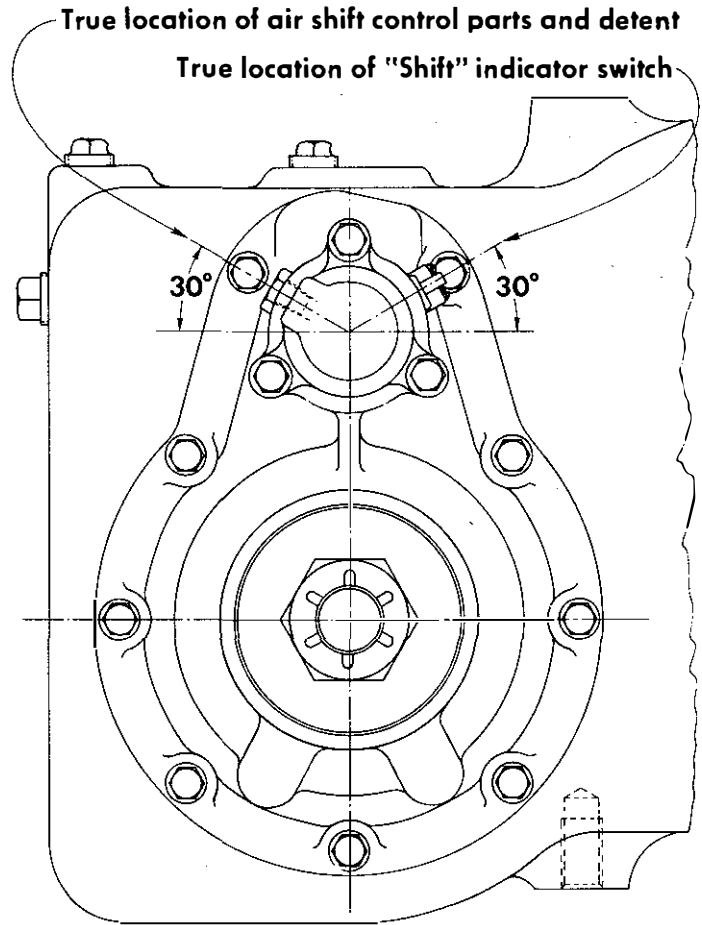

**MANUAL SHIFT W/INDICATOR SWITCH**

# LUBRICATION

To insure proper lubrication and operating temperatures in these units, it is most important that the specified lubricants be used and that correct oil levels be maintained.

## RECOMMENDED LUBRICANTS

The lubricants listed below are recommended in order of preference for use in all Spicer mechanical transfer cases.

**DO NOT USE EXTREME PRESSURE ADDITIVES** such as found in multipurpose or rear axle type lubricants. These additives are not required in Spicer transfer cases. Multipurpose oils, as a group, have relatively poor oxidation stability, a high rate of sludge formation, and a greater tendency to react on or corrode the steel and bronze parts.

## OIL CHANGES

Over-The-Road Service: Initial flush and oil change after 1000 miles of service, but not to exceed 4000 miles of service.

Scheduled flush and oil change every 20,000 miles of service after initial oil change.

Check oil level every 2000 miles of service.

Off-The-Road Service: Initial flush and oil change after 24 hours of service, but not to exceed 100 hours of service.

Scheduled flush and oil change every 30 days after initial oil change.

Check oil every 24 hours of service.

Prolonged Low RPM or Stationary Operation: For cases of prolonged low RPM (below 1000 RPM input to transfer case) or prolonged stationary operation, a lube pump is recommended. These lube pumps are available on all models of the Spicer Heavy Duty Transfer Cases.

## REFILL

First, remove all dirt around the filler plug. Then refill with new oil of grade recommended for the existing season and prevailing service. Fill to the bottom of the plug hole on the side or front of the transfer case, depending on mounting (see illustration below).

## OVERFILLING

Do not overfill the transfer case. Overfilling usually results in oil breakdown due to excessive heat and aeration from the churning action of the gears. Early breakdown of the oil will result in heavy varnish and sludge deposits that plug up oil ports and build up on splines and bearings.

## LUBRICANT LEVEL

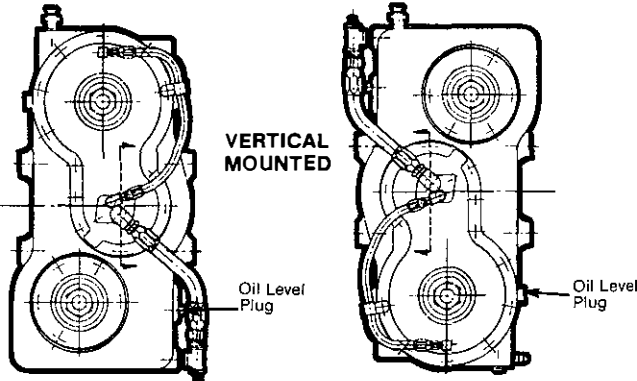

Oil level plugs in line with lower shaft

Oil Capacity —  
11 Pints Approx.

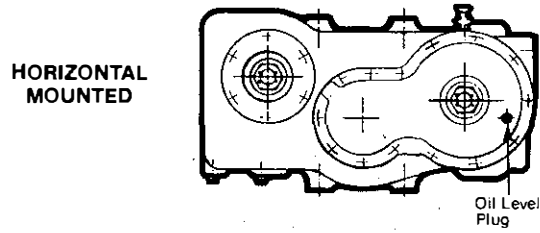

TEMPERATURE	GRADE	TYPE
Above 0° F.	SAE 50	Heavy Duty Engine Oil Meeting MIL-L-2104F or MIL-L-46152
Below 0° F.	SAE 30	NOTE: Oils Meeting MIL-L-2104B or MIL-L-45199 Are Also Acceptable
Above 0° F.	SAE 90	Straight Mineral Gear Oil — R & O Type
Below 0° F.	SAE 80	



## EARLY DESIGN OUTPUT with DISCONNECT

(SEE PAGE 10 FOR LATER DESIGN)

### LESS SHIFTER

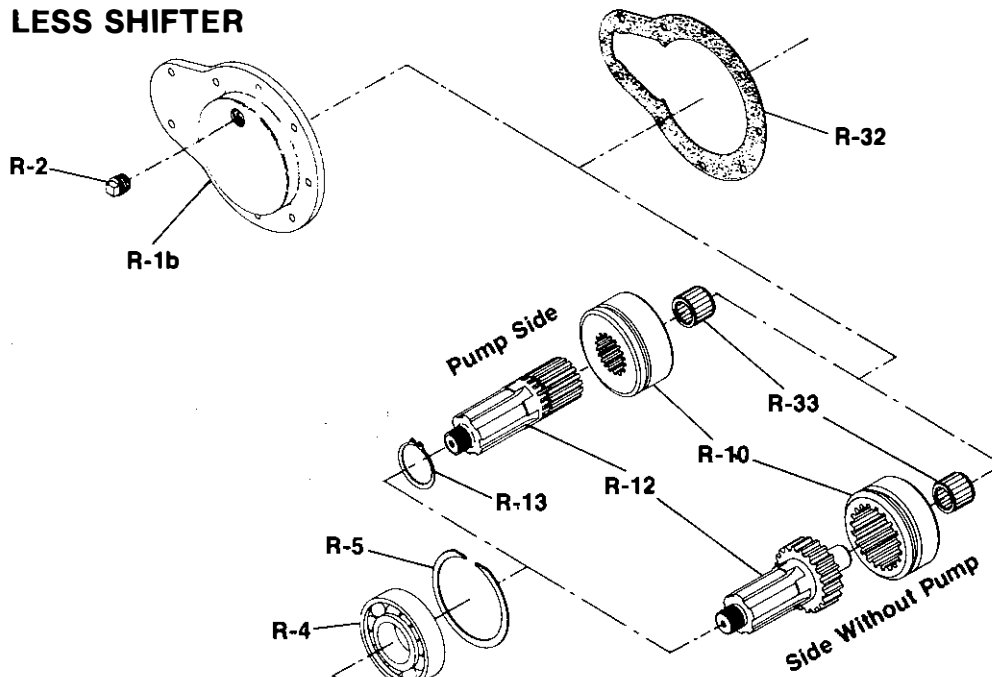

### AIR SHIFT

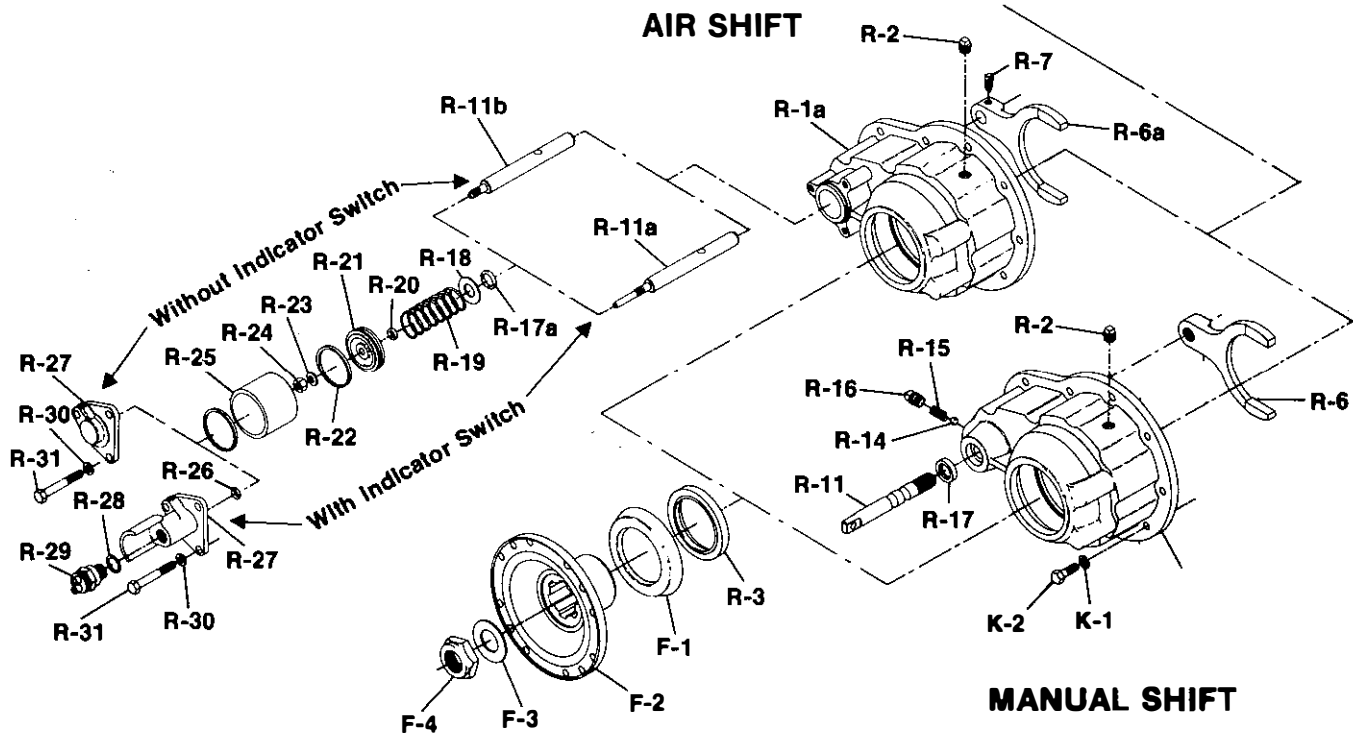

### MANUAL SHIFT

Ref. No.	Part Description
R-1	Cap—disconnect housing & bearing (manual)
R-1a	Cap—disconnect housing & bearing (air)
R-1b	Cap—disconnect housing & bearing (less shifter)
R-2	Plug—disconnect cap
R-3	Oil Seal—output shaft
R-4	Bearing—ball Snap Ring
R-6	Shifter Fork—manual
R-6a	Shifter Fork—air
R-7	Bolt— $\frac{3}{8}$ "-24 x 2" - self locking
R-10	Clutch Collar—disconnect sliding
R-11	Shifter Rod—manual
R-11a	Shifter Rod—air (with indicator switch)
R-11b	Shifter Rod—air (without indicator switch)
R-12	Disconnect Shaft
R-13	Snap Ring
R-14	Ball—poppet
R-15	Spring—poppet ball
R-16	Plug—poppet ball $\frac{5}{8}$ -18 UNF
R-17	Seal—shifter rod
R-17a	"O" Ring
R-18	Washer—return spring retainer
R-19	Spring—return
R-20	"O" Ring—piston
R-21	Piston—air shift
R-22	"O" Ring—piston
R-23	Washer—shifter rod Nut— $\frac{3}{8}$ "-24 Cylinder—air shift
R-26	"O" Ring—cylinder cap (with indicator switch)
R-27	Cylinder Cap—(with indicator switch)
R-27	Cylinder Cap—(without indicator switch)
R-28	Gasket Assembly—indicator switch
R-29	Indicator Switch Assembly
R-30	Lockwasher— $\frac{3}{8}$ "
R-31	Bolt— $\frac{3}{8}$ "-16 x 3" hex head
F-3	Washer
F-4	Nut—self locking
R-32	Gasket—bearing & disconnect cap
<b>NOTE: PARTS LISTED ARE NOT PART OF ASSEMBLIES</b>	
K-1	Lockwasher— $\frac{3}{8}$ "
K-2	Bolt— $\frac{3}{8}$ "-16 x 1 $\frac{1}{4}$ " hex head
F-1	Slinger
F-2	Companion Flange or End Yoke Bearing—disconnect roller

## LATE DESIGN OUTPUT with DISCONNECT

(SEE PAGE 8 FOR EARLIER DESIGN)

### LESS SHIFTER

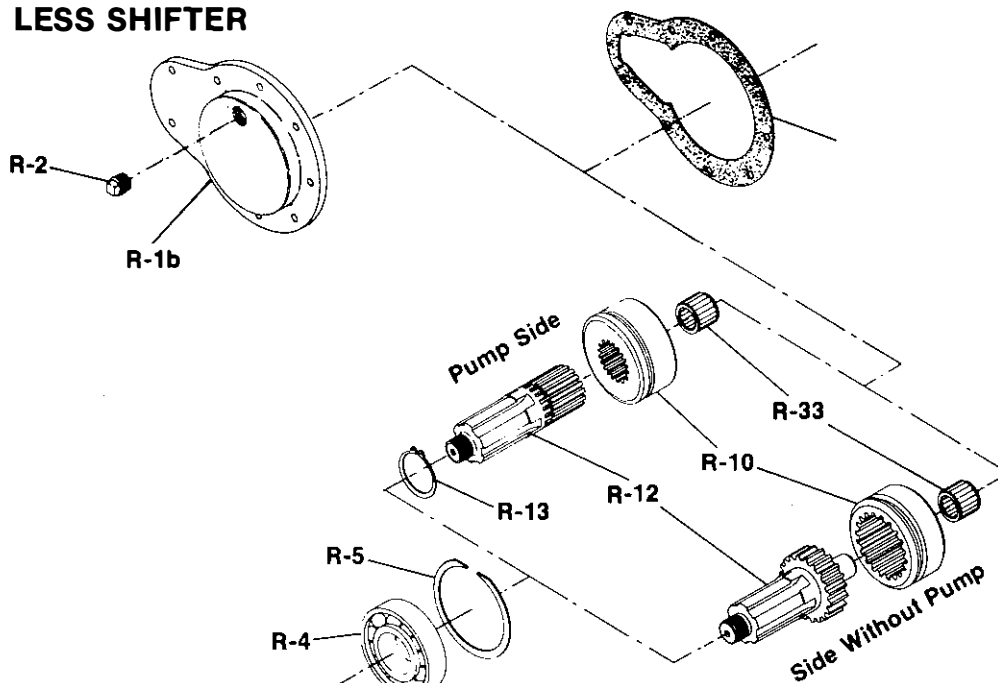

### AIR SHIFT

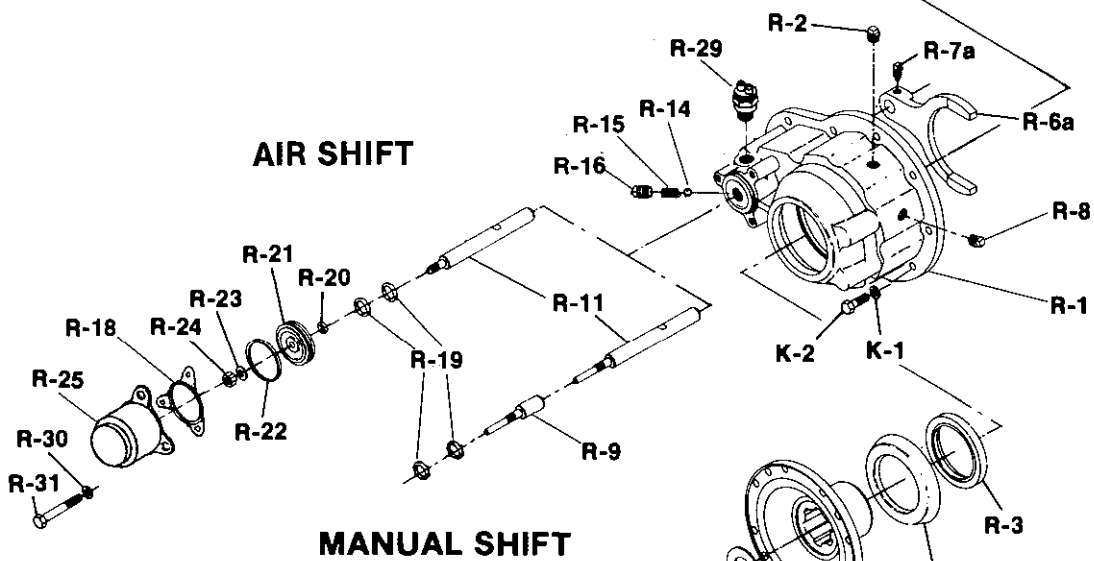

### MANUAL SHIFT

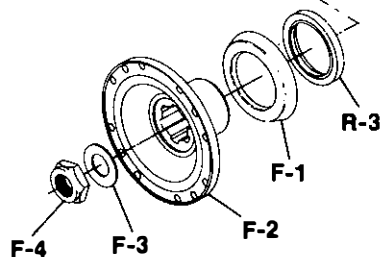

# LATE DESIGN OUTPUT with DISCONNECT

# Spicer®

Ref. No.	Part Description
R-1	Cap—disconnect housing & bearing
R-1b	Cap—disconnect housing & bearing (less shifter)
R-2	Plug—disconnect cap
	Oil Seal—output shaft
R-4	Bearing Ball
R-5	Snap Ring
	Shifter Fork
	Bolt $\frac{3}{8}$ "-24 x $\frac{9}{16}$ "-self locking
	Plug—Pipe $\frac{1}{2}$ -14
R-9	Clevis—manual shift
R-10	Clutch Collar—disconnect sliding
R-11	Shifter Rod
R-12	Disconnect Shaft
R-13	Snap Ring
R-14	Ball—poppet
R-15	Spring—poppet ball
R-16	Plug—poppet ball $\frac{5}{8}$ -18 UNF
R-18	Gasket—oil seal
R-19	"O" Ring Seal
R-20	"O" Ring Seal
R-21	Piston—air shaft
R-22	"O" Ring—piston
R-23	Washer—shifter rod
R-24	Nut— $\frac{3}{8}$ "-24
R-25	Cap—shift cylinder
N.S.	Plug—shipping
R-29	Indicator Switch Assembly
R-30	Lockwasher— $\frac{3}{8}$ "
R-31	Bolt— $\frac{3}{8}$ "-16x3" hex head
F-3	Washer
F-4	Nut—self locking
R-33	Bearing—disconnect roller
<b>NOTE: PARTS LISTED ARE NOT PART OF ASSEMBLIES</b>	
K-1	Lockwasher— $\frac{3}{8}$ "
K-2	Bolt— $\frac{3}{8}$ "-16x1 $\frac{1}{4}$ " hex head
F-1	Slinger
F-2	Companion Flange or End Yoke
R-32	Gasket—bearing & disconnect cap

## TRANSFER CASE DIRECT MOUNT CASE and GEARS

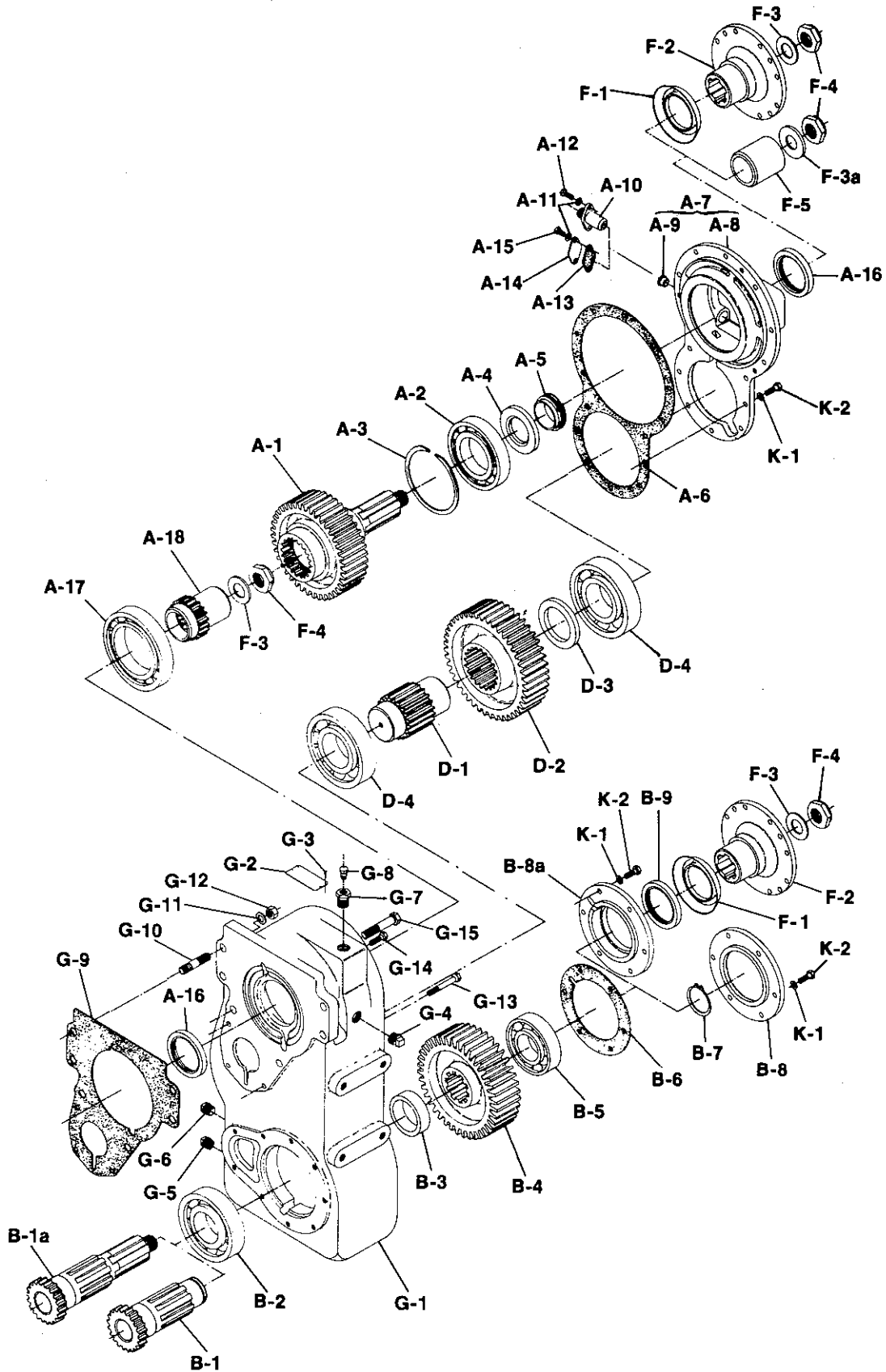

# TRANSFER CASE DIRECT MOUNT CASE and GEARS

# Spicer®

Ref. N	Part Description
A-1	Gear and Shaft—input
A-2	Bearing—input
A-4	Snap Ring Spacer—input Speedometer Gear Set
A-6	Gasket—bearing cap
A-7	Bearing Cap & Speedometer Bushing Assembly
A-8	Bearing Cap Bushings—speedometer
A-10	Sleeve—speedometer
A-11	Lockwasher— $\frac{5}{16}$ "
A-12	Bolt— $\frac{5}{16}$ "-18 x $\frac{7}{8}$ "
A-13	Gasket—speedometer cover
A-14	Cover—speedometer
A-15	Bolt— $\frac{5}{16}$ "-18 x $\frac{5}{8}$ "
A-16	Oil Seal
A-17	Bearing—input
A-18	Coupler—input shaft
B-1	Shaft—closed end
B-1a	Shaft—with output
B-2	Bearing—ball Spacer—output shaft
B-4	Gear—output shaft (40T) Bearing—ball
B-6	Gasket
B-7	Snap Ring
B-8	Bearing Cap—closed end
B-8a	Bearing Cap—with output shaft
B-9	Oil Seal
D-1	Shaft—intermediate
D-2	Gear—intermediate
D-3	Spacer—intermediate
D-4	Bearing—intermediate
F-1	Slinger
F-2	Companion Flange or End Yoke
F-3	Flat Washer—with Flange or End Yoke
F-3a	Flat Washer—with spacer
F-4	Nut— $1\frac{1}{4}$ "-18" self locking
F-5	Spacer—without Flange or End Yoke
G-1	Case—direct mount
G-2	Nameplate Pin-nameplate
G-4	Plug—breather hole
G-5	Plug—magnetic drain $\frac{1}{2}$ -14 N.P.T.F.
G-6	Plug—Filler
G-7	Reducer Bushing—breather
G-8	Breather
G-9	Gasket—mounting
G-10	Stud— $\frac{5}{8}$ "-11 & $\frac{5}{8}$ "-18 x $2\frac{7}{8}$ "
G-11	Lockwasher
G-12	Nut— $\frac{5}{8}$ "-18
G-13	Bolt— $\frac{3}{8}$ "-16 x $1\frac{1}{4}$ " self locking
G-14	Bolt— $\frac{5}{8}$ "-11 x $3\frac{1}{4}$ " self locking
G-15	Bolt— $\frac{3}{8}$ "-16 x $2\frac{3}{4}$ " self locking
K-1	Lock Washer— $\frac{3}{8}$ "
K-2	Bolt— $\frac{3}{8}$ "-16 x $1\frac{1}{4}$ " hex head

## TRANSFER CASE REMOTE MOUNT CASE and GEARS

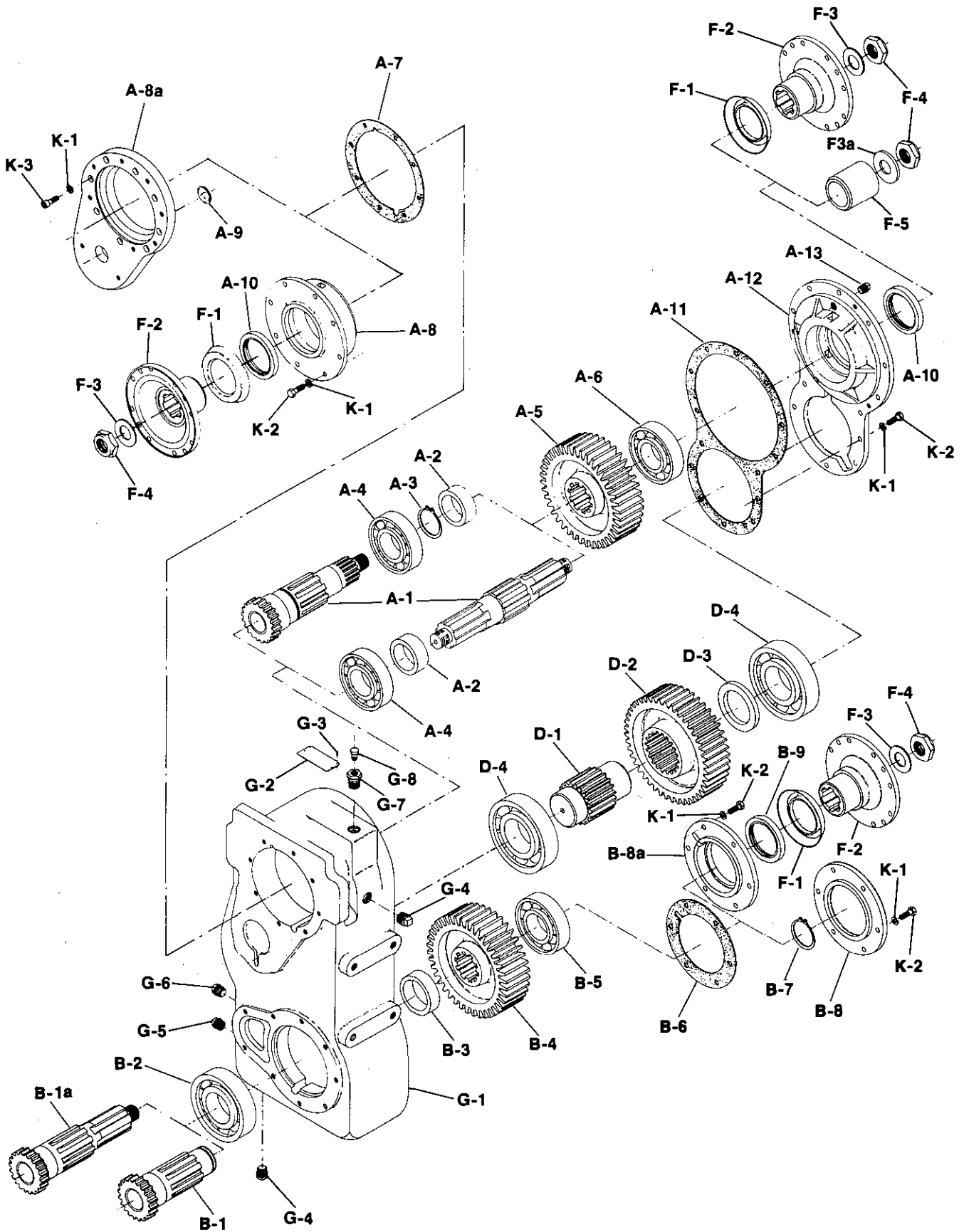

# TRANSFER CASE

## REMOTE MOUNT CASE and GEARS

Ref. No.	Part Description
A-1	Input Shaft
A-2	Input Shaft Spacer
A-3	Snap Ring
A-4	Bearing Input Shaft
A-5	Gear Input Shaft
A-6	Bearing Input Shaft
A-7	Gasket
A-8	Cap-Bearing
A-8a	Adapter
A-9	Expansion Ring
A-10	Oil Seal
A-11	Gasket
A-12	Bearing Cap
A-13	Oil Level Plug—horizontal mount
B-1	Shaft—closed end
B-1a	Shaft-with output
B-2	Bearing Output Shaft
B-3	Spacer Output Shaft
B-4	Gear Output Shaft
B-5	Bearing Output Shaft
B-6	Gasket
B-7	Snap Ring
B-8	Bearing Cap—without output shaft
B-8a	Bearing Cap—with output shaft
B-9	Oil Seal
D-1	Shaft Intermediate
D-2	Gear Intermediate Shaft
D-3	Spacer Intermediate Shaft
D-4	Bearing Intermediate Shaft
F-1	Slinger
F-2	Companion Flange
F-3	Flat Washer—with flange or end yoke
F-3a	Flat Washer
F-4	Nut
F-5	
G-1	Case Remote Mount
G-2	Name Plate
G-3	Pin—name plate
G-4	Plug Breather Hole
G-5	Plug Magnetic Drain
G-6	Plug Filler
G-7	Reducer Bushing—breather
G-8	Breather
K-1	Lockwasher
K-2	Bolt—hex head
K-3	Bolt—socket head

N.S.—Not Shown



## TRANSFER CASE LUBE PUMP, HOSES and FITTINGS

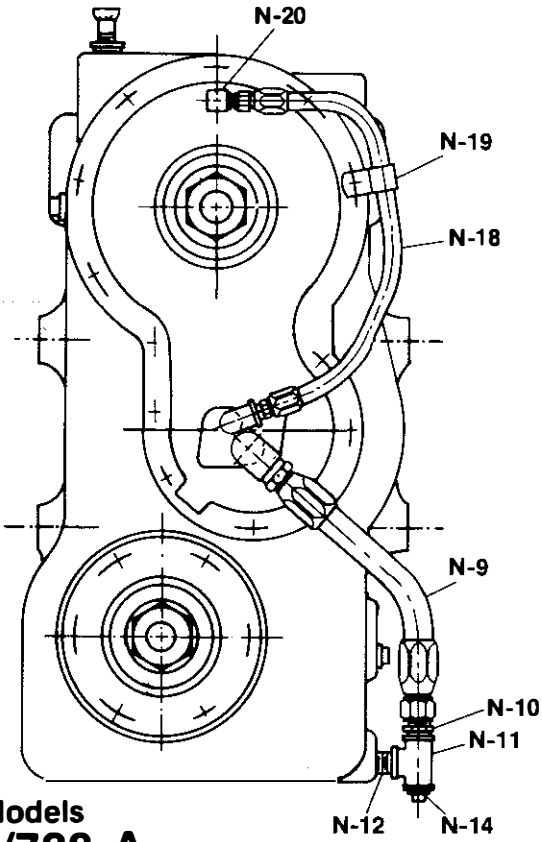

**Models  
738/738-A**

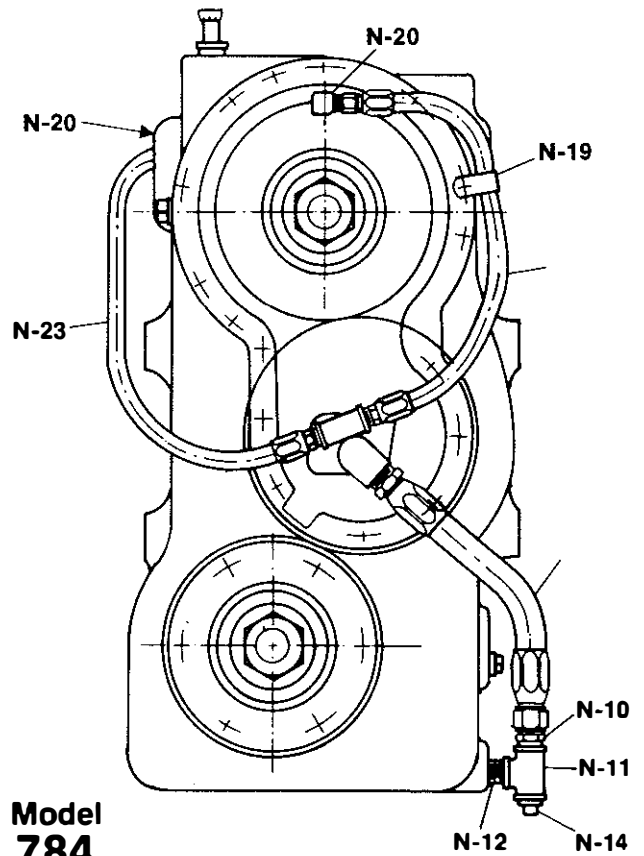

**Model  
784**

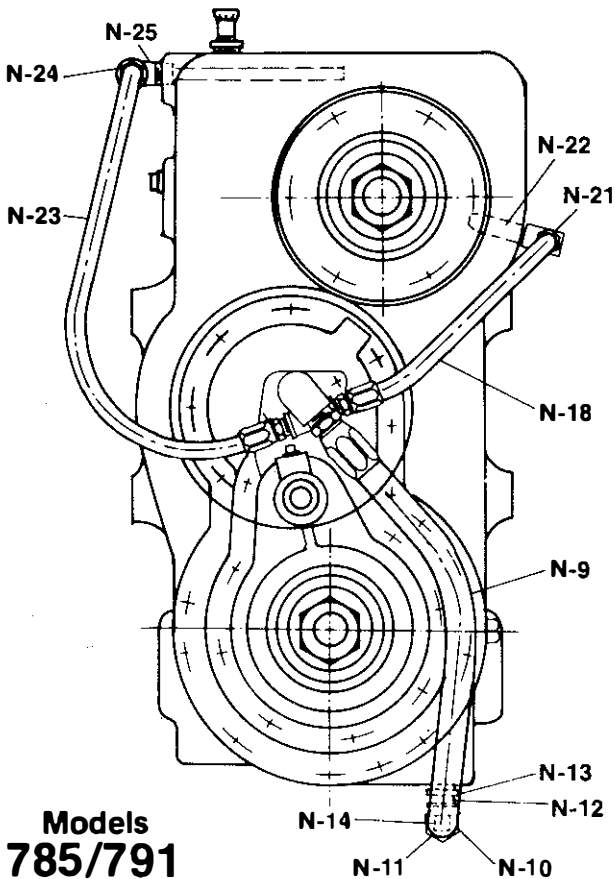

**Models  
785/791**

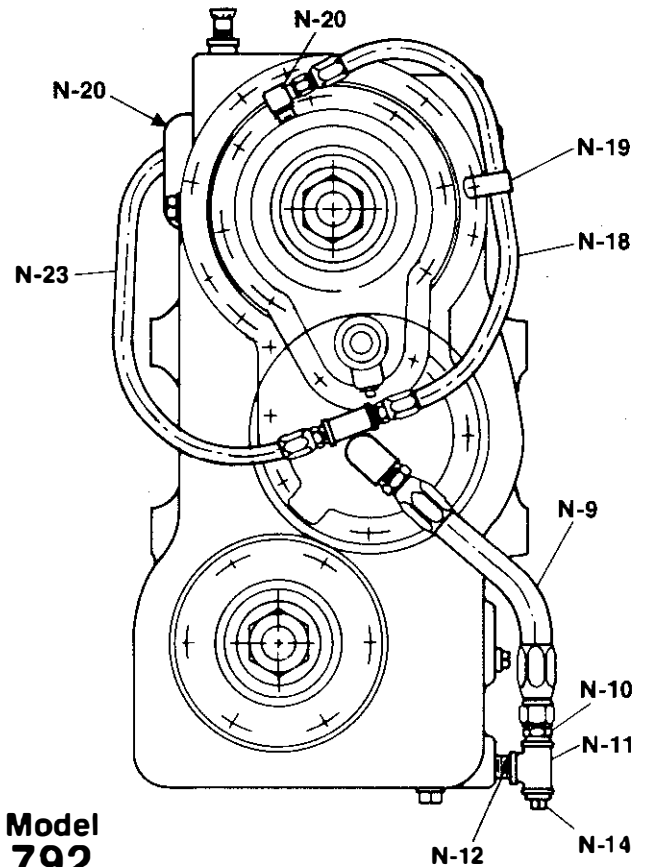

**Model  
792**

# TRANSFER CASE LUBE PUMP, HOSES and FITTINGS

# Spicer®

Ref. No.	Part Description
	Bearing Cap—lube pump
	Spacer—intermediate shaft & bearing
	Shim—drive screw (.010")—as required
	Shim—drive screw (.050")—as required
N-3	Drive Screw—pump 1/2-13 x 1"
	Coupling—drive screw to pump
N-4	Gasket—bearing cap to pump
N-5	Pump
N-6	Bolt—5/16"-18 x 3 3/4"
<b>INLET</b>	
N-7	Pipe Nipple—3/4"-14 x 2 1/2" (With inline filter)
N-8	90° Elbow—3/4"-14 N.P.T. Hose Assembly
N-10	Male Connector—1/2"-14 to 7/8"-14
N-11	Pipe Tee—1/2"-14
N-12	Pipe Nipple—1/2"-14 x 1 1/8"
N-13	Reducer Bushing—3/4"-14 to 1/2"-14
N-14	Drain Plug—magnetic 1/2-14 N.P.T.F.
<b>1st - OUTLET</b>	
N-15	90° Elbow—3/8"-18 N.P.T.
N-16	Pipe Nipple—3/8"-18 x 1" N.P.T.
N-17	Pipe Tee—3/8"-18 N.P.T.
N-18	Hose Assembly
N-19	Support Clamp
N-20	90° Hose Adaptor—3/8"-18 to 9/16"-18
N-21	Hose Adaptor—3/8"-18 to 9/16"-18
N-22	Pipe Nipple—3/8"-18
<b>2nd - OUTLET</b>	
N-23	Hose Assembly
N-24	Male Connector—1/2"-14 to 9/16"-18
N-25	Tube and Street Elbow Assembly

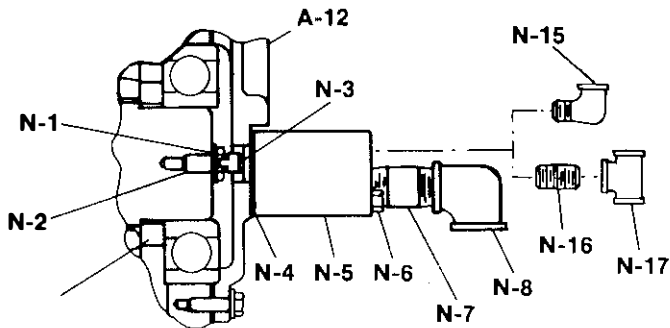

---

# General Precautions for Disassembly

---

## IMPORTANT

Read this section before starting the detailed disassembly procedure.

Follow each procedure closely in each section, making use of both the text and the pictures.

## REBUILD FACILITIES

A suitable holding fixture or overhaul stand is desirable but not necessary to rebuild this unit.

For easier working conditions, table height should be 28-30 inches. A light chain hoist should be used to handle the transfer case during disassembly and reassembly procedures.

## CLEANLINESS

The transfer case should be steam cleaned prior to disassembly. Seal all openings before steam cleaning to prevent entry of dirt and water which can damage serviceable parts.

Dirt is abrasive and will cause premature wear of bearings and other parts. We suggest that mechanics have a small wash tank to clean parts just prior to reassembly.

## BEARINGS

Bearings should be removed with pullers designed for this purpose. Wrap the bearings to keep out dirt. Clean, inspect, and lubricate all bearings just prior to reassembly. If accumulated mileage is over 150,000 miles we suggest that all bearings be replaced.

## END YOKES & FLANGES

Hammering on end yokes and flanges to remove or install them is not only destructive to the yoke or flange itself, but can also cause serious internal damage. Hammering destroys or mutilates the pilot diameters and warps or bends the flange. Hammering on end yokes will close-in the bearing bores or misalign yoke lugs and result in early failure of journal needle bearings, etc.

Serious damage can be done internally to bearings, thrust faces and washers, etc. by hammering on external parts.

In most designs, when the yoke/flange locknuts are tightened and secure, the internal bearings and gears are in proper location.

## CLEANING

1. Parts should be cleaned with emulsion cleaners or petroleum based cleaners.

**NOTE: Alkaline type solutions may cause damage to machined surfaces and should be avoided.**

2. Make sure interior of transfer case housing is clean prior to reassembly.

3. Clean all gasket surfaces of old material.

## DRYING

Use soft, clean, lintless towels or rags to dry components after cleaning. Bearings should NOT be dried by spinning with compressed air. This can damage mating surfaces due to lack of lubrication.

After drying, parts should be coated with a light coat of lubricant or rust preventive to prevent damage from corrosion. If parts are to be stored for a prolonged period, they should be wrapped in waxed paper.

## INSPECTION

Prior to reassembly, inspect parts for signs of wear or damage. Replacement of these parts can prevent premature failure and costly downtime.

Bearing surfaces should be inspected for pitting, wear, or overheating.

Inspect gears and clutches for wear or damage. Replace gears that are pitted, scored, or worn.

Inspect shafts for nicks or mars or damaged threads.

---

**Safety Glasses should be worn at all times when assembling or disassembling.**

---

---

## Preparation for Disassembly

---

1. After removing transfer case from vehicle, clean exterior prior to disassembly. Care should be taken to prevent water from entering assembly.
2. Remove drain plug at bottom of case and drain lubricant.
3. A clean working area is essential. It is important to prevent foreign material from entering assembly during repairs.
4. Position transfer case in a suitable holding fixture or horizontally on table with upper front input and lower front output facing upward or forward.

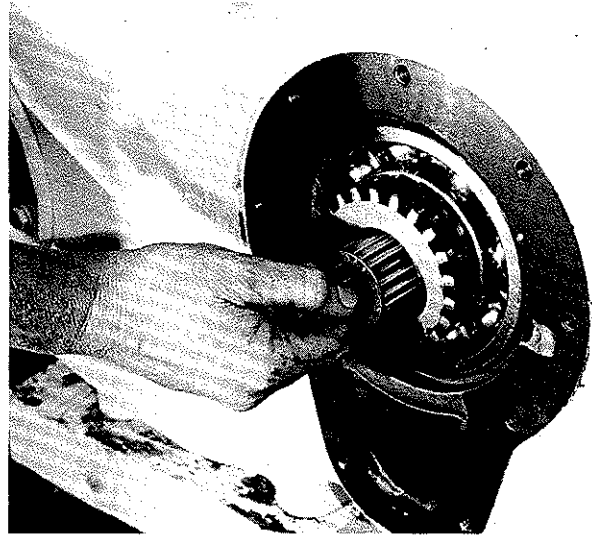

4. Remove needle roller bearing from output shaft.

## Removal of Shift Unit

Depending on the model, the shift unit can be mounted on any one of the output shafts. The removal of each of the shift units will be the same, regardless of the position.

Remove air lines if required.

1. Remove lock nut and washer from output shaft. Remove end yoke or companion flange.
2. Disengage shift unit by pulling the shifter shaft up or out.

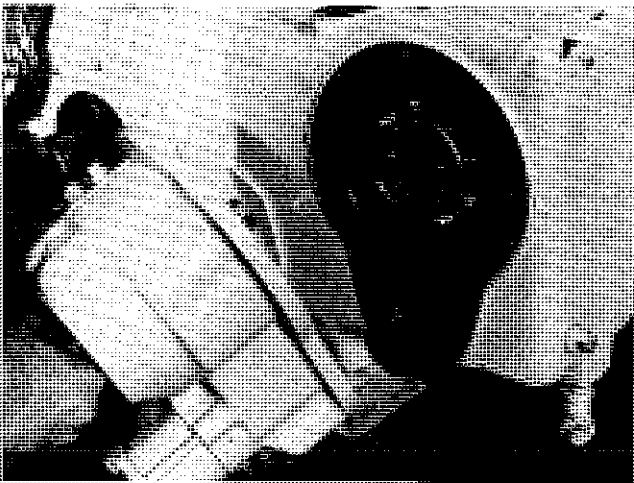

3. Remove nine (9) bolts and lock washers from flange of disconnect. Remove disconnect by lifting straight away from case. Remove gasket and discard.

---

## LUBRICATION PUMP

---

### Removal from Transfer Case

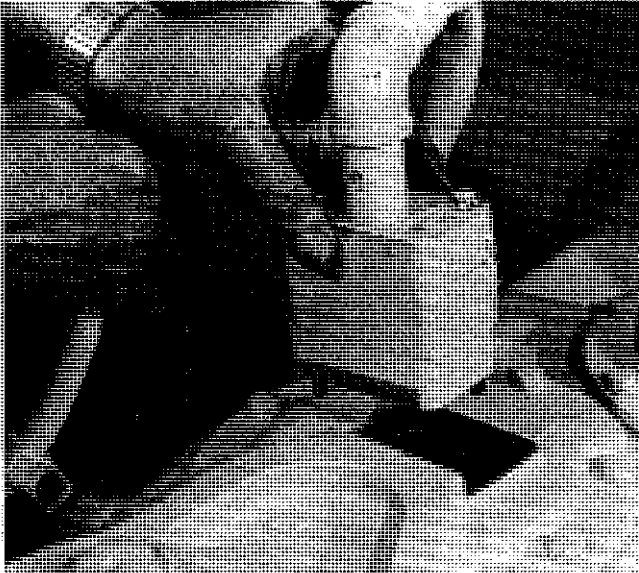

1. Disconnect lubricant hoses from transfer case. Remove two bolts holding lubrication pump and lift pump from housing. Remove old gaskets and discard.

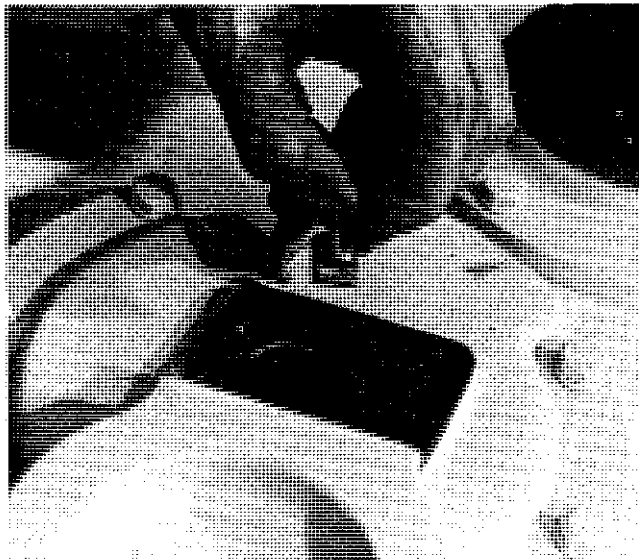

2. Remove drivescrew coupling from housing.

**NOTE:** Lubrication pump is a non-serviceable item. If pump malfunctions internally, it will need to be replaced.

## Disassembly of Air Engaged—Spring Disengaged Shift Unit Early Design

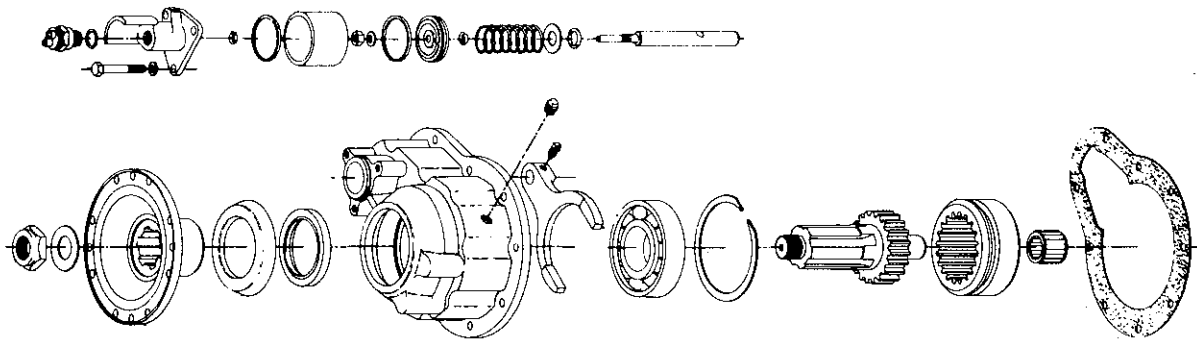

1. Remove locking nut, washer, end yoke or companion flange.

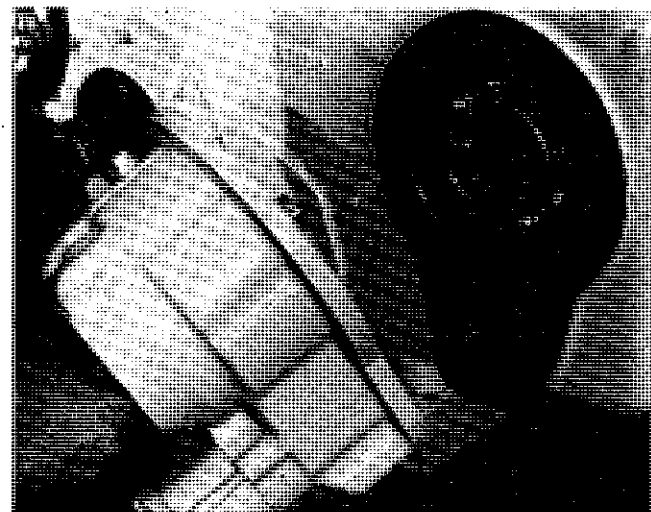

2. Remove unit from transfer case housing.

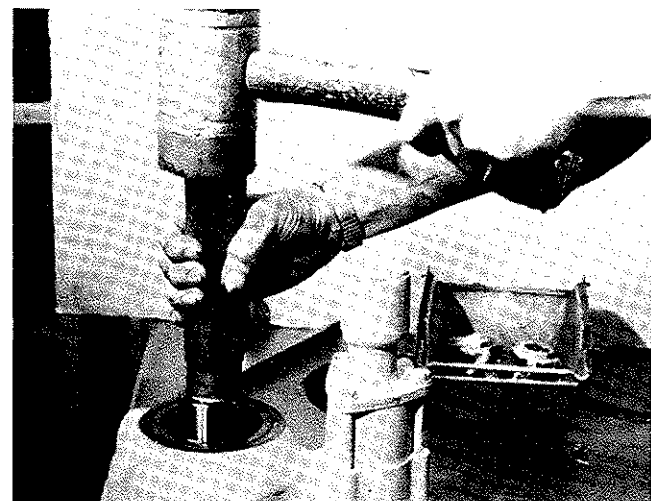

3. Using driver and soft hammer, remove disconnect shaft. Care should be taken to prevent shaft from falling to floor.

4. Remove indicator switch assembly.

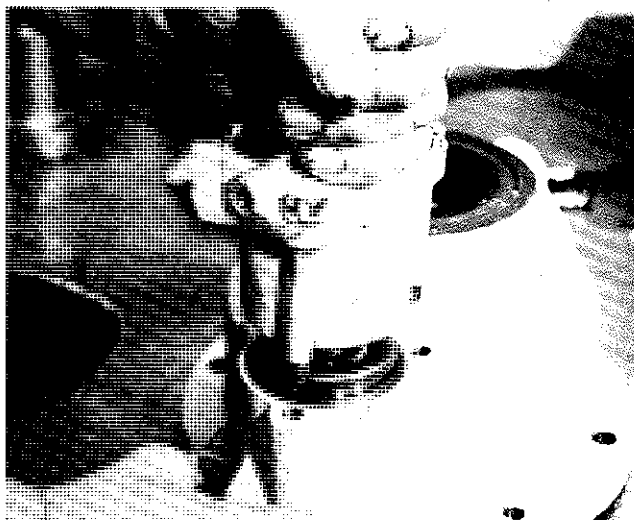

5. Remove three (3) bolts and lockwashers and lift off cylinder cap and cylinder.

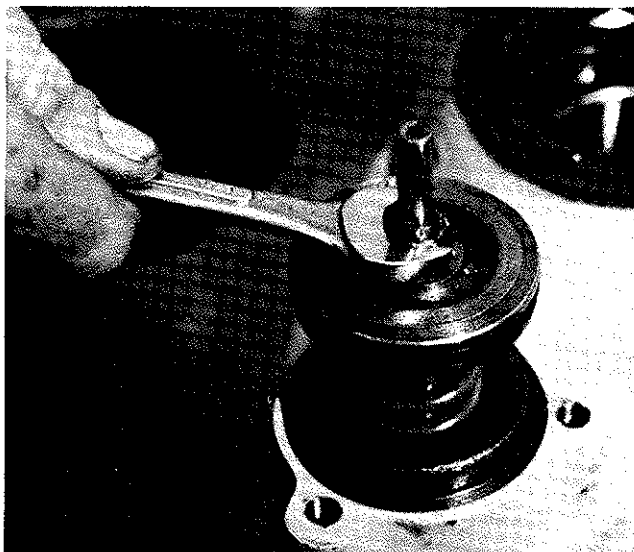

6. Remove locknut and washer from shift fork shaft.

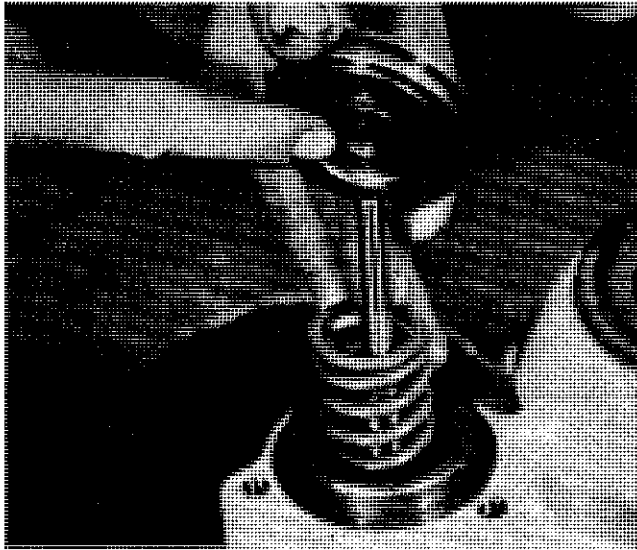

7. Remove piston from shift fork shaft.

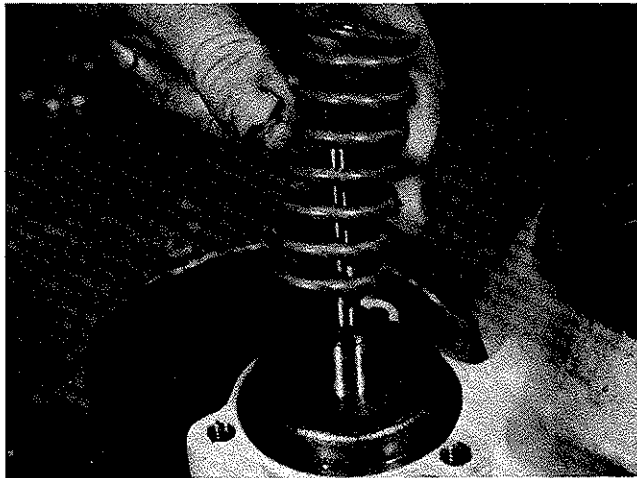

8. Remove spring and "O" ring from shift fork shaft.

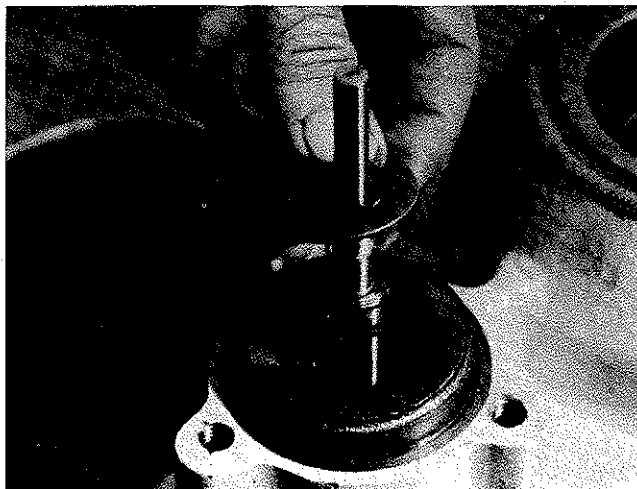

9. Remove spring retainer washer and "O" ring.

**NOTE:** From this point on the procedure for disassembling the disconnect is similar for both the manual shift and the air shift. Remove plug, spring, and poppet ball from manual shift housing.



10. Remove pipe plug and shift fork shaft setscrew. Remove shift fork shaft.

11. Turn assembly over and remove shift fork and clutch collar.

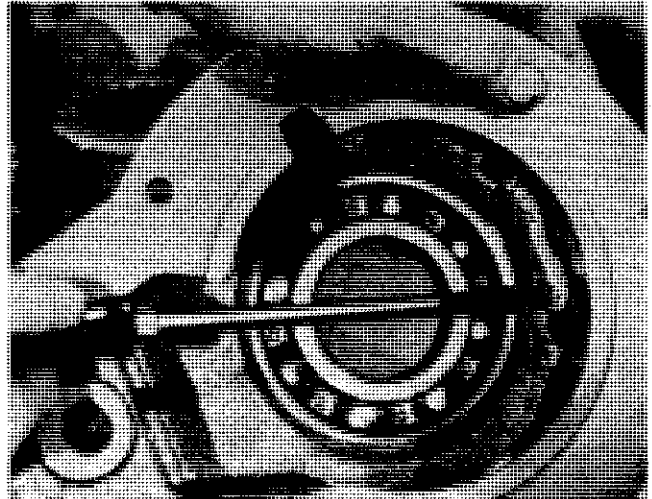

12. Remove bearing retainer snap ring.

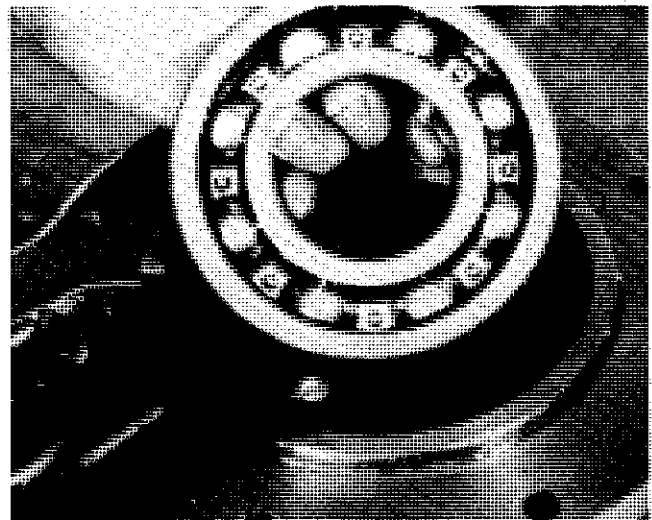

13. Remove bearing and oil seal. Discard oil seal.

# Disassembly Of Air Engaged — Air Disengaged Disconnect And Manual Shift Late Design

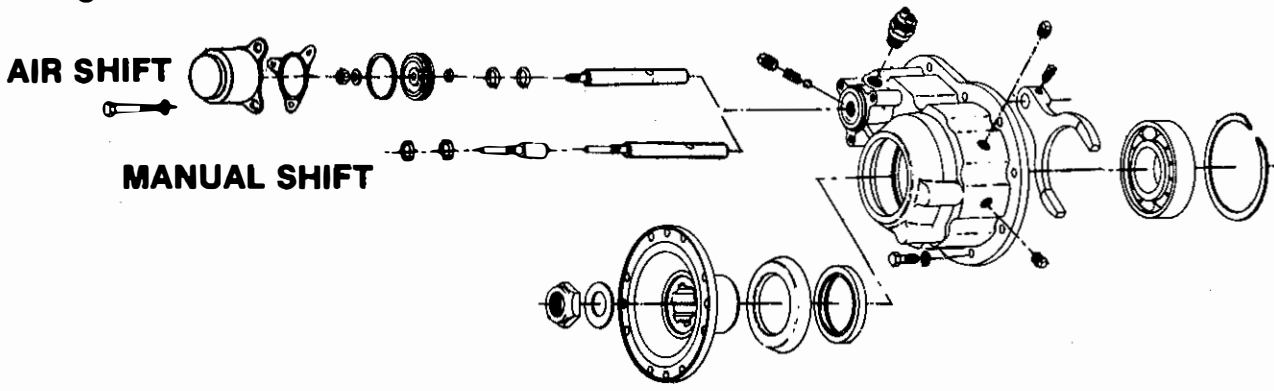

1. Remove locknut and washer disconnect output shaft. Remove end yoke or companion flange.
2. Disengage shift unit by pulling the shifter shaft up or out.

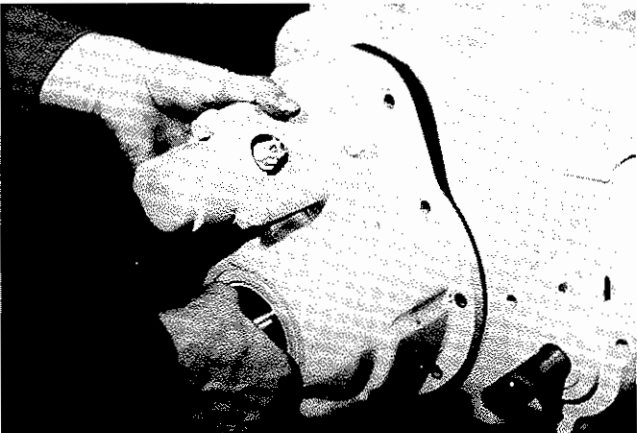

3. Remove (9) bolts and lockwashers from flange of disconnect. Remove disconnect by lifting up and straight away from case. Remove gasket and discard.

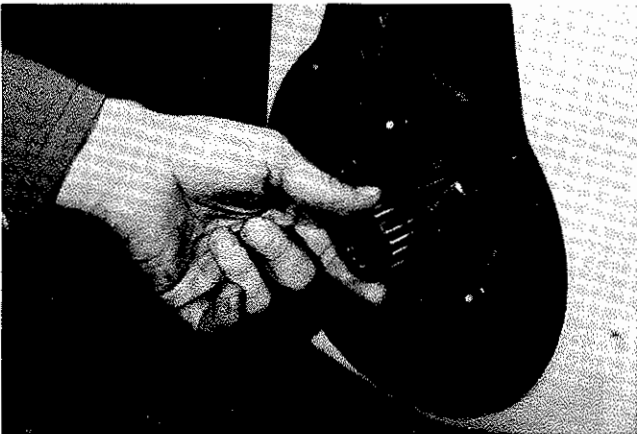

4. Remove needle roller bearing from output bearing from shaft.

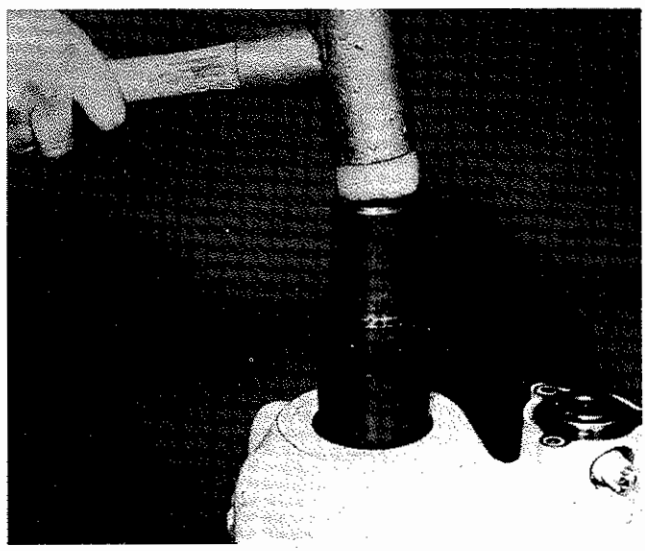

5. Use a press or driver and soft hammer to remove output shaft.

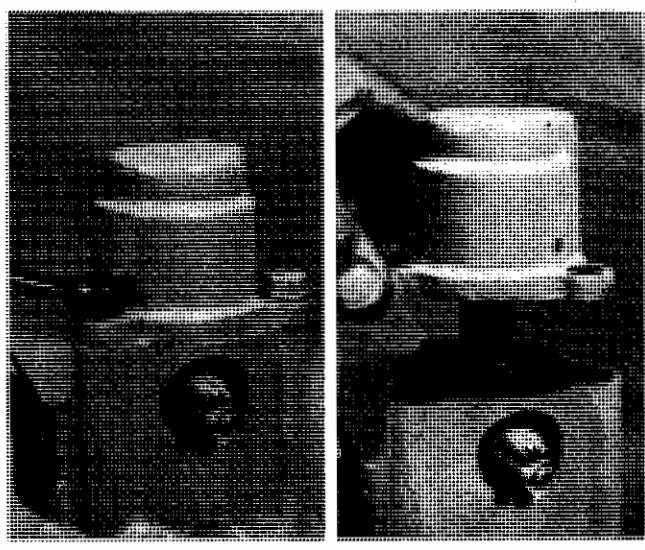

6. Remove (3) bolts and lockwashers and lift off cylinder cap.



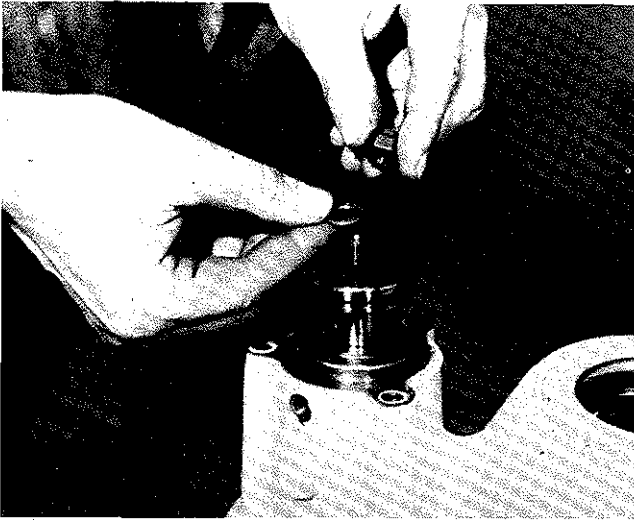

7. Remove locknut and brass washer from shift fork shaft.

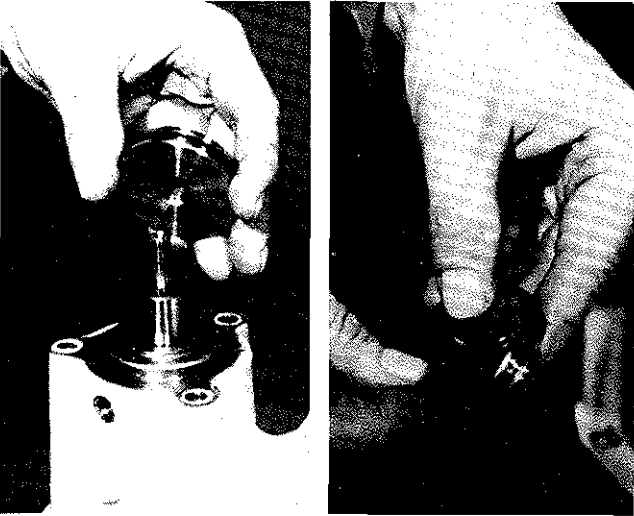

8. Remove piston from shift fork shaft. Remove piston "O" Ring and discard.

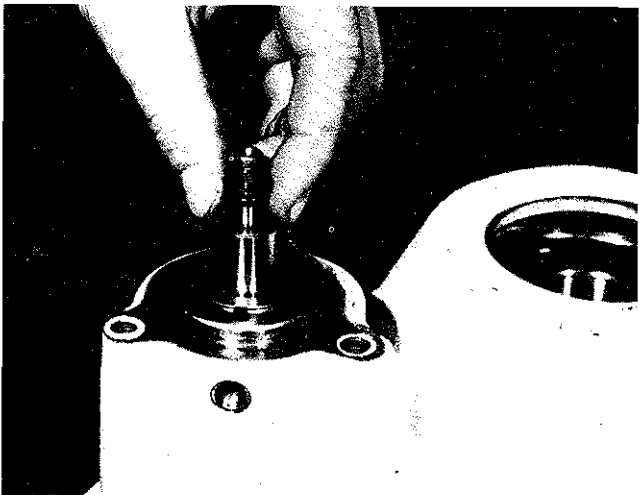

9. Remove "O" Ring from shift fork shaft.  
**NOTE:** From this point on the procedure for disassembling the disconnect is the same for both the manual shift and the air shift.

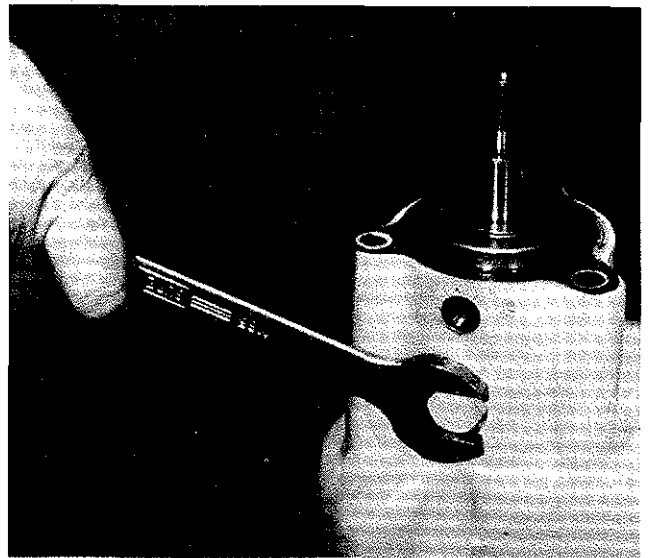

10. Remove hex head poppet plug.

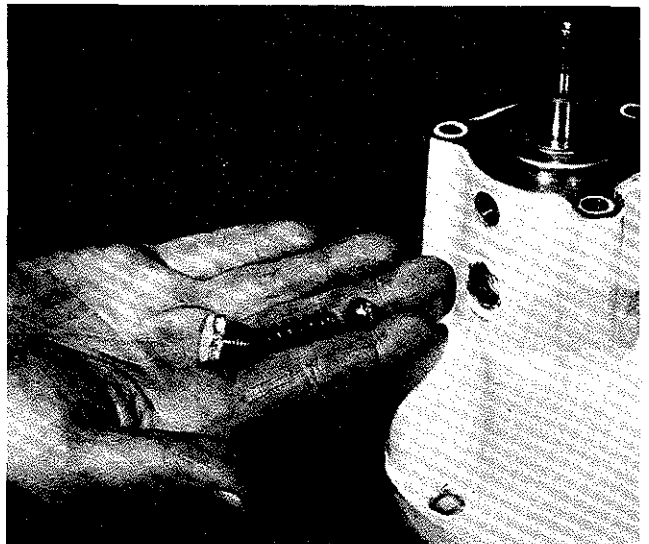

11. Remove spring and poppet ball from assembly.

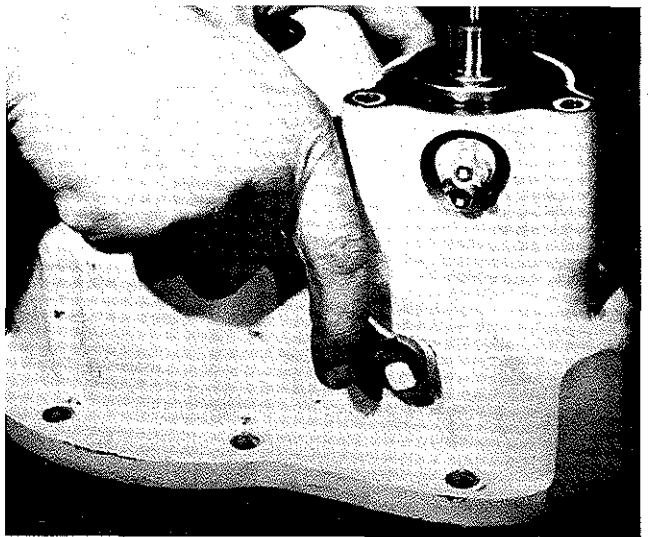

12. Remove square head plug from housing.



13. Use a common screwdriver to remove set screw from shift fork.

14. Remove indicator switch from disconnect housing.

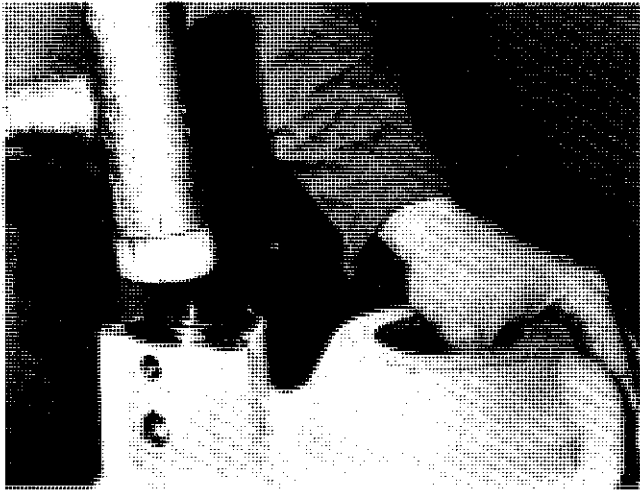

15. Use a soft hammer to tap out shift fork shaft.

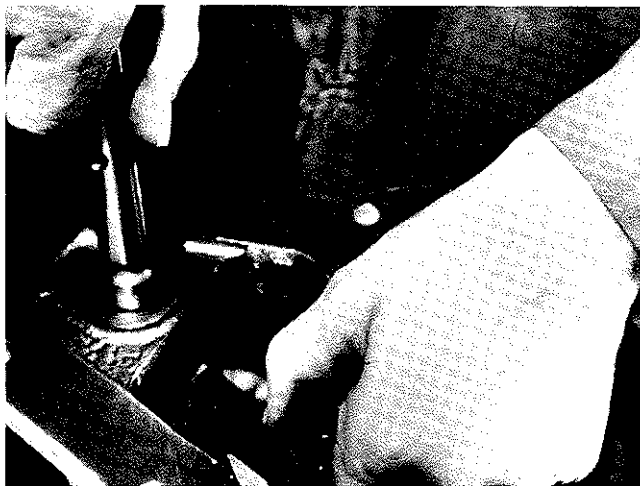

16. Turn assembly over and remove shift fork shaft.

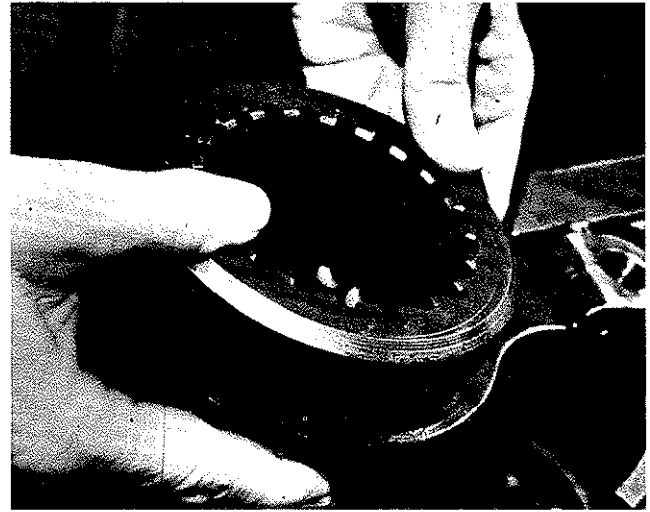

17. Remove clutch collar and shift fork. Inspect clutch collar teeth and shift fork for damage and wear. If shift fork pads show more than .010 inch wear, it should be replaced.

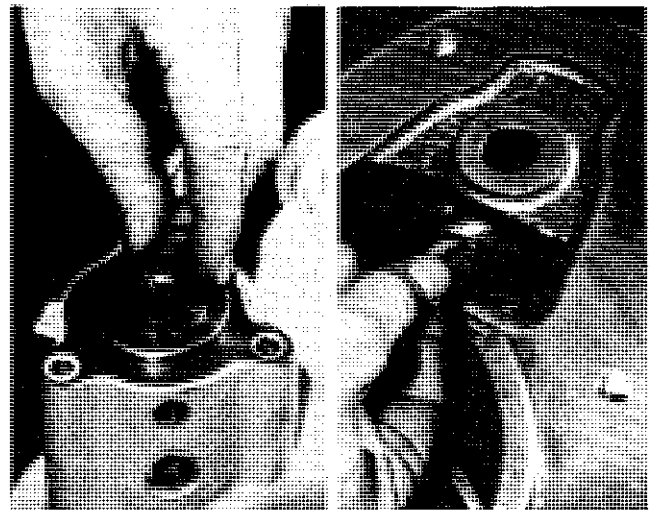

18. Remove (2) "O" Rings from the shift fork shaft inside diameter.

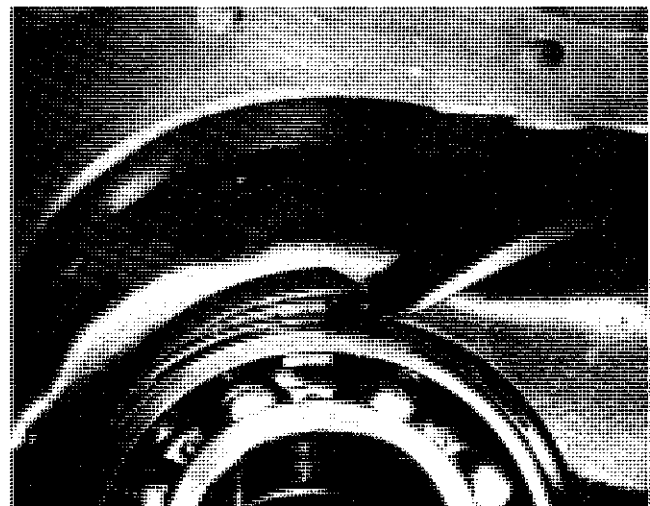

19. Use a common screwdriver to remove bearing retainer snap ring.

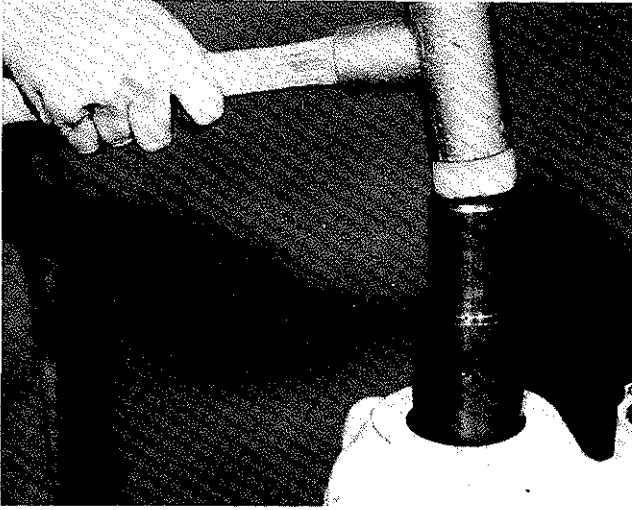

20. Use a driver and soft hammer to remove bearing.

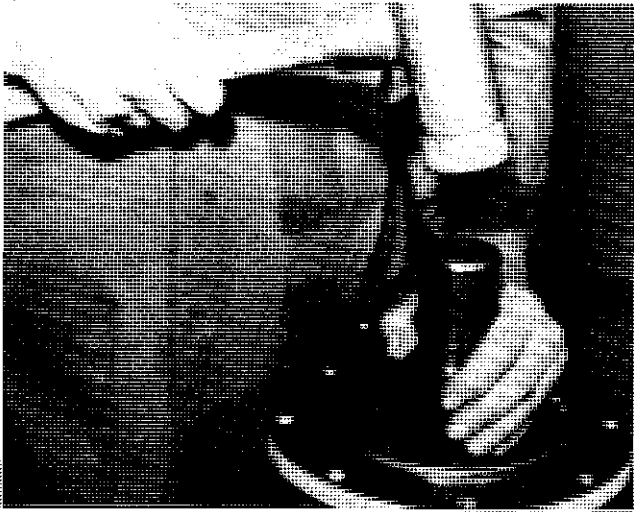

21. Remove seal and discard.

## Upper Shaft Disassembly without Shift Unit

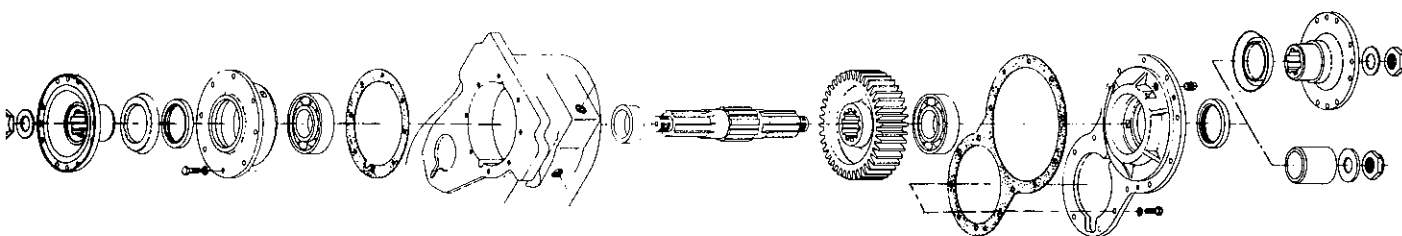

1. Remove locking nut, washer, and companion flange from input shaft.

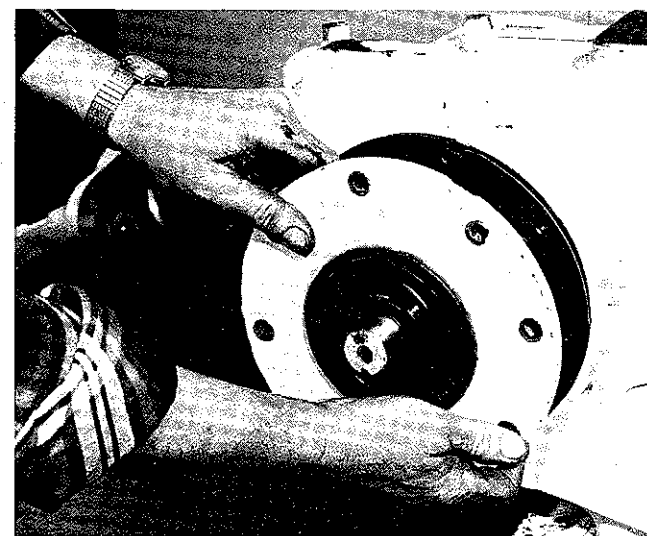

2. Remove eight (8) bolts and lockwashers from bearing cap flange. Remove bearing cap and gasket.

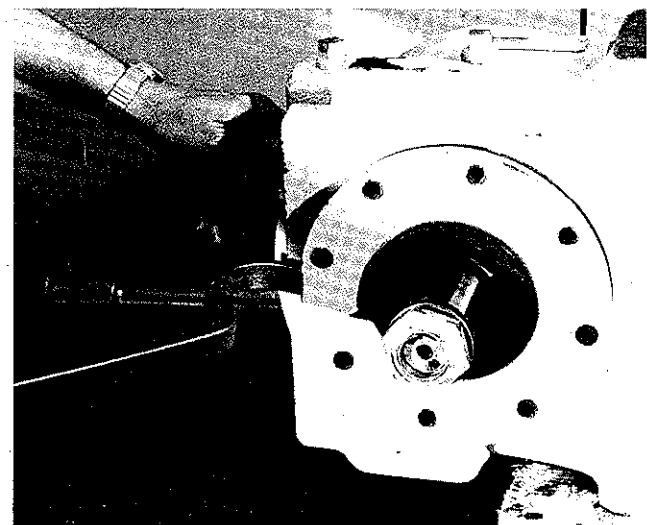

- 2A. NOTE: Bearing cap has a tight fit and a pry bar may be required.

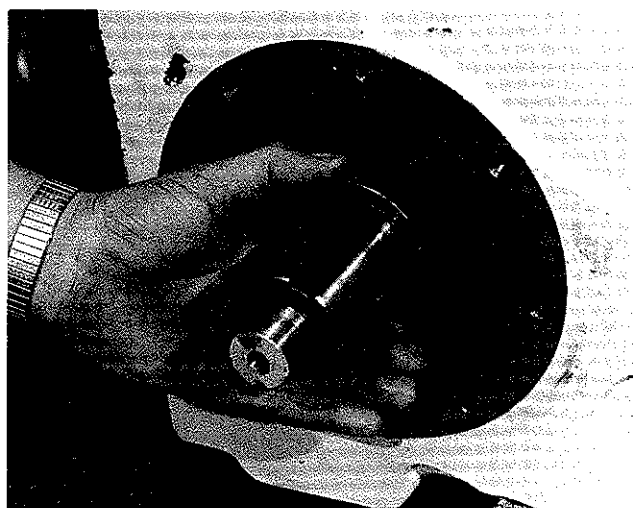

3. Remove spacer from Input shaft.

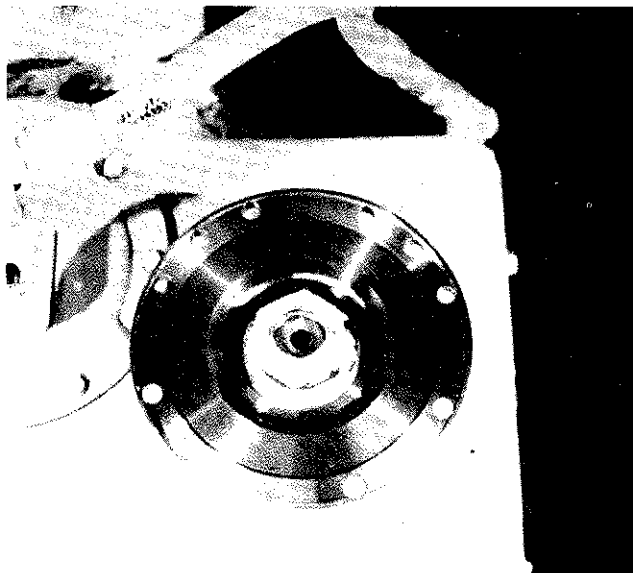

4. Remove locking nut and washer from upper output shaft. Remove end yoke or companion flange, if so equipped.

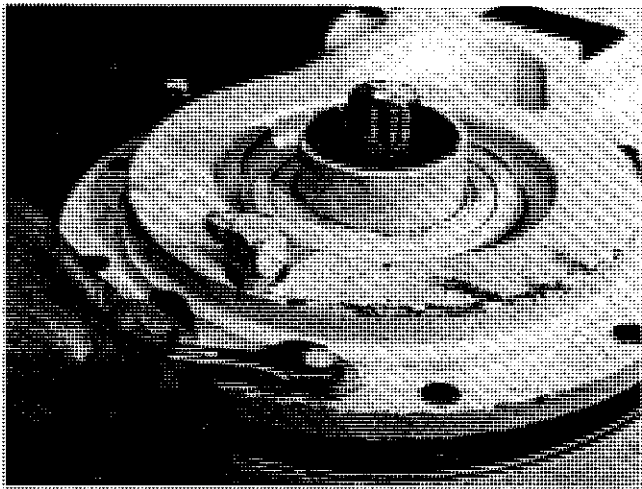

5. Remove fourteen (14) bolts and lockwashers from rear output bearing cap flange. Insert three (3) bolts in the tapped holes in the flange and tighten to break loose bearing cap.

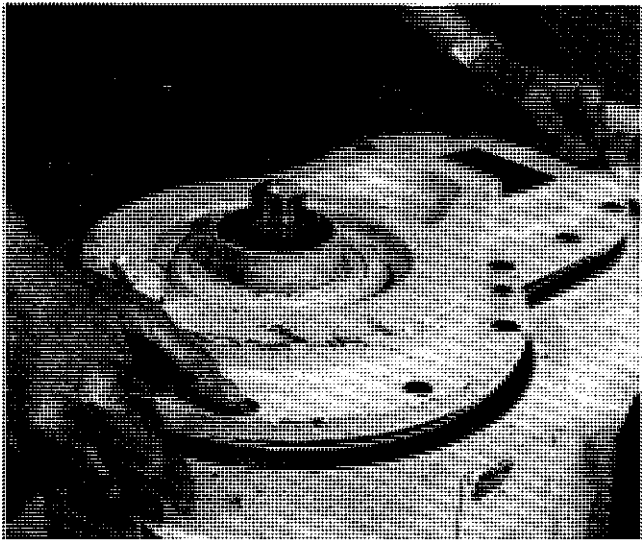

6. Remove bearing cap and gasket.

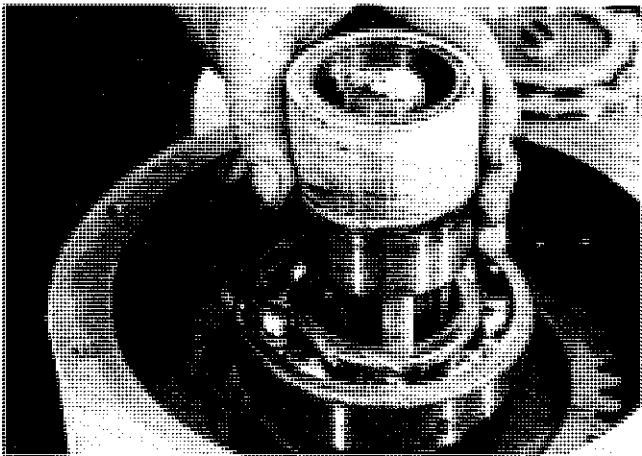

7. Remove spacer from output shaft. This spacer is supplied to take the place of an end yoke or a companion flange.

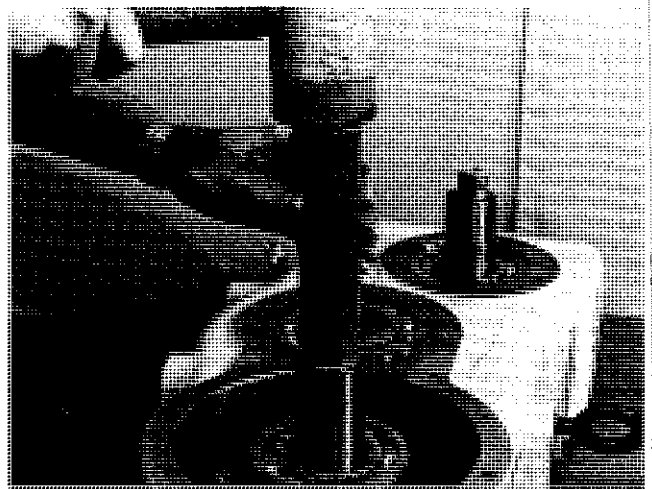

8. Using driver, remove output shaft.

NOTE: Care should be taken to prevent damage to threads or allowing shaft to fall to floor.

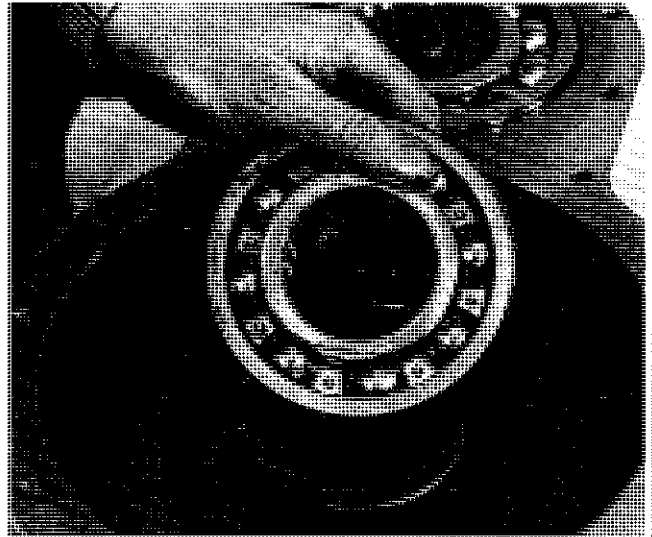

9. Remove bearing from case.

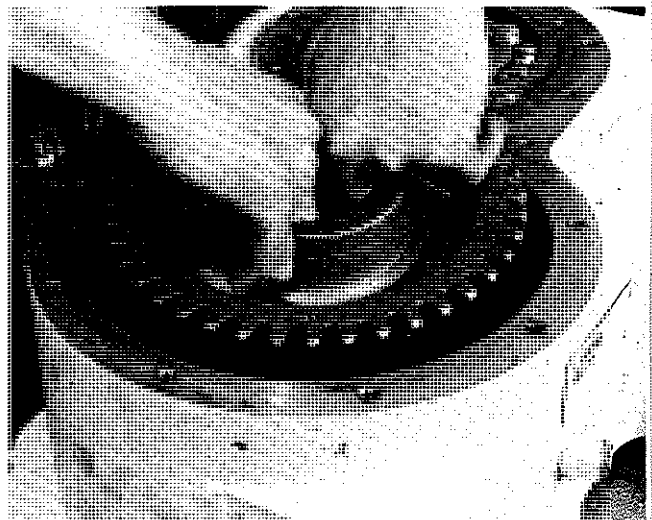

10. Remove gear from case.

## Upper Shaft Disassembly with Shift Unit

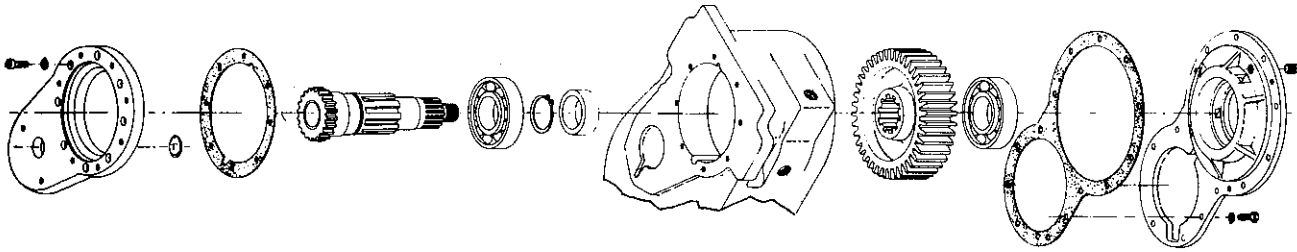

1. Remove shift unit and needle roller bearing as described on page 19.

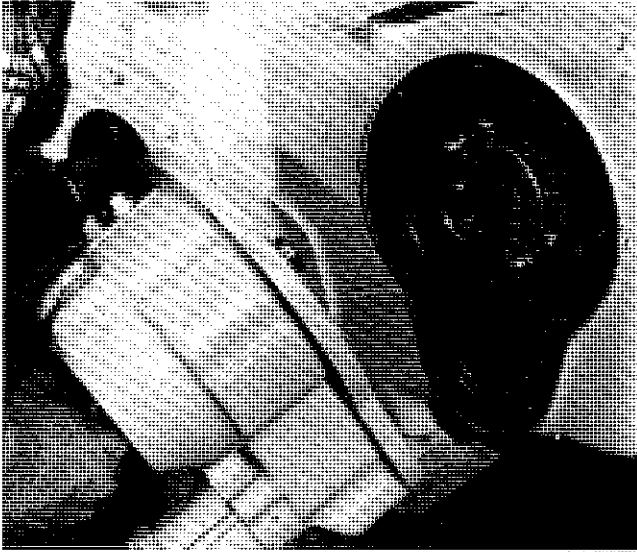

2. Remove adapter plate and gasket.

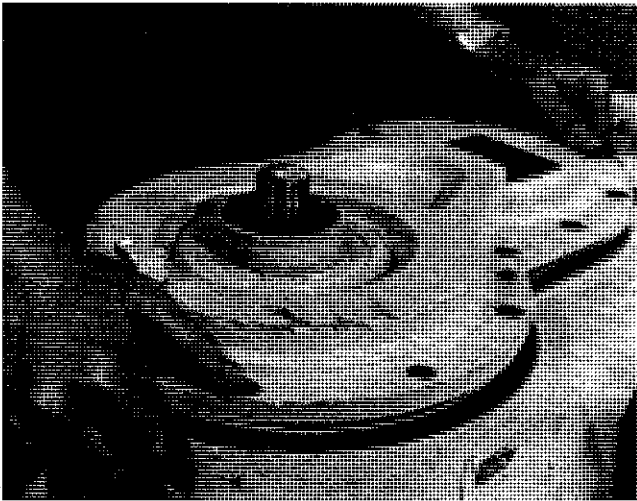

3. Remove the fourteen (14) bolts and lock-washers from rear output bearing cap flange. Insert three (3) bolts in the tapped holes in the flange and tighten to break loose bearing cap.

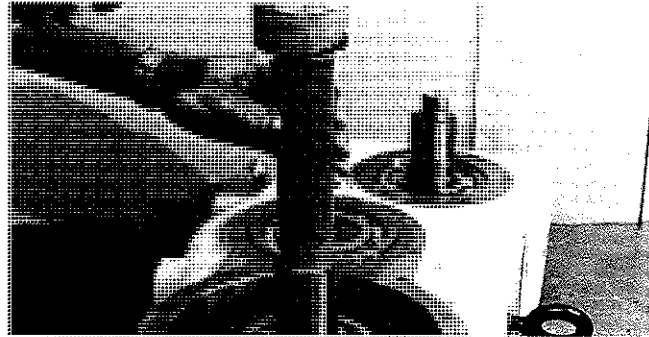

4. Using driver and soft hammer, remove input/output shaft.

**NOTE:** Care should be taken to prevent damage to threads or allowing shaft to fall to floor.

5. Remove spacer and snap ring from shaft and press off bearing.

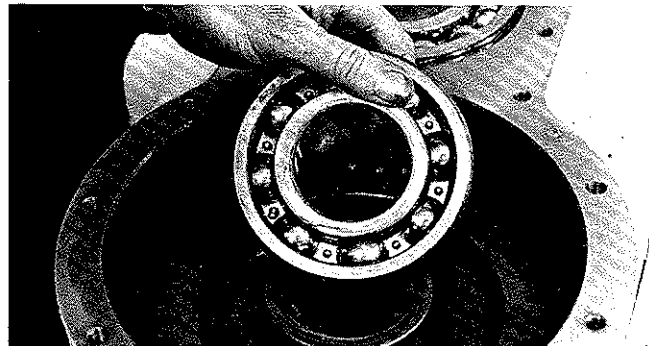

6. Remove bearing from case.

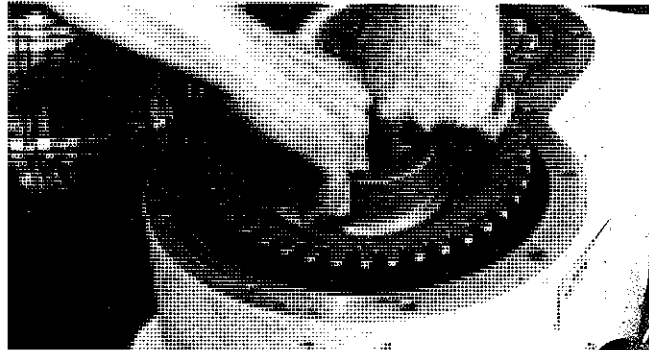

7. Remove input gear from case.

## Intermediate Shaft Disassembly

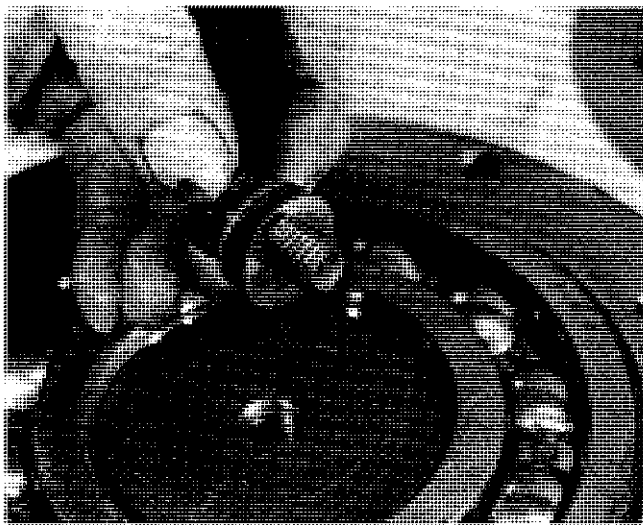
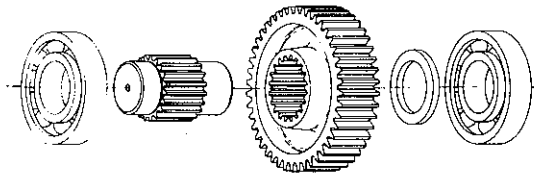

1. Remove pump drive screw and shims if present.

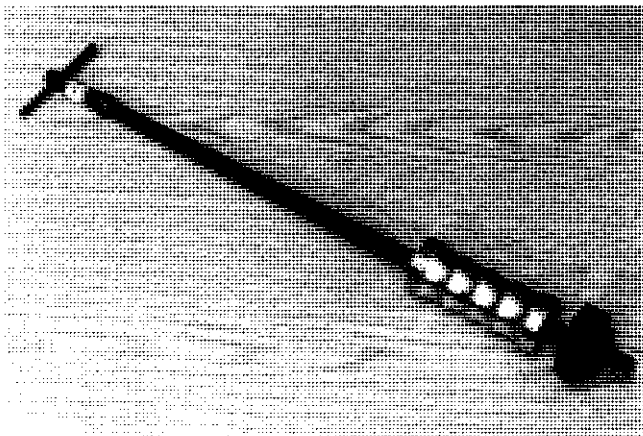

2. Intermediate shaft can be removed with puller-slide hammer as shown above.
3. Screw shaft of puller-slide hammer into tapped hole ( $\frac{1}{2}$ -13 thread) in intermediate shaft, as shown in step #1. Secure with locking nut and remove.
4. Press bearing off intermediate shaft.
5. Remove spacer.

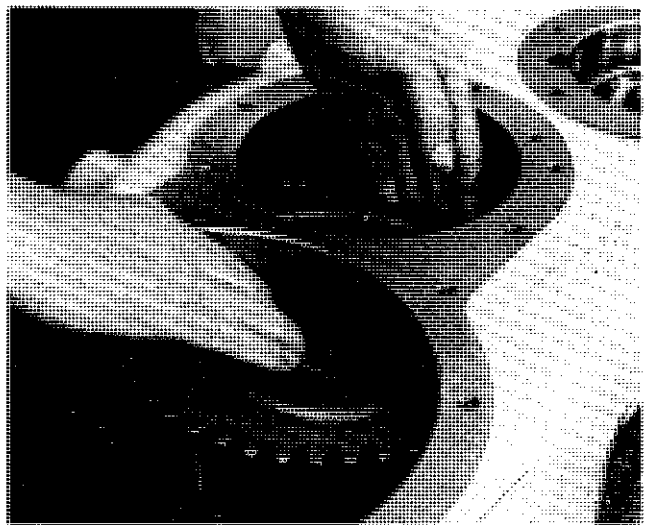

6. Slide intermediate gear to large opening and remove.

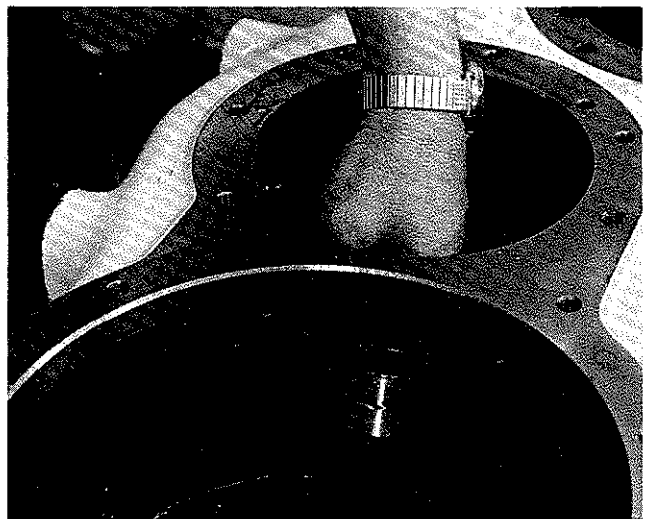

7. Remove bearing from center bore.

# Lower Shaft Disassembly

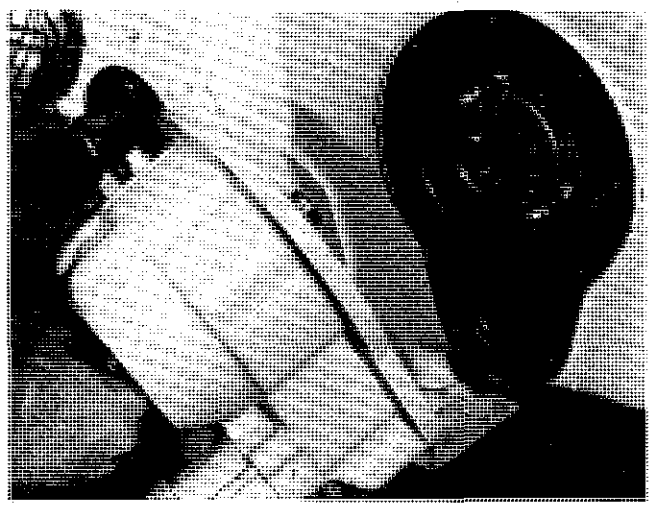
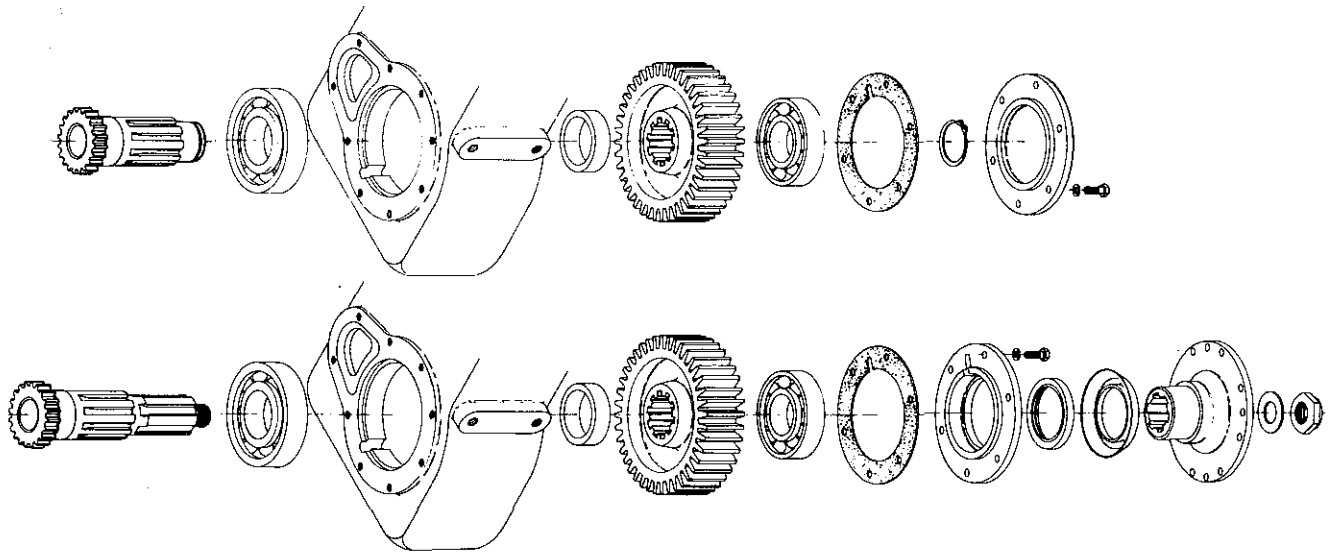

1. Remove shift unit from front of case as described on page 19.

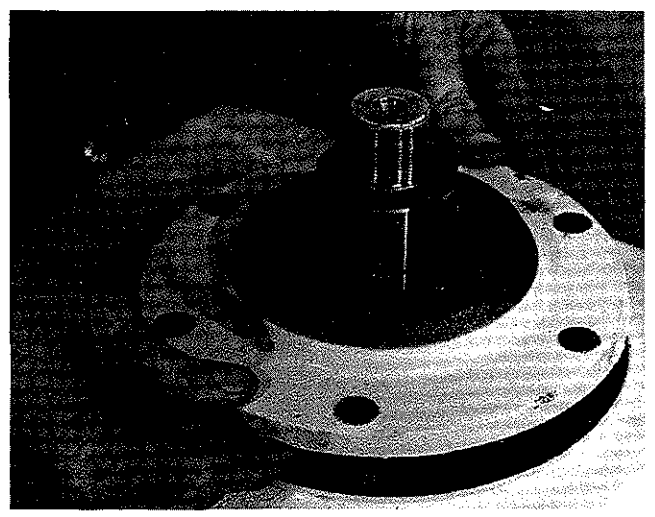

3. Remove six (6) bolts and lockwashers from output bearing cap flange and remove bearing cap and gasket.

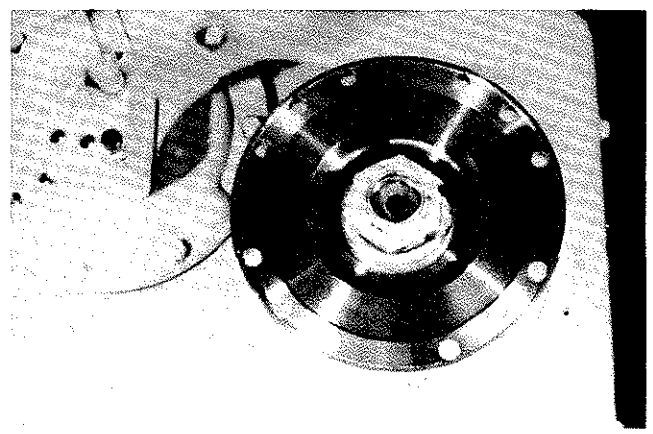

2. Turn unit over and remove locking nut, washer and end yoke or companion flange from rear output shaft.

4. For unit that does not utilize a rear output, remove snap ring.

(CONTINUED NEXT PAGE)





5. Using driver, remove output shaft.

**NOTE:** Care should be taken to prevent damage to threads or allowing shaft to fall to floor.

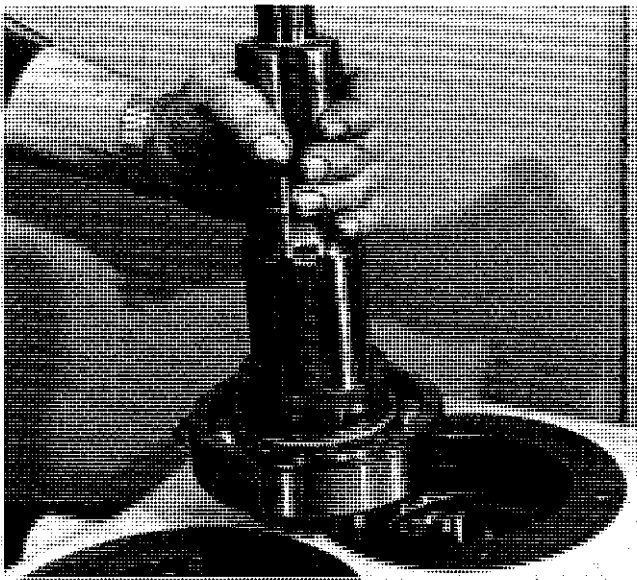

6. Remove spacer and press off bearing.

7. Remove bearing by sliding to large opening.

8. Slide output gear to large opening and remove.

---

# General Precautions for Assembly

---

**IMPORTANT: READ THIS SECTION BEFORE REASSEMBLY**

---

USE ONLY GENUINE REPLACEMENT PARTS FOR SATISFACTORY SERVICE

USE A PRESS WHERE POSSIBLE WHEN ASSEMBLING COMPONENT PARTS.

1. GASKETS: Use new gaskets and seals throughout when reassembling.
2. BOLTS: Make sure all bolts are set to the recommended torques.
3. LUBRICATION: Coat seals, "O" rings, and splines with lubricant. This provides an initial lubrication and helps to prevent damage during assembly. For specifications and fill levels, see page 7.
4. BEARING-FLANGED END: Bearing drivers are recommended for installation of bearings. Equal forces are applied to both races of bearing which maintain correct bearing alignment with bore and shaft. If another type of driver is used, it is important that the force be applied to either the inner race or the outer race without pushing through the balls.
5. YOKES AND FLANGES: Apply grease or lubricant to yoke seal land before pushing through shaft seals. Pull end yoke or companion

flange in place with locknut and torque yoke/flange nut to 400-450 lb.-ft. Failure to draw down tightly can result in axial movement of the shaft and damage to the bearings. Check to make sure that slinger on yoke or flange does not hit transfer case housing.

6. GEARS AND SHAFTS: Check gear teeth surfaces and edges for nicks or burrs which can result in noisy operation. If nicks are found, use a stone to level area around nicks flush with the gear surface. Check shaft splines for burrs which can result in hard shifting or difficult assembly. Stone these likewise.
7. DISCONNECT OPERATION:
  - (A) Air pressure (80-120 psi) is needed to shift the air shift disconnect in and out of engagement. Check disconnect operation after installing the air lines and cab control.
  - (B) While installing linkage or cable to the manual shift clevis, care should be taken not to loosen the clevis from the shifter shaft.
  - (C) both the manual and air shift disconnect have an indicator light switch provision which when connected to the battery and a light in the cab will illuminate the light when disconnect is engaged.

**SAFETY GLASSES SHOULD BE WORN AT ALL TIMES WHEN ASSEMBLING OR DISASSEMBLING**

## Lower Shaft Assembly

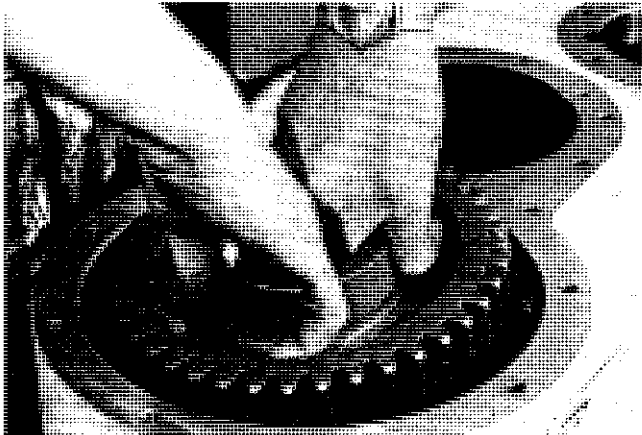
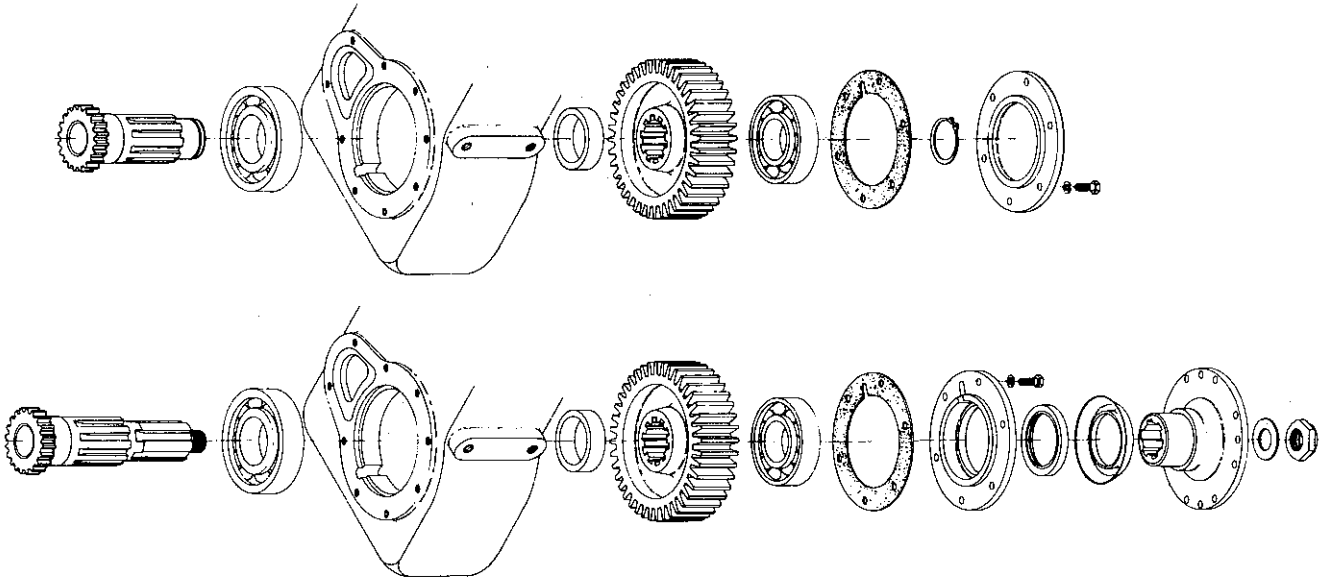

1. Place lower output gear into housing **HUB UP** and slide into position.

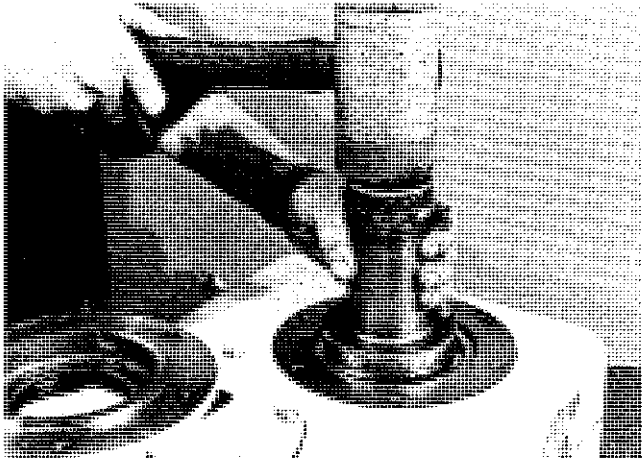

2. Using driver and soft hammer, install bearing into small bore of housing. Recess approximately  $\frac{1}{4}$  inch.

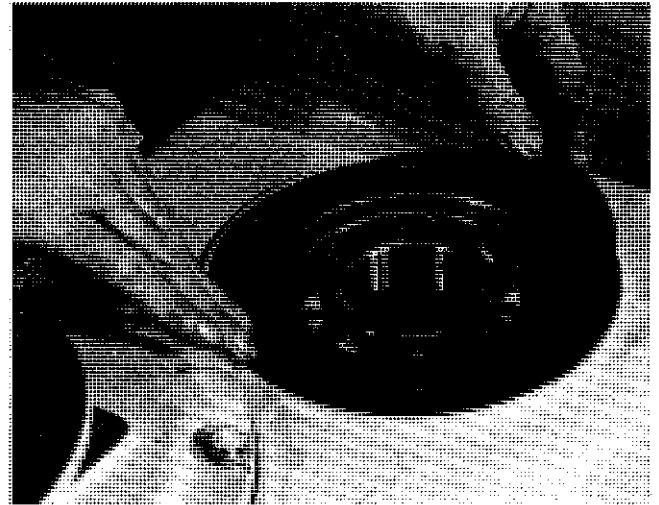

3. Position gasket onto housing, aligning bolt holes and oil groove.

**NOTE:** If shaft that requires snap ring is used, disregard steps 4 & 5 until after shaft is installed.

4. Put a light coat of lubricant on seal and install into bearing cap.

(CONTINUED NEXT PAGE)

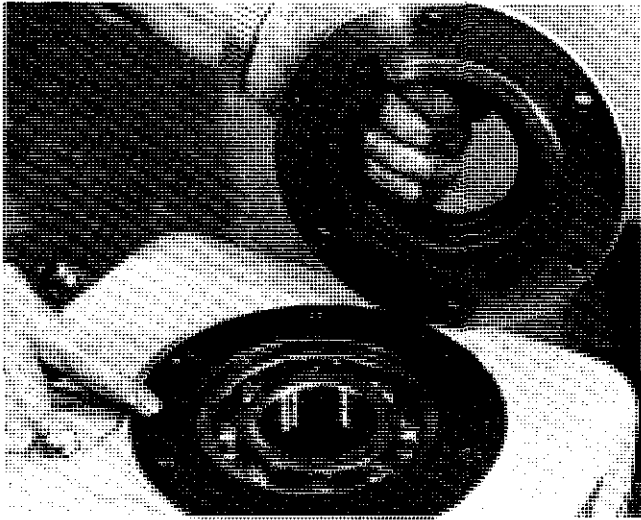

5. Place bearing cap onto housing. Make sure oil groove in bearing cap is aligned with oil groove in housing.

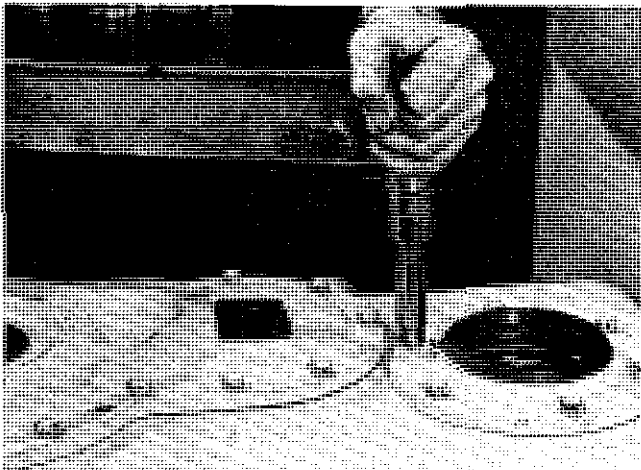

6. Secure with six (6) bolts and lockwashers. Torque bolts to 32-37 ft. lbs.

7. Turn assembly over.

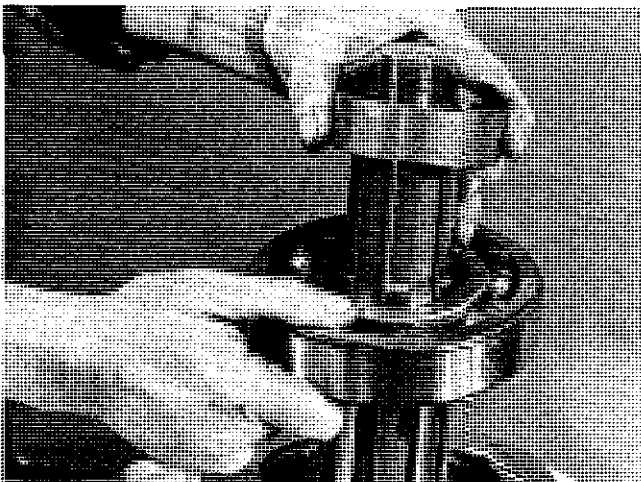

8. Press bearing onto shaft. Install spacer onto shaft.

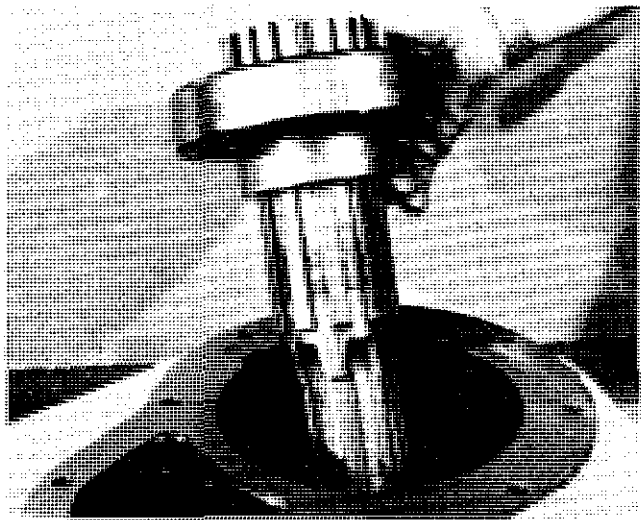

9. Holding the spacer and bearing, turn shaft over and install in gear.

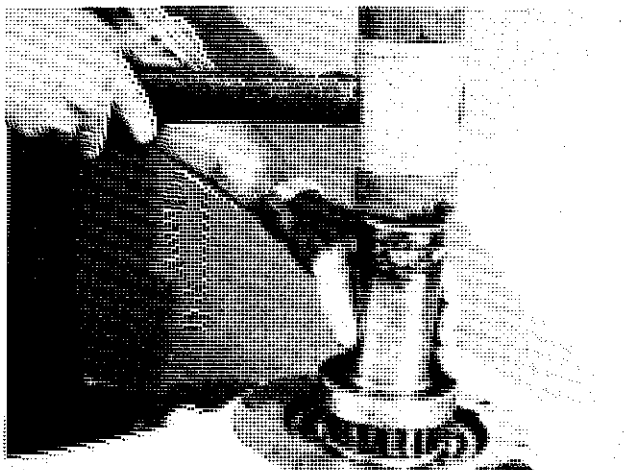

10. Using driver and soft hammer, install shaft.

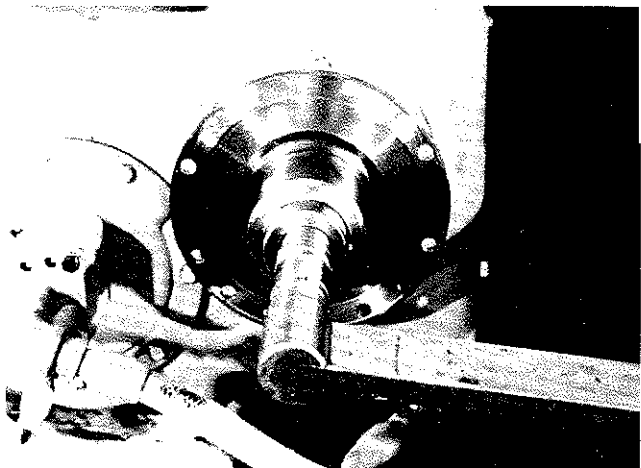

11. Install end yoke or companion flange. Secure with washer and new self-locking nut. Torque nut to 430 ft. lbs.

## Upper Shaft Assembly without Shift Unit

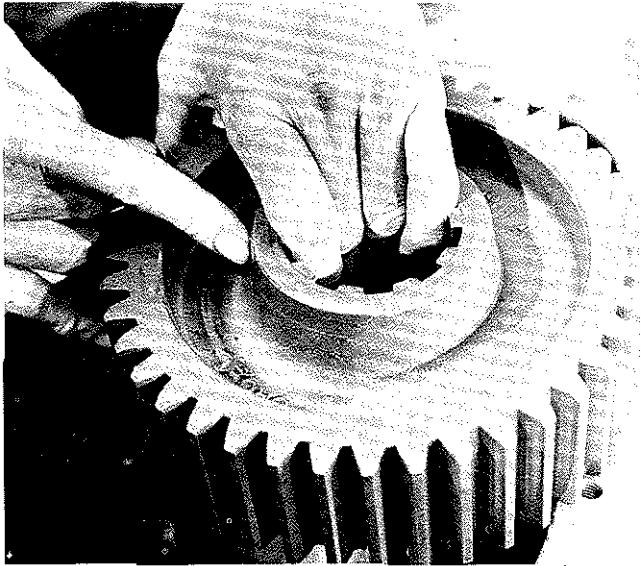
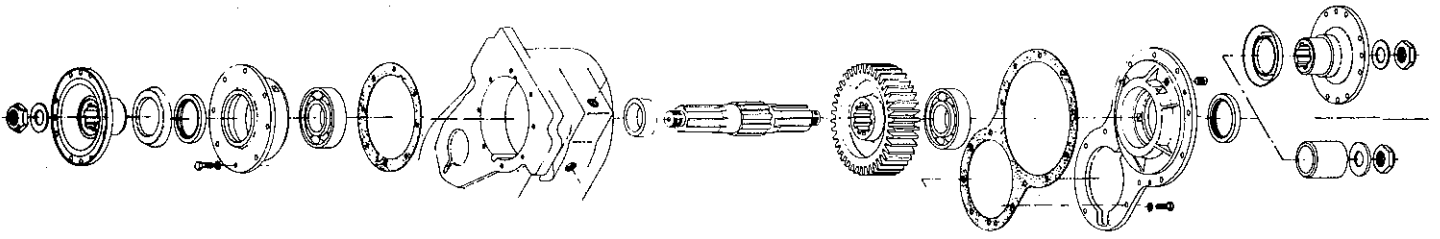

1. Place input gear into housing HUB UP.

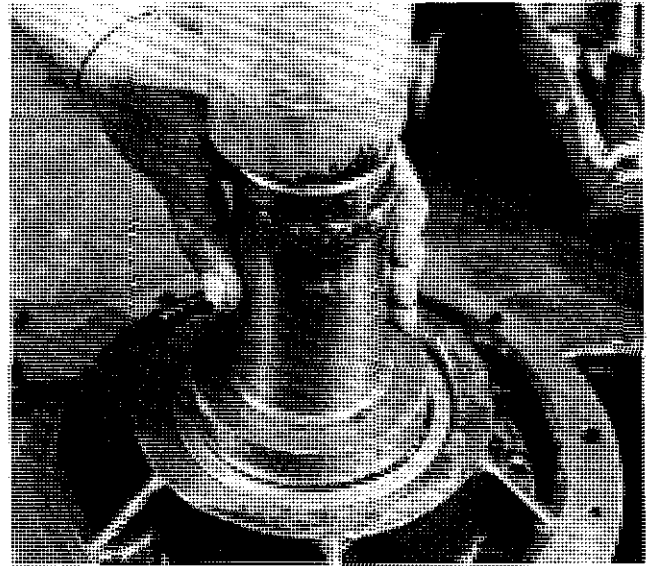

3. Turn input bearing cap over and install bearing.

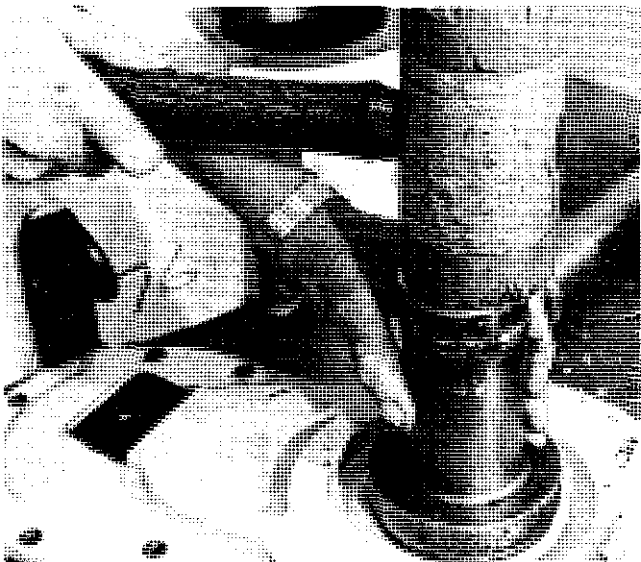

2. Put a light coat of lubricant on input seal lip and install seal into bearing cap.

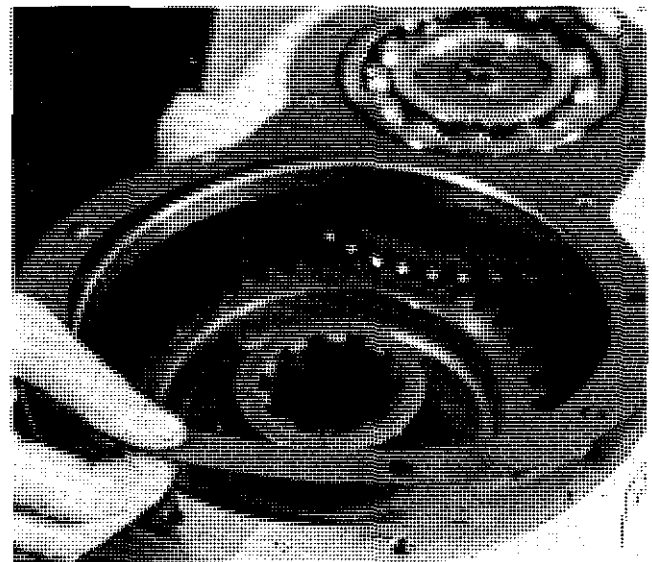

4. Position new gasket on housing, aligning bolt holes.



5. Assemble bearing cap to housing. Secure in place with twelve (12) bolts and lockwashers. Torque bolts to 35-40 ft. lbs.

**NOTE:** For convenience, the lower shaft bearing and bearing cap can be installed at this time. Refer to section on LOWER SHAFT ASSEMBLY.

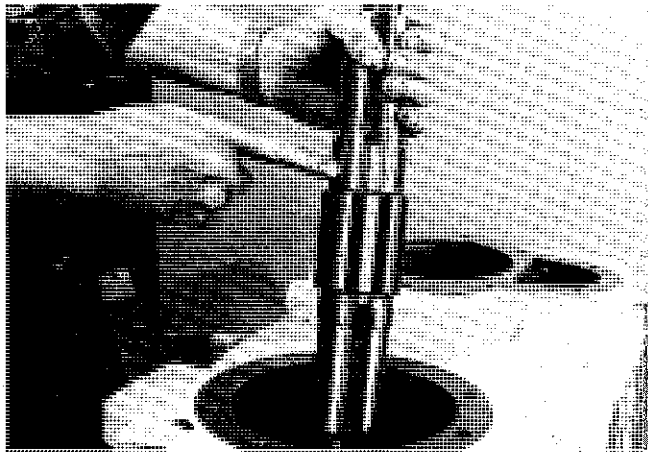

6. Turn assembly over. Install upper input/output shaft **LONG SIDE UP**. Push shaft through gear until it bottoms out.

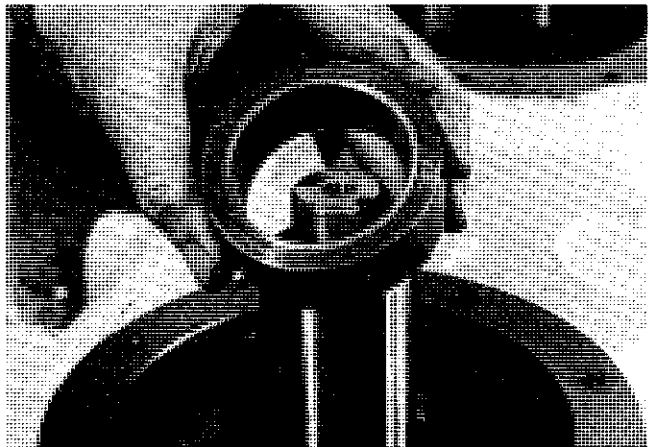

7. Install spacer onto shaft.

8. Put a light coat of lubricant on seal and install into bearing cap.

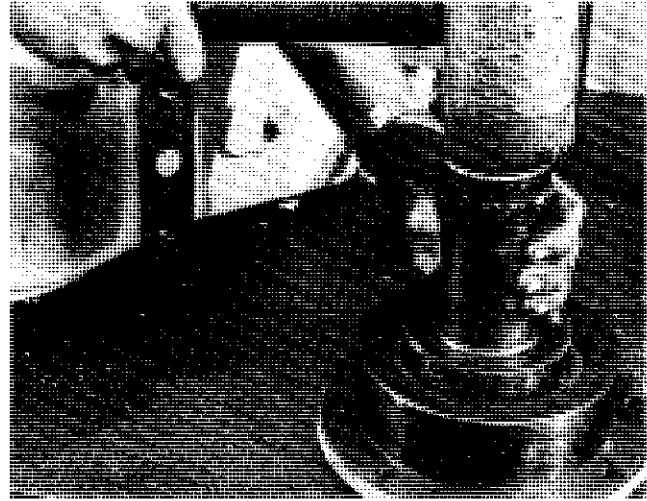

9. Turn bearing cap over and press in bearing.

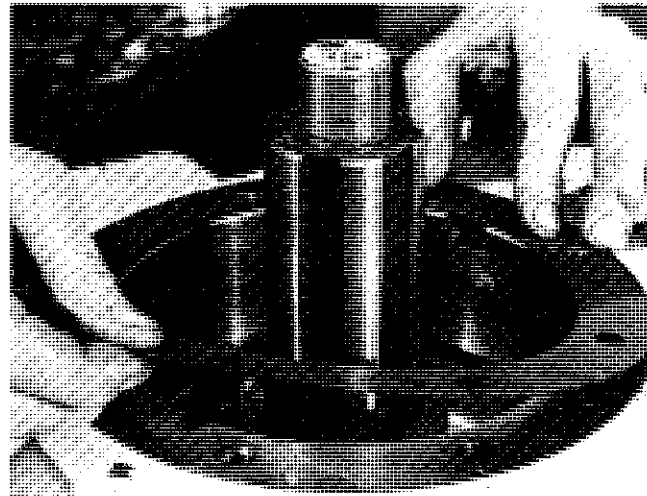

10. Position new gasket on housing, aligning bolt holes and oil groove.

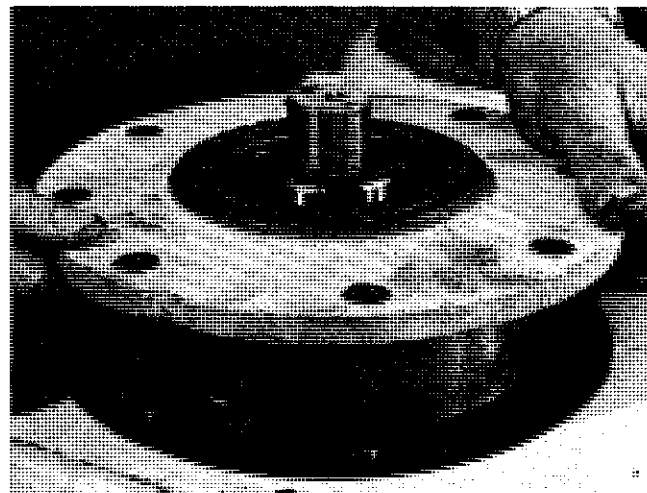

11. Place bearing cap on shaft. Align bolt holes and Oil GROOVE. Using soft hammer, tap bearing cap into position.

12. Secure with eight (8) bolts and lockwashers.

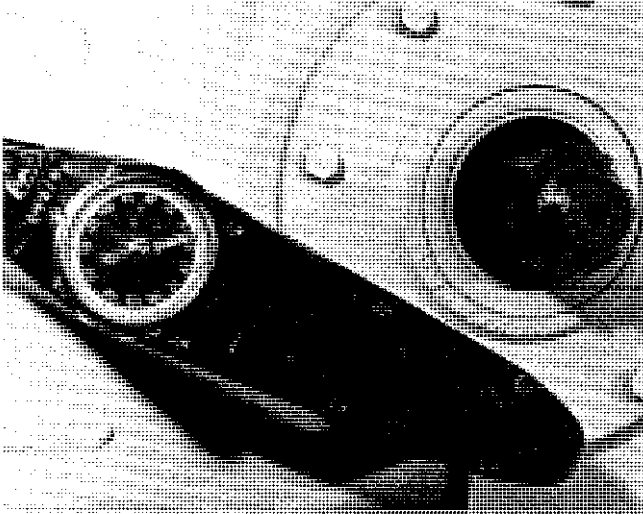

13. Torque bolts to 32-37 ft. lbs.

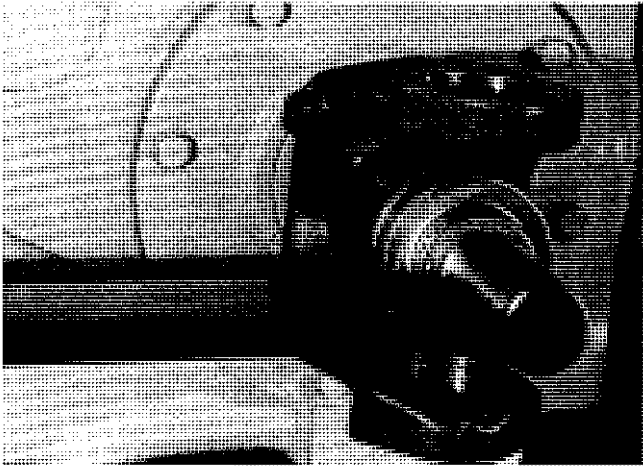

14. Install end yoke or companion flange or spacer on shaft. Secure with washer and new self-locking nut. Torque to 430 ft. lbs.

## Upper Shaft Assembly with Shift Unit

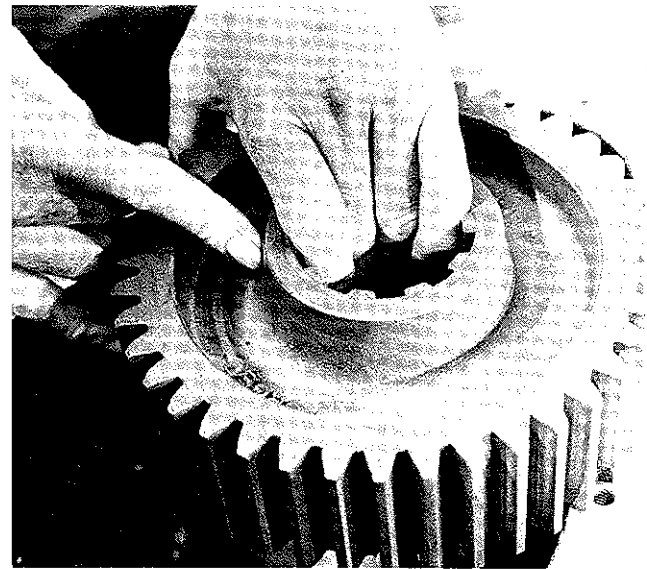
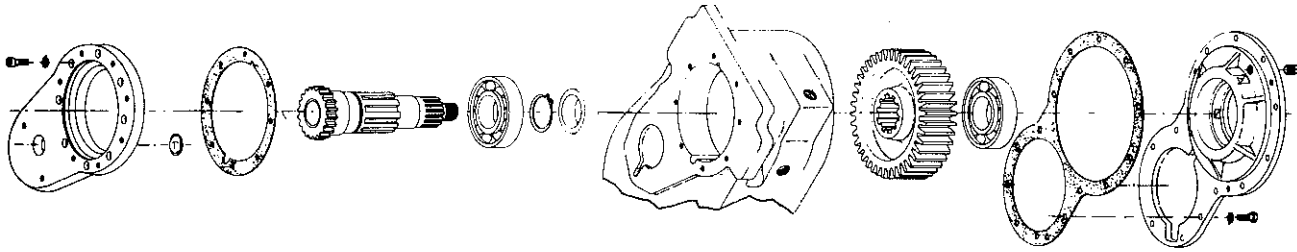

1. Place input gear into housing HUB UP.

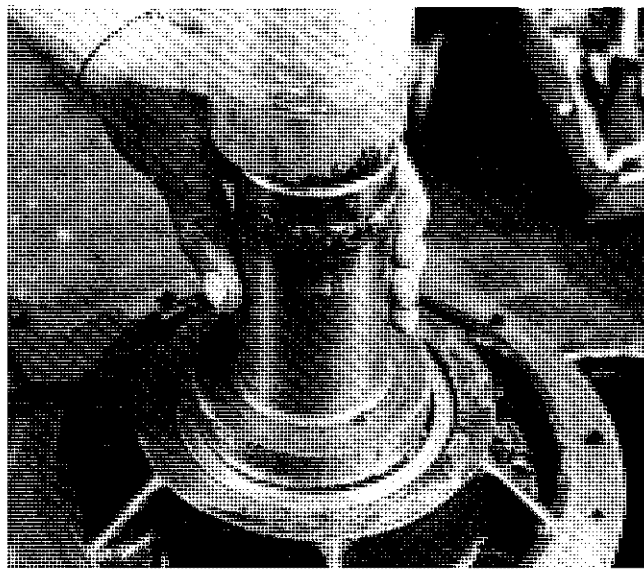

3. Turn input bearing cap over and press in bearing.

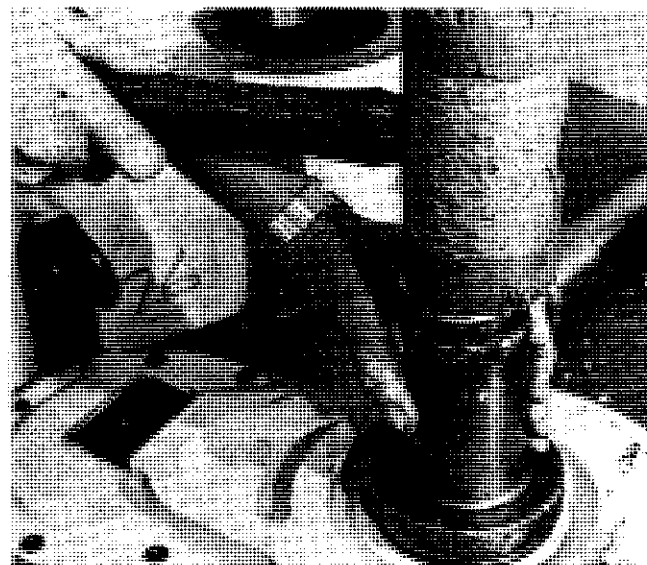

2. Put a light coat of lubrication on input seal lip and install into bearing cap.

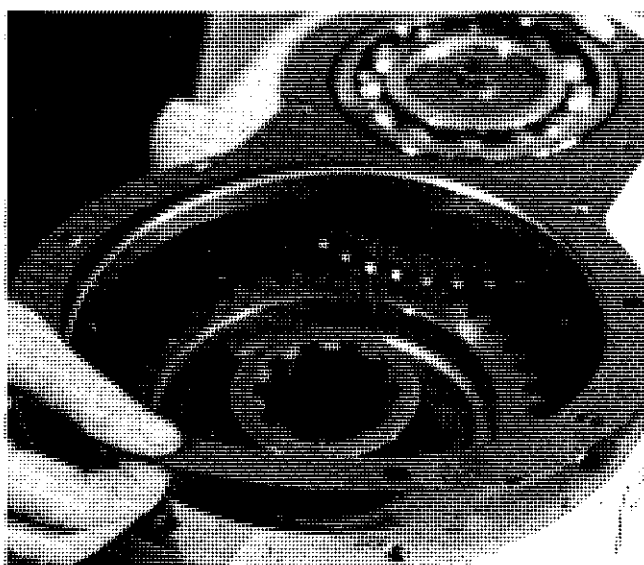

4. Position new gasket on housing, aligning bolt holes.



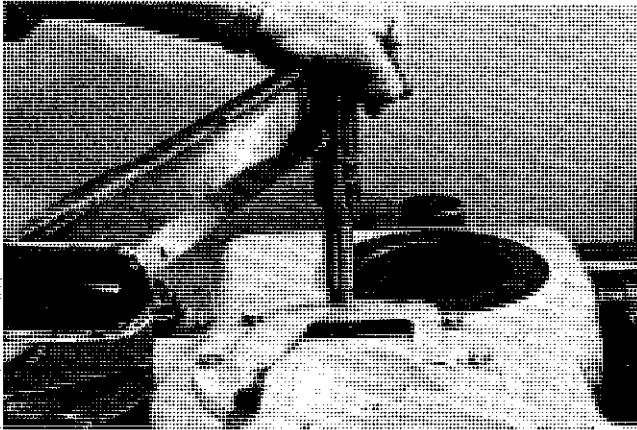

5. Assemble bearing cap to housing. Secure in place with twelve (12) bolts and lockwashers. Torque bolts to 34-40 ft. lbs.

**NOTE: For convenience, the lower shaft bearing and abearing cap can be installed at this time. Refer to section on LOWER SHAFT ASSEMBLY.**

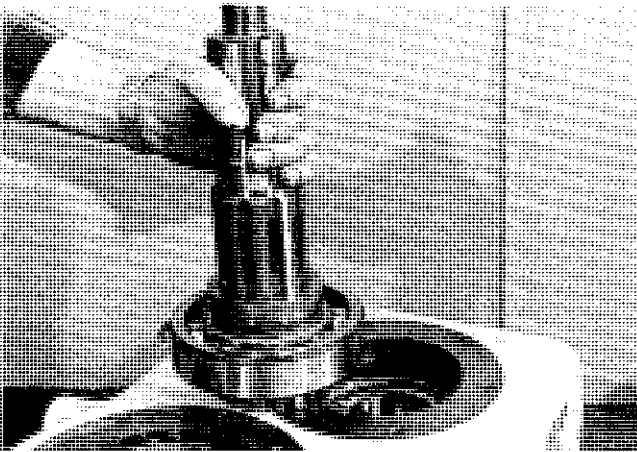

6. Press new bearing onto upper input shaft, and install snap ring into groove. Position spacer onto input shaft next to bearing, as shown.

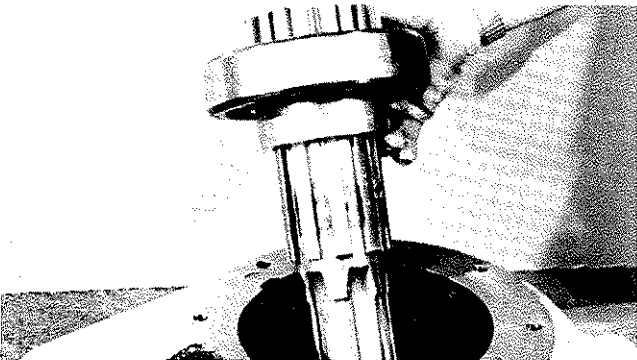

7. Turn transfer case over and start input shaft splines into input gear. Be certain input gear is aligned with opposite bearing, so damage to threads and shaft does not occur. Using a soft hammer, tap shaft through input gear until it bottoms out.

8. Position new gasket onto the housing and install adapter plate. Secure with eight (8) socket head bolts and lockwashers. Torque bolts to 35-40 ft. lbs.

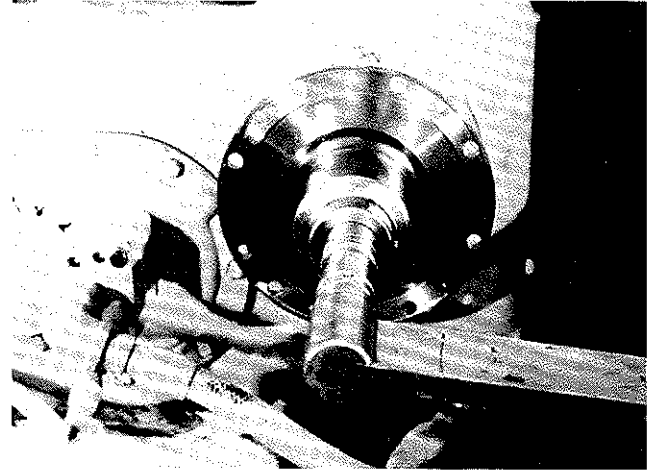

9. Install end yoke, companion flange or spacer onto the shaft. Secure with washer and new self locking nut and torque to 430 ft. lbs. Lubricate roller bearing and install in the end of input shaft. Shift unit can now be installed. Follow procedure outlined in steps 23 and 24 on page 46.

# Assembly of Air Engaged— Spring Disengaged Shift Unit Early Design

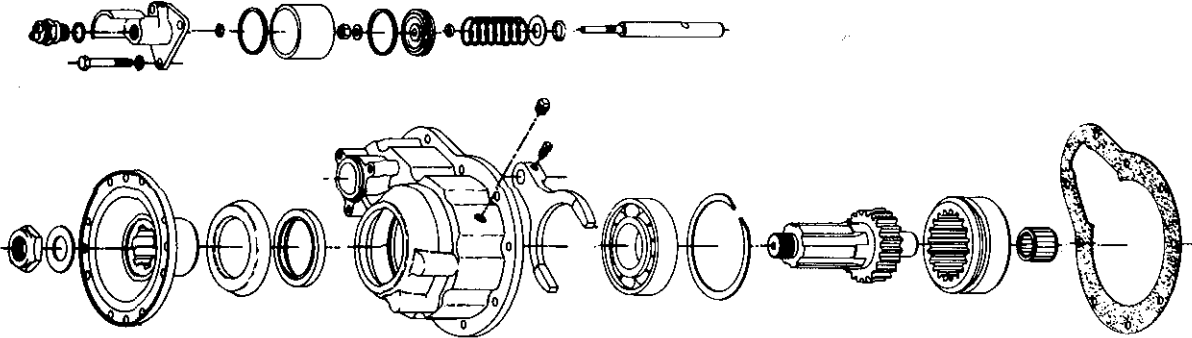

**NOTE:** Steps 1 thru 7 are similar for both manual and air shift units. Add poppet ball, spring, and plug after shift fork shaft has been installed on manual shift units.

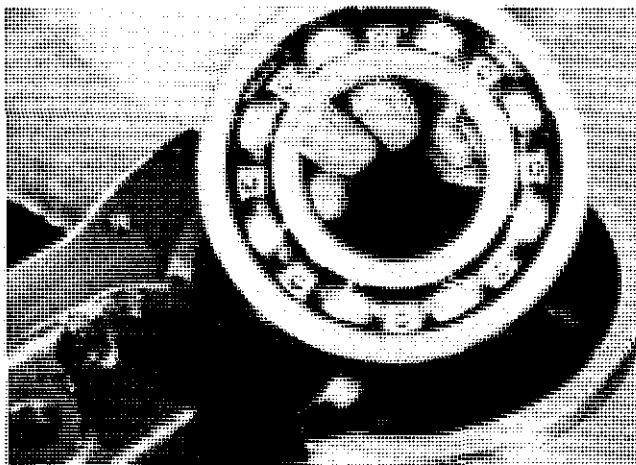

1. Press bearing into shift unit housing.

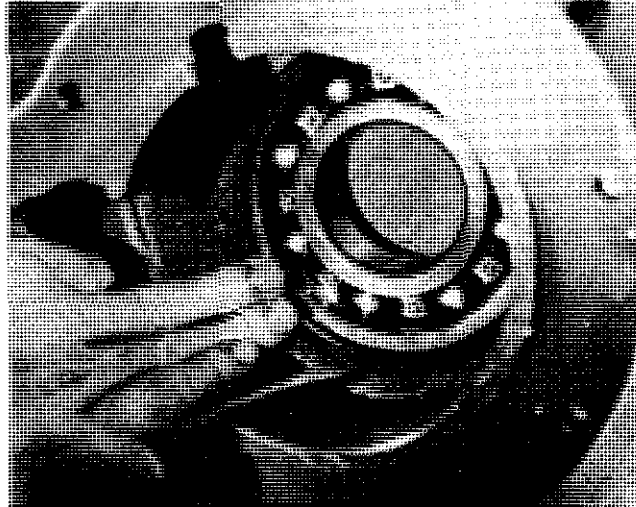

2. Insert snap ring. Make sure snap ring is completely seated into groove.

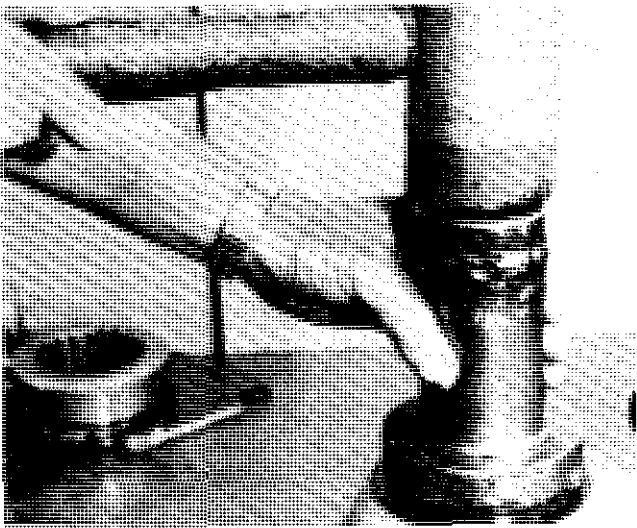

3. Turn housing over. Put a light coat of lubricant on seal lip and install seal into housing.

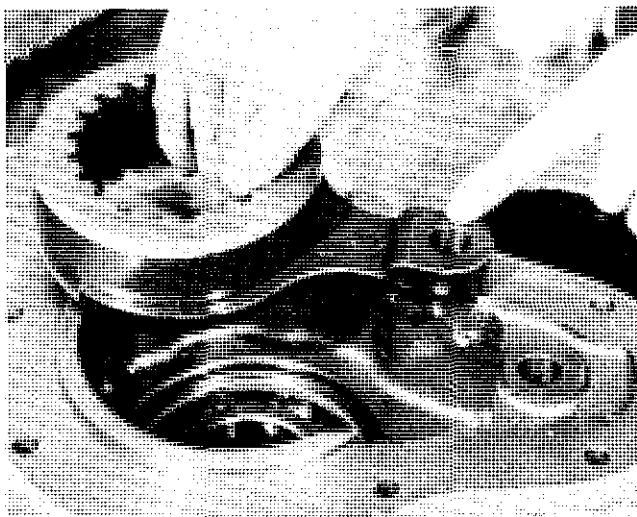

4. Assemble shift fork onto clutch collar. Make sure collar turns freely on shift fork.

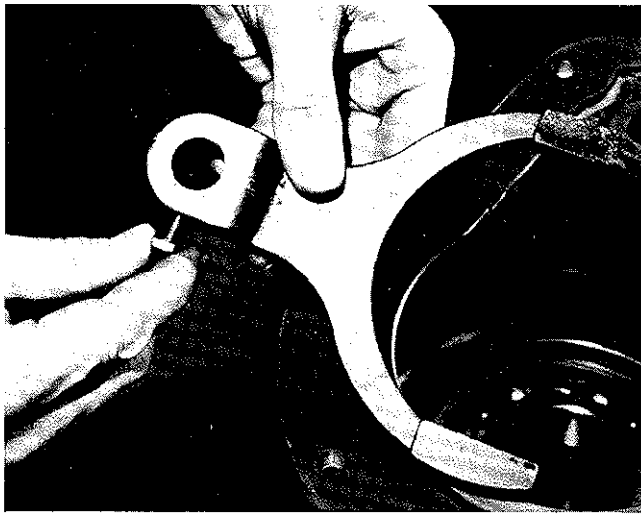

5. Install setscrew into shift fork. Screw in until setscrew is flush with shift fork hole.

6. Install shift fork and clutch into housing.

**NOTE:** The shift fork hub and long side of the clutch collar should be pointing up as shown on step 4.



7. Install shift fork shaft into housing. Align set screw. Torque set screw to 30-40 ft. lbs.

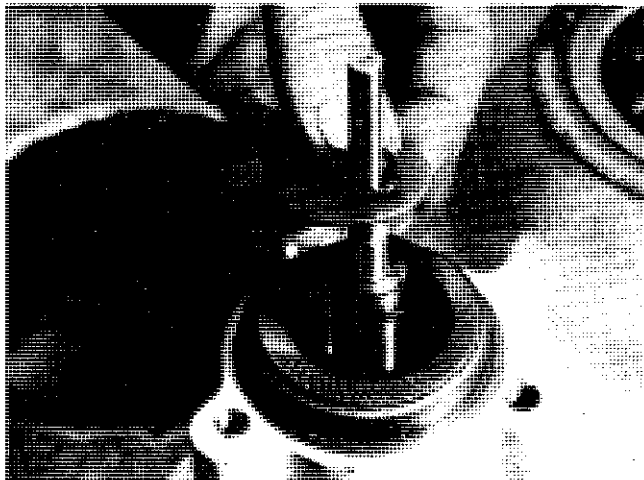

8. Turn housing over. Install the large "O" ring, small "O" ring and washer onto shift fork shaft as shown.

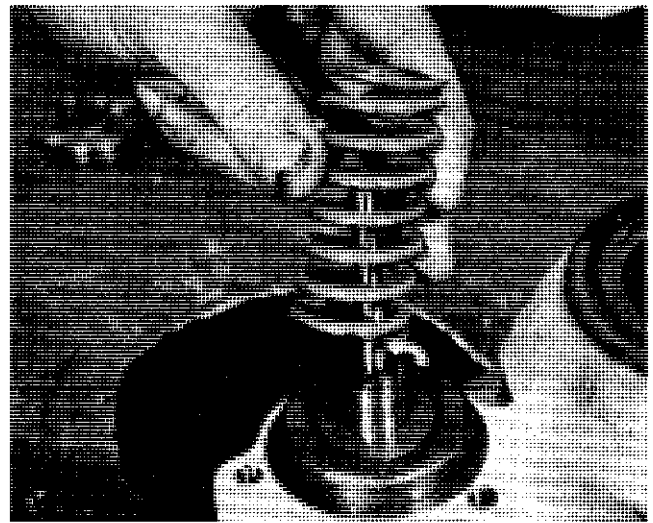

9. Install spring onto shift fork shaft. Push spring to bottom.

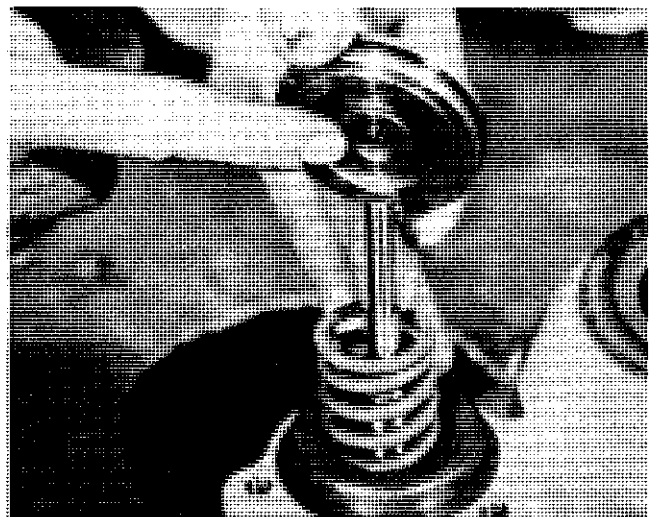

10. Install piston on shift fork shaft COUNTER BORE DOWN.

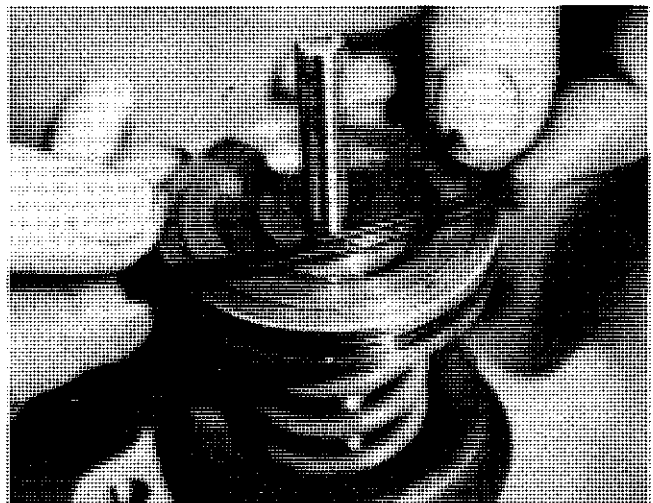

11. Assemble "O" ring onto piston.

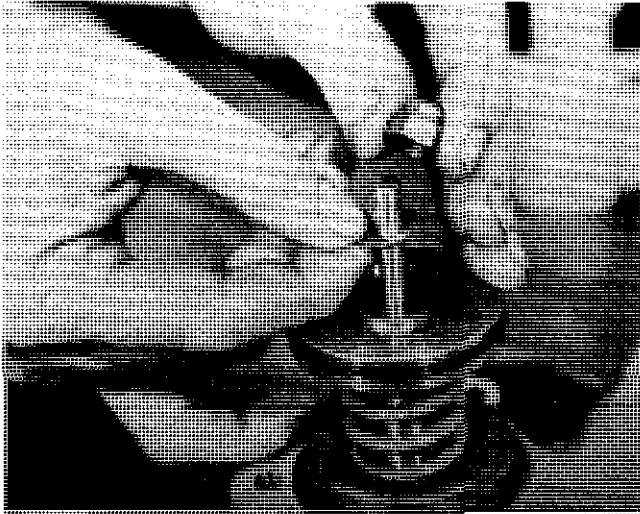

12. Secure in place with washer and locknut. Torque nut to 15-20 ft. lbs.

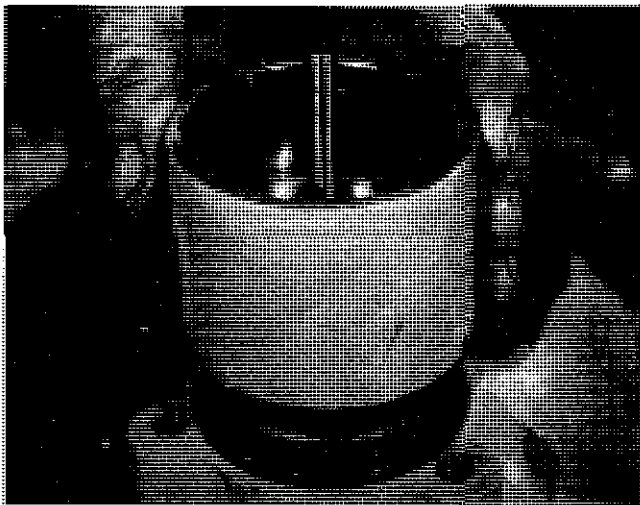

13. Make sure cylinder wall is clean. Put a light coat of lubricant on cylinder wall and place over piston and push to bottom.

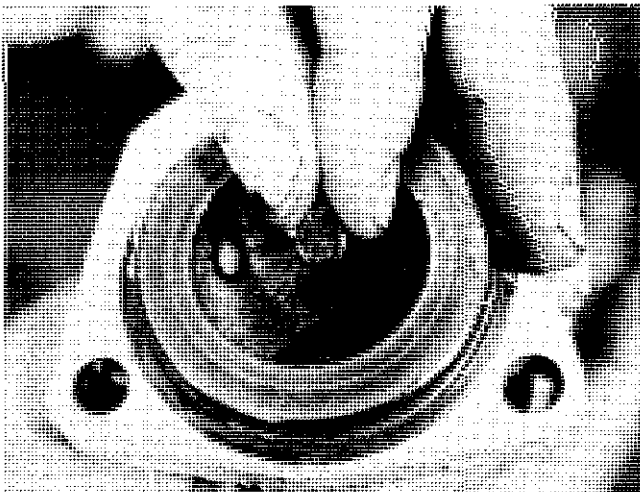

14. Install "O" ring in cylinder cover shift fork shaft hole.

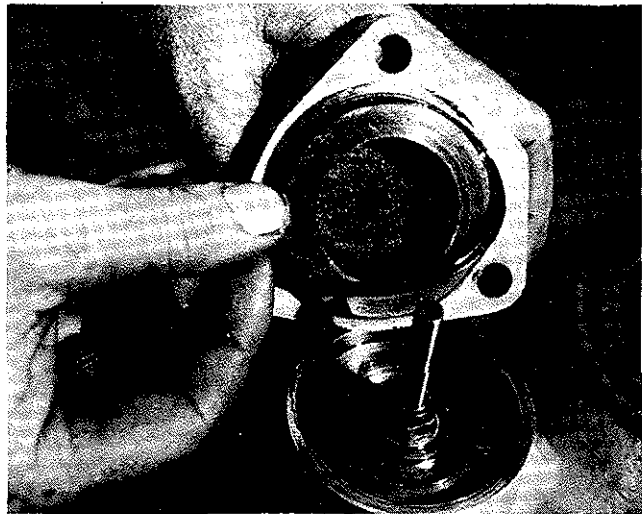

15. Assemble "O" ring onto cylinder cover.



16. Place cover on shift fork shaft and insert into cylinder. Secure in place with three (3) washers and (3) bolts. Torque to 25-30 ft. lbs.

17. Install gasket and indicator switch assembly. Torque to 35-40 ft. lbs.

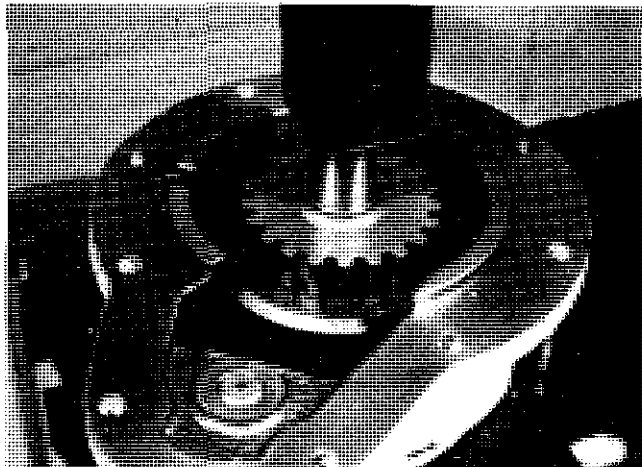

18. Turn disconnect assembly over and install disconnect shaft. Make sure shaft turns freely.

19. Install drain plug.

20. Unit is ready for installation onto transfer case.

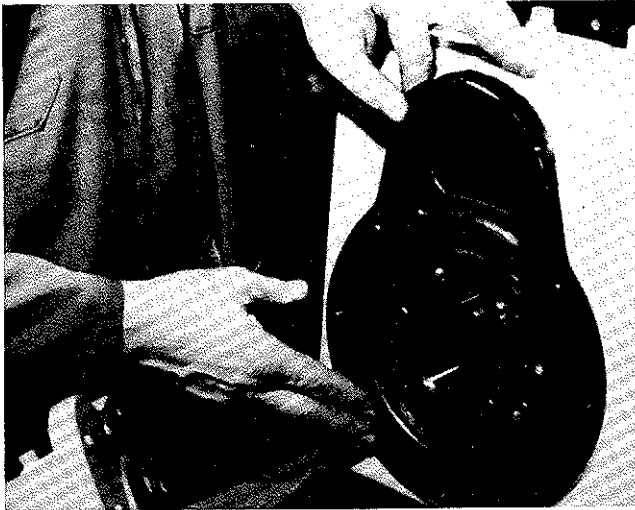

21. Position gasket onto housing, aligning bolt holes and oil groove.

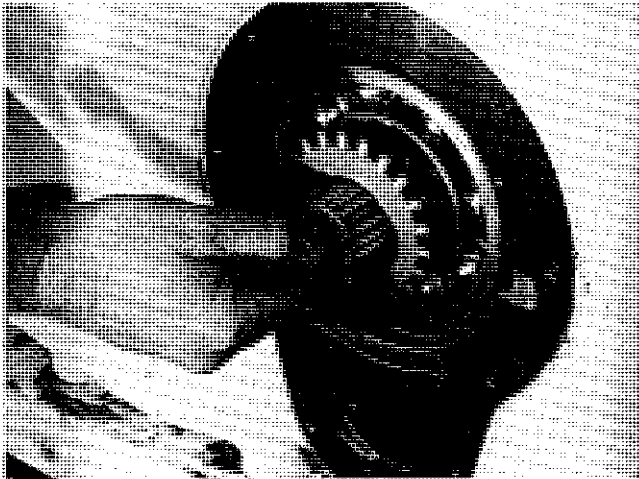

22. Install needle roller bearing in shaft.



23. Position shift unit on housing and secure in place with nine (9) bolts and (9) lockwashers.

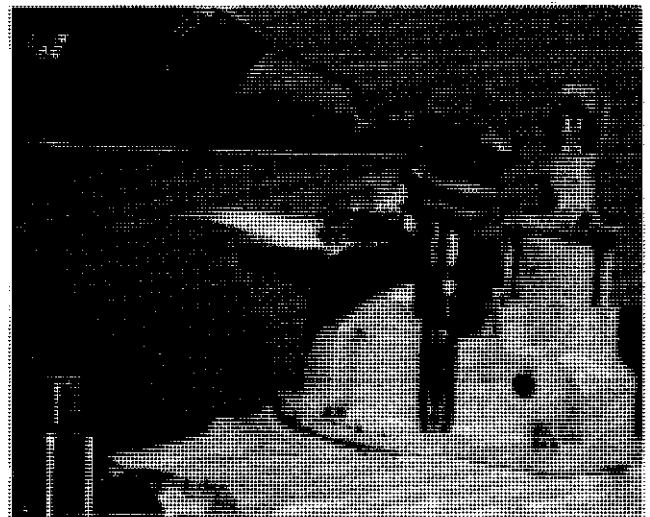

24. Torque bolts to 35-40 ft. lbs.

# Assembly Of Air Engaged — Air Disengaged Disconnect And Manual Shift Late Design

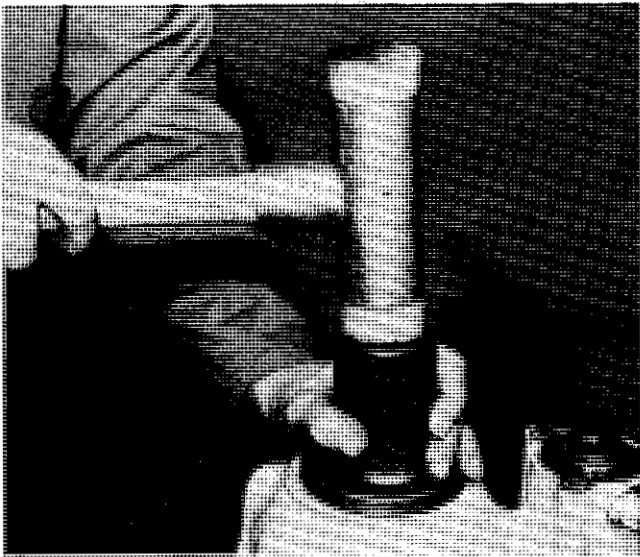
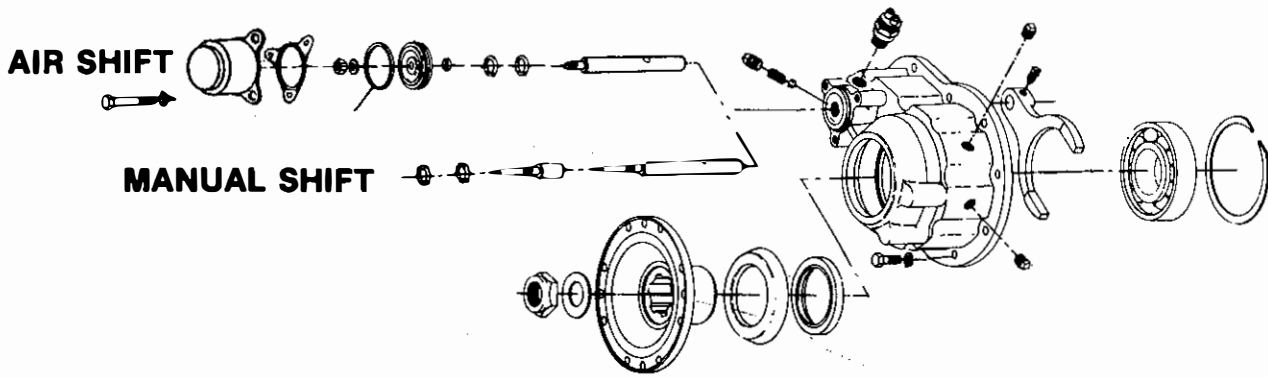

1. Put a light coat of lubricant on the output seal lip and use driver and soft hammer to install seal.

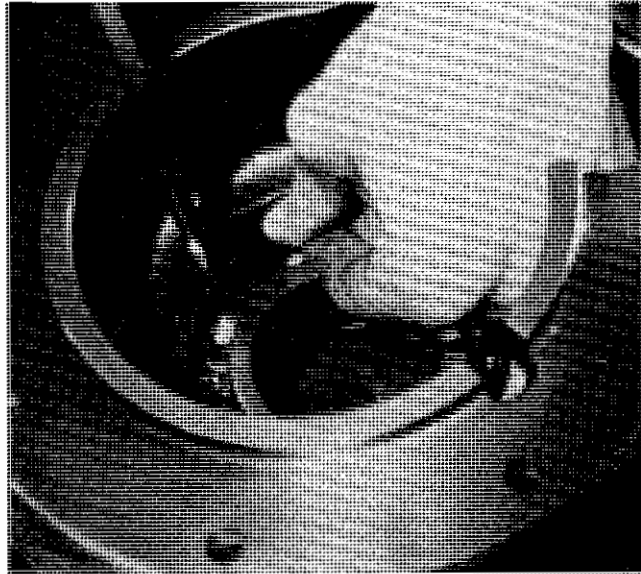

3. Use a common blade screwdriver to install bearing retainer snap ring.



2. Turn disconnect housing over. Use a driver and soft hammer to install output shaft bearing.

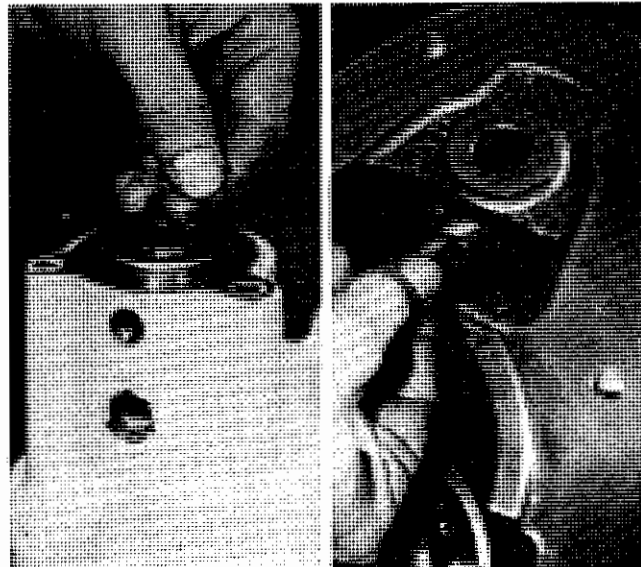

4. Install shift fork shaft "O" Rings into disconnect housing.

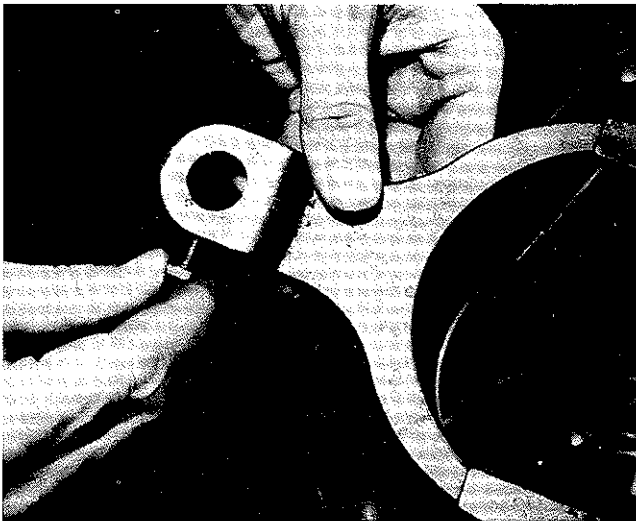

5. Partially install set screw into shift fork.

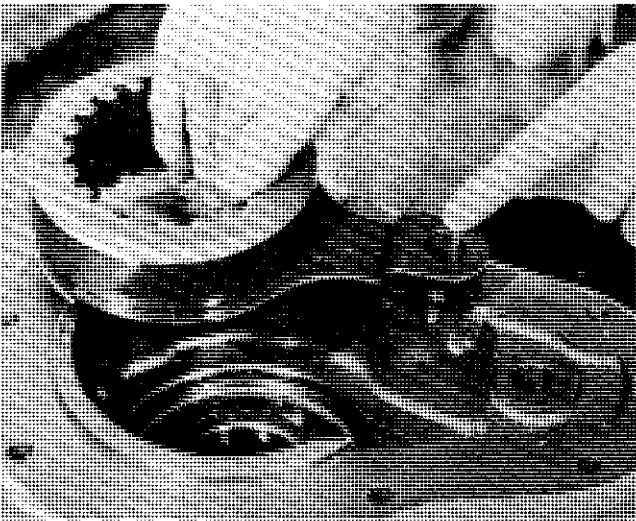

6. Place clutch collar onto shift fork, long side up and install into disconnect housing. Be sure boss on shift fork is facing up.

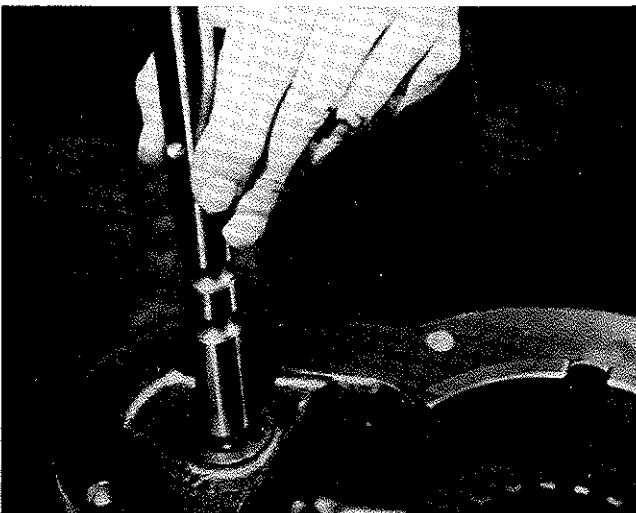

7. Install shift fork shaft into housing shaft. Align pilot with set screw

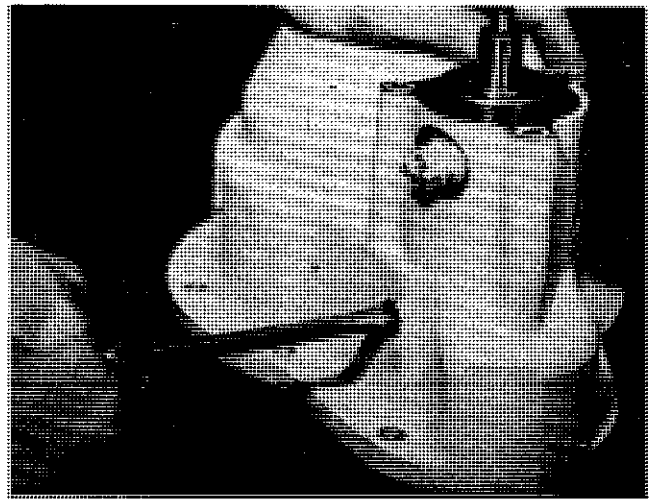

8. Tighten set screw and install and tighten square head plug.

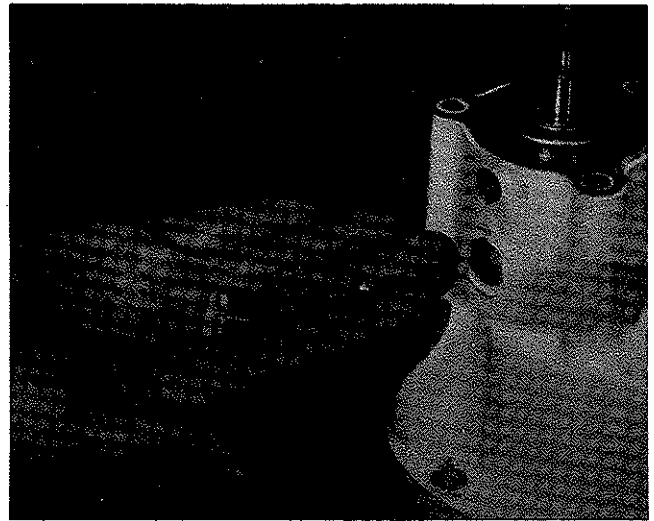

9. Align groove on shift fork shaft with poppet. Install poppet ball, spring and hex head plug.

10. Install indicator switch torque switch to 40-50 ft-lbs.

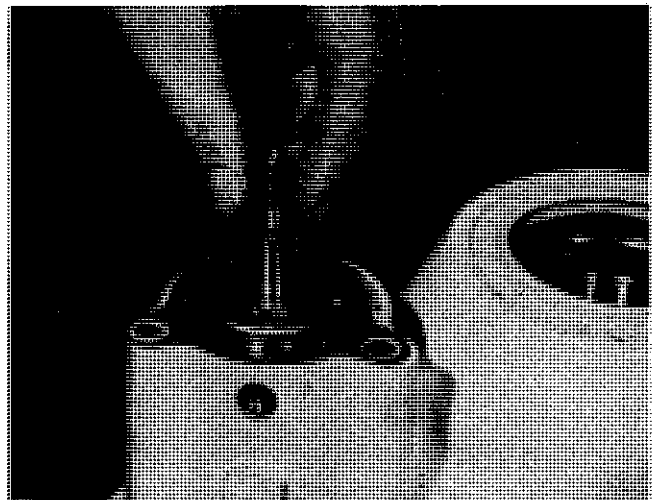

11. Install small "O" Ring onto shift fork shaft.

14. Place brass washer and locknut onto shift fork shaft. Torque nut to 18-25 ft-lbs.

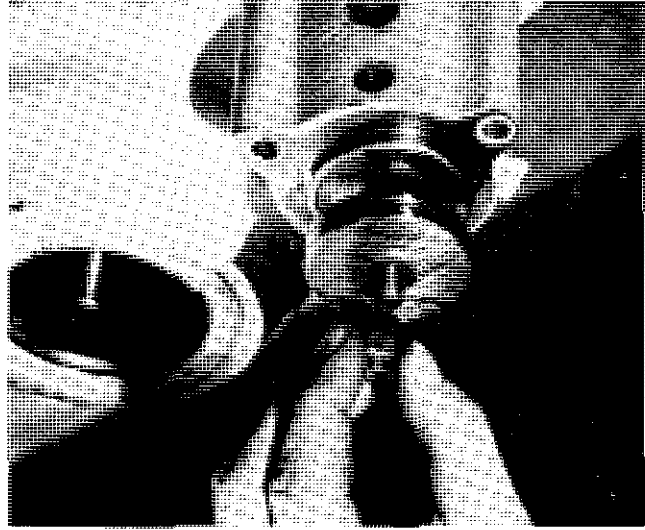

13. Place piston onto shift fork shaft. Be sure counter bore on piston is down or faces small "O" Ring.



12. Assemble new "O" Ring onto piston.

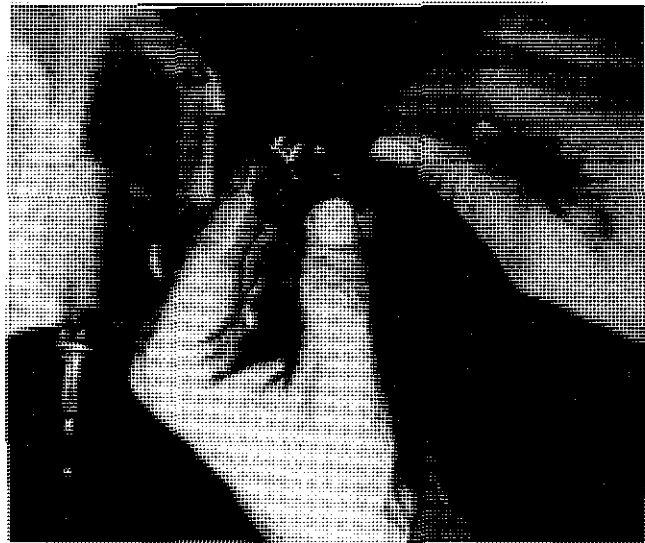

17. Place disconnect assembly onto press and install output shaft.

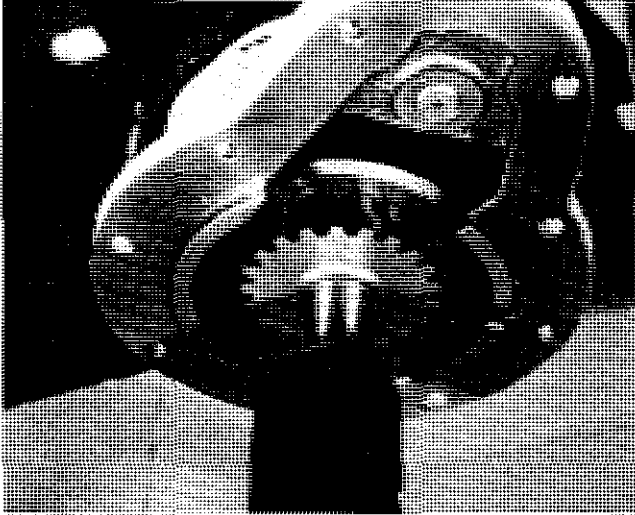

16. Assemble cylinder onto housing, install (3) three hex head bolts and lockwashers. Torque bolts to 25-30 ft. lbs.

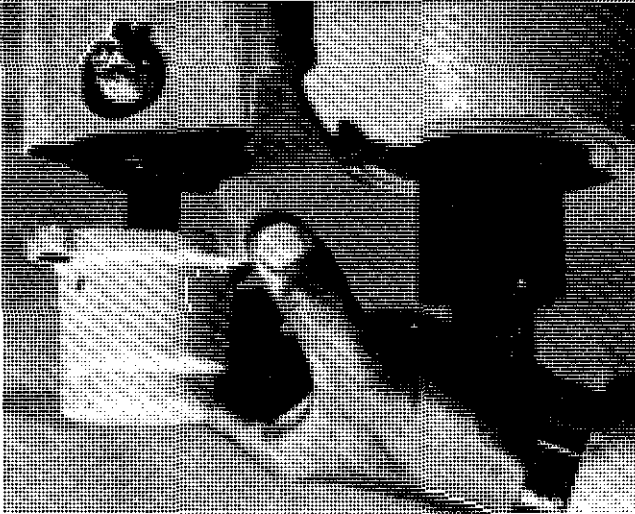

15. Place air cylinder gasket onto disconnect housing.

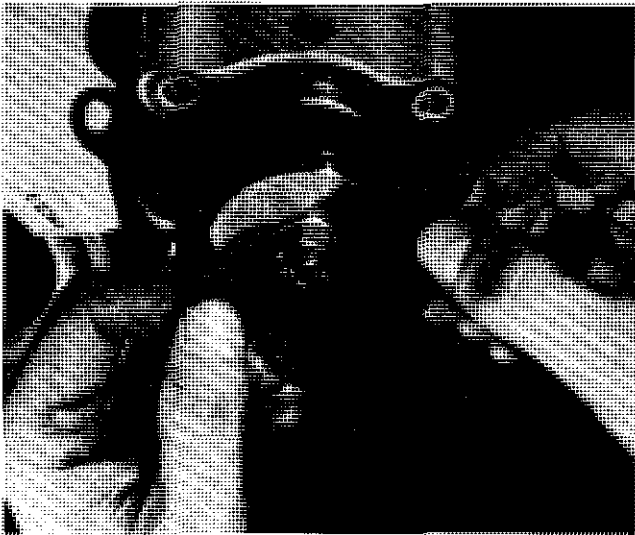





18. Position gasket onto transfer case housing. Be sure to align oil grooves.



19. Install needle roller bearings into output shaft.

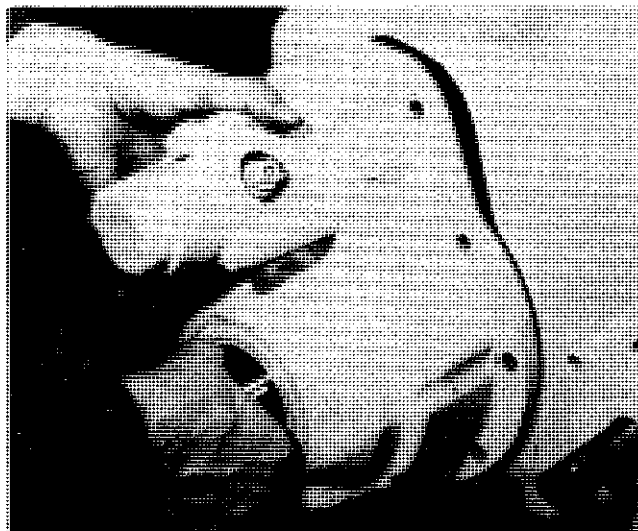

20. Assemble disconnect assembly onto transfer case housing. Install (9) nine hex head bolts and lockwashers. Torque to 35-50 ft-lbs.

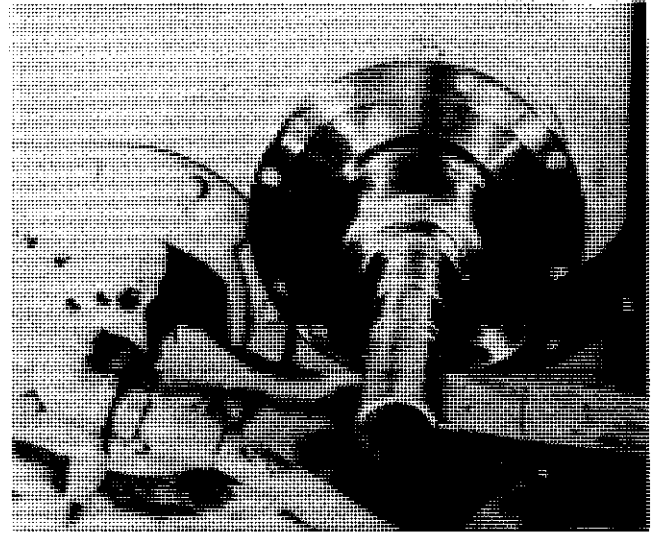

21. Install end yoke or companion flange. Secure with washer and new self-locking nut. Torque to 430 ft. lbs.

# LUBRICATION PUMP

## Assembling onto Transfer Case

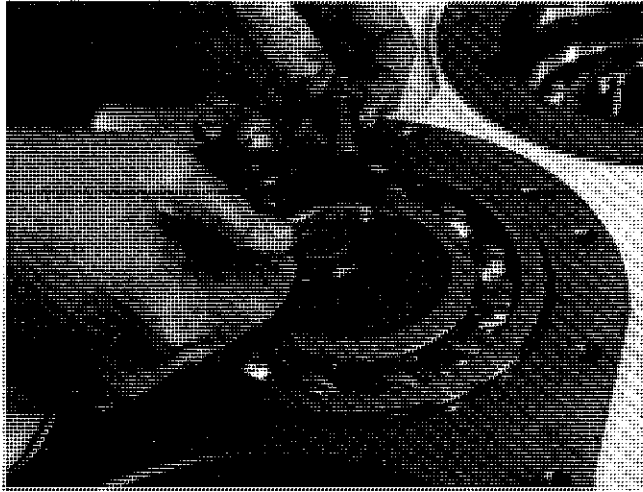

1. Make sure drive screw has been installed into intermediate shaft.

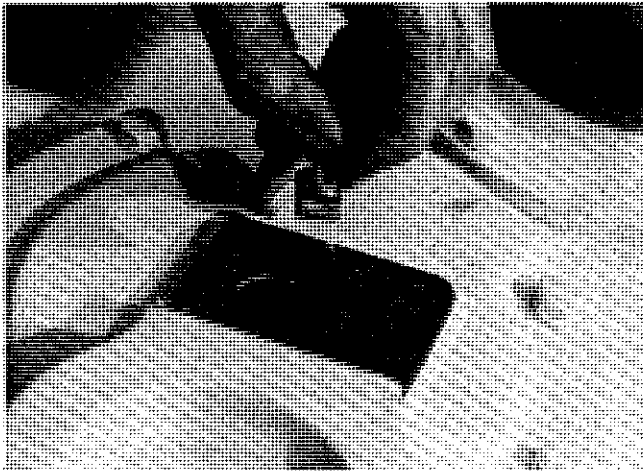

2. Install coupling into drivescrew.



3. Place new gaskets on housing, aligning bolt holes and coupling hole.

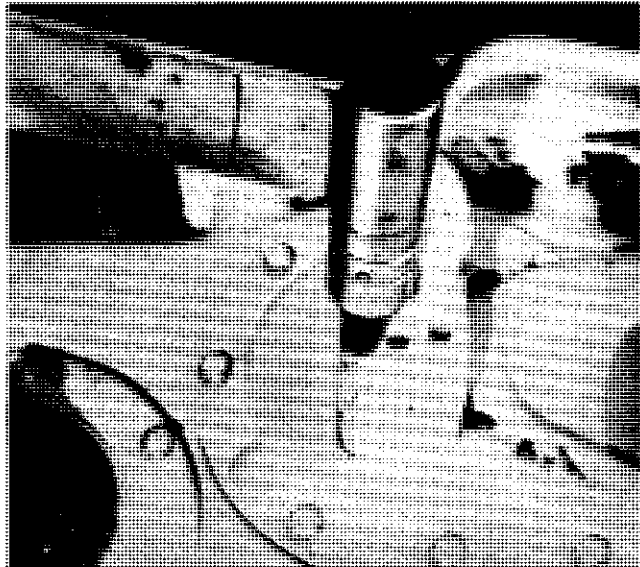

4. Align pump coupling and install lubrication pump on housing. Secure in place with two (2) cap bolts and torque to 14-16 ft. lbs.

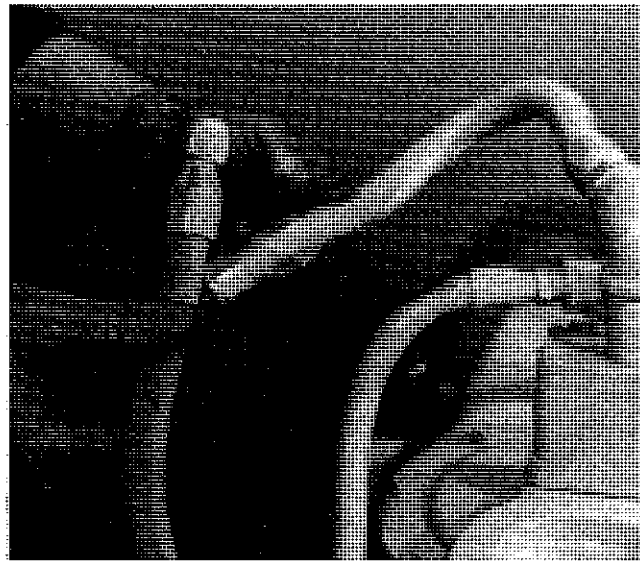

5. Connect hose assemblies.

## IDENTIFICATION OF LUBE PUMP ROTATION

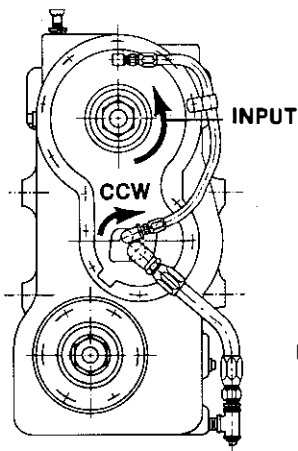

Models 738/738-A  
REAR VIEW

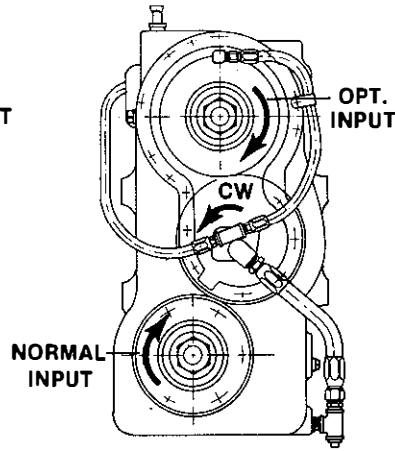

Model 784  
FRONT VIEW

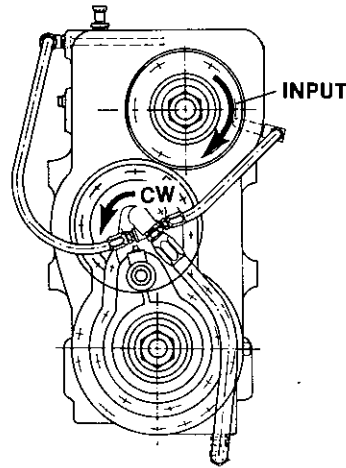

Models 785/791  
FRONT VIEW

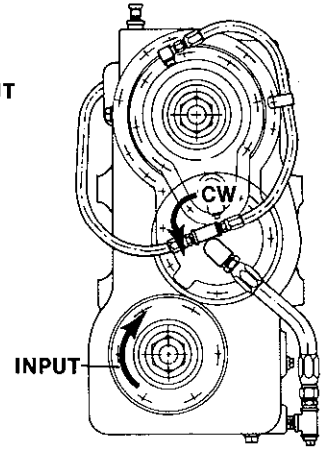

Model 792  
FRONT VIEW

There are two different lube pumps for the 738 family of transfer cases. Part number 378889-1 is clockwise input and 378853-1 is for counter-clockwise input. **This rotation specification is for the lube pump and is not necessarily the input rotation of the transfer case.**

When the transfer case is mounted normally (as shown above) the 738A, B, C, D, & E will need a "G" (CCW) pump and all others will require an "F" (CW) pump. **This rotation is determined by looking in at the lube pump input shaft.** When any of the transfer cases are turned around or upside-down or both, **the rotation of the lube pump specified in the model number is always for the lube pump when looking in at its input shaft.**

The lube pump is optional on the 738A, B, C, D, & E versions. The need for this option arises during prolonged low input R.P.M. to the transfer case. A typical use is a concrete mixer

pouring concrete into a curbing form while creeping along. Splash lubrication is adequate down to 1000 R.P.M. input to the transfer case while the lube pump adaption allows 300 R.P.M. prolonged input. The lube pump is standard on the 784, 785, 791, & 792 since these models function with the vehicle stationary. Stationary cooling is normally adequate to 250 HP with the lube pump.

### LUBE PUMP OPERATION

If the transfer case is equipped with a lube pump, loosen the hydraulic line(s) and run the transfer case momentarily to check for oil flow. Retighten lines after check.

### PREDELIVERY CHECKOUT

Run transfer case through its operating speeds to check for oil leaks, vibrations, noise, heat, etc. This should be done with the vehicle stationary, if possible.