



Fabco TC-140, 141 Transfer Case Service Manual

Pro Gear Fabco TC-140, TC-141 Transfer case Service Manual to assist in identifying your Fabco unit.

If you need any assistance identifying the correct transfer case unit for your truck and equipment, contact your Fabco replacement part specialists at Pro Gear and Transmission.

Pro Gear Transmission has same day shipping and 1000's of products in stock and ready to ship internationally for your next project.

For parts or service contact the Fabco specialists at Pro Gear & Transmission, Inc.

1 (877) 776-4600
(407) 872-1901
parts@eprogear.com



FABCO TC-140, 141 TRANSFER CASE

OPERATION MANUAL

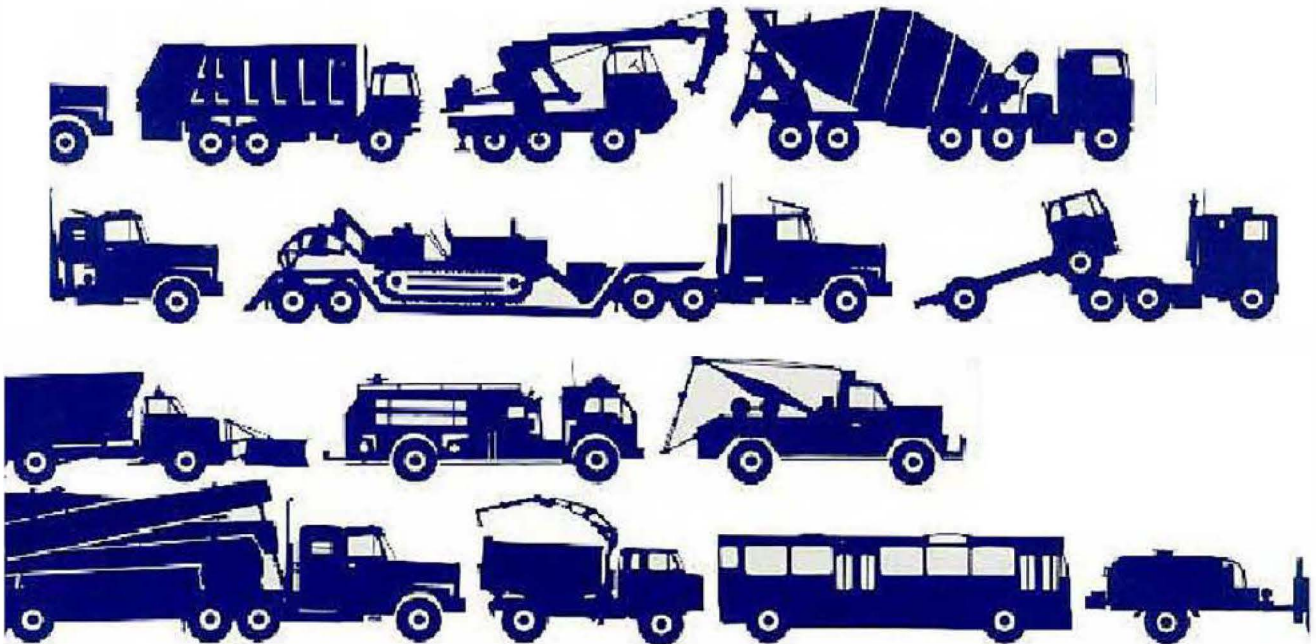

A business unit of **tti**

SERVICE MANUAL TC-140 TRANSFER CASE TWO SPEED, TC-141 SINGLE SPEED

Table of Contents

<p>I. TC-140 Transfer Case</p> <ul style="list-style-type: none"> A. General 1 B. Transfer Case Specifications 2 C. Nomenclature 4 D. Warranty 4 <p>II. Operating Instructions</p> <ul style="list-style-type: none"> A. General 5 B. Front Drive Declutch 5 C. Proportional Differential 5 <p>III. Lubrication</p> <ul style="list-style-type: none"> A. Transfer Case Oil Change 6 B. Draining Oil 6 C. Refilling Oil 7 D. Inspection 7 E. Oil Change and Inspection Recommendations 7 F. Operating Temperature 7 G. Shift Cylinder Inspection 7 <p>IV. Vehicle Transfer Case Removal and Installation</p> <ul style="list-style-type: none"> A. Removal 8 B. Installation 8 <p>V. Transfer Case Disassembly</p> <ul style="list-style-type: none"> A. General precautions for Disassembly 9 B. PTO and Declutch Disassembly 10 C. Lockout Disassembly 11 D. Direct Pump Drive 14 E. Shift Shaft Disassembly 14 F. Upper Shaft Disassembly 16 G. Lower Shaft Disassembly 19 H. Intermediate Shaft Disassembly 34 I. Oil Pump Disassembly 36 	<p>VI. Cleaning and Inspection</p> <ul style="list-style-type: none"> A. Choice of Cleaning Methods 37 B. Drying and Corrosion Inhibition 37 C. Inspection 37 <p>VII. Transfer Case Assembly</p> <ul style="list-style-type: none"> A. General Precautions for Reassembly 38 B. Intermediate Shaft Assembly 38 C. Upper Shaft Assembly 40 D. Lower Shaft Assembly 43 E. Lockout Assembly 63 F. PTO and Declutch Assembly 67 G. Direct Pump Drive Assembly 71 H. Shift Shaft Assembly 71 I. Oil Pump Assembly 75 J. Final Assembly 75 <p>VIII. Torque Specifications 76</p> <p>IX. Tool Reference 78</p> <p>X. Parts Manual PM 1</p>
--	--

I. TC-140 TRANSFER CASE

A. General

The Fabco model TC-140 is one of a series of Fabco twospeed transfer cases developed for use in on/off highway vehicles. The TC-140 is nominally rated at 14,000 lbs.-ft. input torque capacity, and is equipped with an integral air shift mechanism. Spur gears are used throughout, and an oil pump provides lubrication. The TC-141 is the singlespeed version.

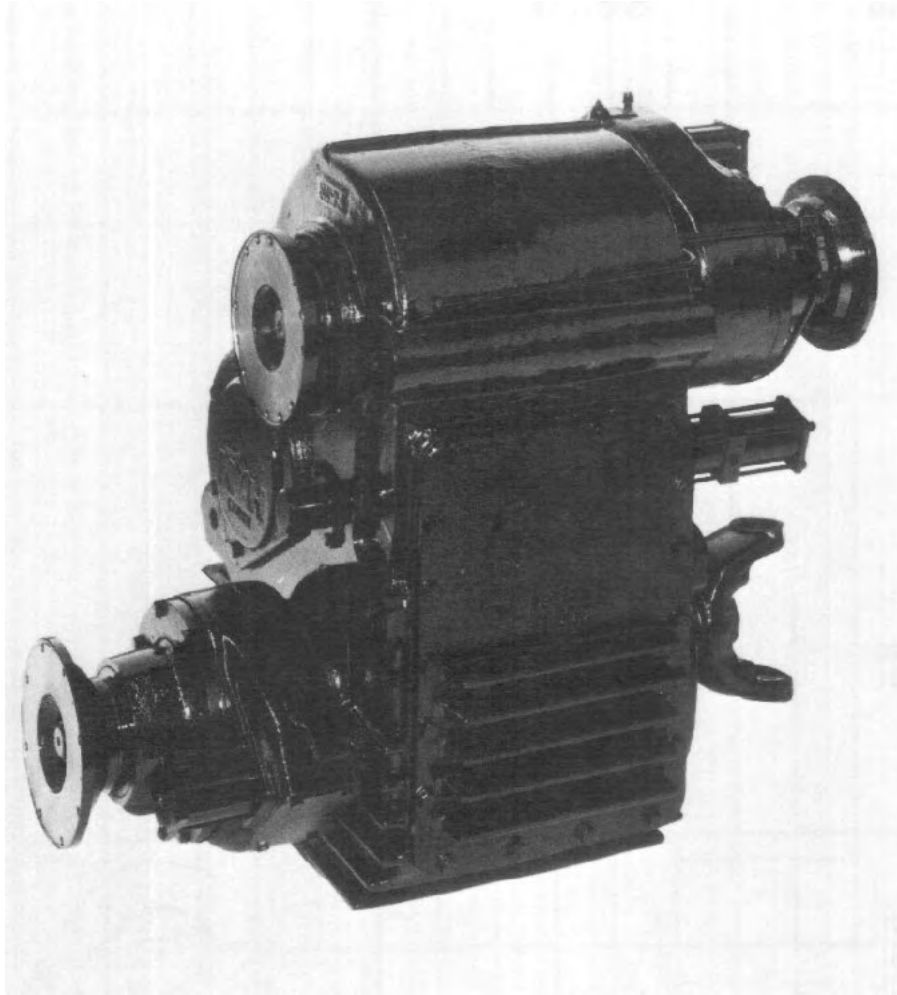

I. TC-140 TRANSFER CASE

Options:
 Full Power PTO
 Hydraulic Pump Flange
 Proportioning Differentials
 (26%/74%) or (50%/50%)

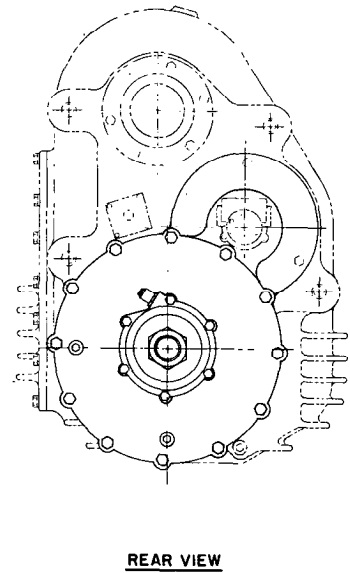
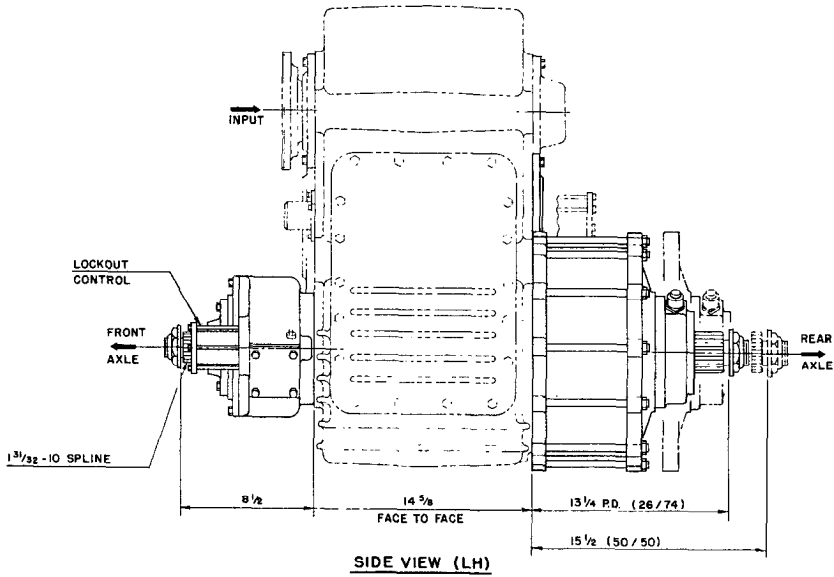
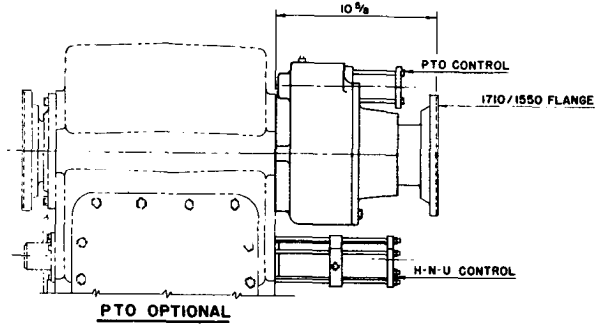
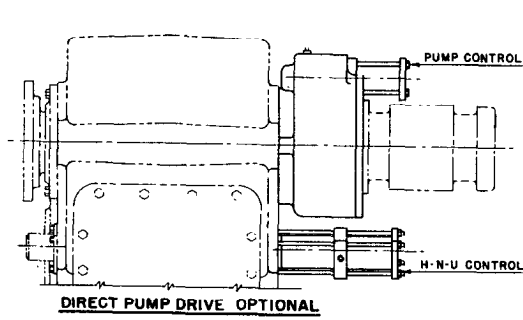

— NOTES —

II. OPERATING INSTRUCTIONS

A. General

All-wheel drive is operated by means of shift controls which engage and disengage gear clutches in the transfer case. The TC-140 Transfer Case is equipped with separate controls for front axle drive engagement and underdrive selection. The TC-140 transfer case with a proportioning differential is equipped with a differential lock rather than a front drive engagement control.

B. Front Drive Declutch

When traveling through sand, loose dirt, mud, snow, or ice, and ascending grades where rear wheels might spin, engage front axle drive for improved traction. Engagement can be made at any vehicle speed, unless the rear wheels are spinning, but is best accomplished while the engine is pulling lightly.

C. Proportioning Differential

When operating a differential equipped transfer case, leave the differential control in unlocked position for normal operation. Under poor traction conditions, the control may be shifted to the locked position.

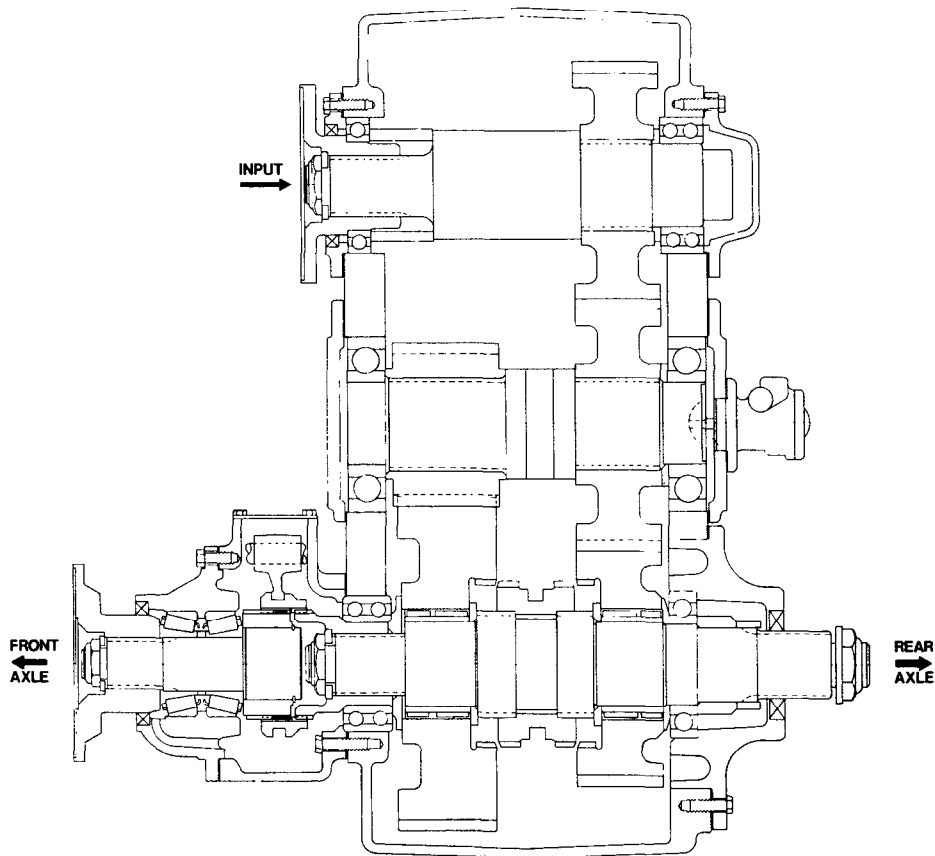

TC-140 Transfer Case without Proportional Differential

III. LUBRICATION

RECOMMENDED LUBRICANTS (In Order of Preference)

ON HIGHWAY VEHICLES

Heavy-duty engine oil. Make sure to specify heavy-duty type meeting MIL-L-2104 specifications.

Mineral gear oil inhibited against corrosion, oxidation and foam.

Type	Grade	Temperature
MIL-L-2104 Heavy Duty Engine Oil	SAE 50 SAE 30	Above + 10°F. Below + 10°F.
Mineral Gear Oil	SAE 90 SAE 80	Above + 10°F. Below + 10°F.
MIL-L-2105 E.P. Oil, except Sulfur-chlorine-lead type.	SAE 90 SAE 80	Above + 10°F. Below + 10°F.

OFF-HIGHWAY & MINING EQUIPMENT

MIL-L-2104 Heavy-Duty Engine Oil	SAE 50 SAE 30	Above + 10°F. Below + 10°F.
Special Recommendation — For extreme cold weather where temperature is consistently below 0°F.		
MIL-L-2104 Heavy-Duty Engine Oil	SAE 20W	Below 0°F.

A. Transfer Case Oil Change

Transfer case lubricant should be changed on all new transfer cases after the first 3,000 to 5,000 miles (on-highway), or first 40 hours (off-highway); thereafter, oil changes should be done at the following intervals:

On-Off Highway Service 10,000-15,000 miles

Off-Highway Service
Logging, dirt moving, mining
and associated operations 500-750 hours,
as indicated by operation and contamination of lubricant.

B. Draining Oil

Draining is best accomplished after the vehicle has been operated briefly, allowing the oil to become warm and flow freely. Remove both drain and level plugs and allow housing to empty completely. After transfer case has been drained and before it is refilled, the case should be thoroughly flushed with a clean flushing oil or kerosene.

C. Refilling Oil

Clean and replace drain plug and fill the transfer case with appropriate gear oil (see recommended lubricant chart). Fill transfer case to the level of the upper plug, metering approximately 20 qts. of gear oil into the transfer case. The exact amount may differ depending upon the inclination of the transfer case. Always fill to the level of the filler plug. Replace upper plug and examine transfer case for leaks around plugs and gasket sealed areas.

D. Inspection

Gear oil level is to be maintained at the level of the filler plug at all times. Check at the following intervals:

Highway Service 1,000 miles
Off-Highway Service 40 hours

E. Oil Change & Inspection Recommendations

The above oil change and inspection periods are based on the average use and operating conditions the transfer case may encounter. It is recommended that the individual owner make a periodic lab analysis of the lubricant to determine contamination based on the individual's own operating conditions. With this data the individual owner can better determine his own oil change and inspection periods.

F. Operating Temperature

The operating temperature of the transfer case should never exceed 250°F (120°C.)

Extensive operation at temperatures exceeding 250°F will result in rapid breakdown of the oil and shorten the transfer case life.

A transfer case used in any of the following conditions may have to be equipped with an external oil cooler to maintain the operating temperature of the case below or at 250°F:

1. A vehicle remaining in a stationary position for long periods of time while the transfer case is operating a pump or power take-off.
2. A vehicle which is used in tropical or semi-desert conditions.
3. A vehicle operating at slow road speeds.
4. A vehicle which is operating in densely overgrown plant growth that may tend to shield the transfer case from air ventilation and circulation.

G. Shift Cylinder Inspection

With every oil change the air shift cylinder lines and valves should be inspected for leaks and possible malfunctioning. Low pressure conditions and malfunctioning can cause partial gear engagement which may result in premature gear wear.

IV. REMOVAL & INSTALLATION

A. Removal

1. Remove fill and lower drain plugs and drain gear lubricant. Remove proportional differential drain plug and drain P.D. if so equipped.
2. Disconnect wires leading to indicator light switch, and temp. sensor, if used.
3. Disconnect and tag shift cylinder air lines.
4. Disconnect speedometer cable.
5. Disconnect drivelines at flanges or yokes.
6. If the transfer case is equipped with a PTO mounted hydraulic pump, remove four capscrews and slide pump out of PTO. Secure the pump to the frame to avoid damage to hydraulic lines. The pump should be secured in a position that will not hinder the removal of the transfer case.
7. Position a transmission jack of suitable capacity (1300 lbs.) beneath the transfer case. The transfer case must be seated on the jack in a safe and firm position.
8. Disconnect transfer case mountings at rubber shock insulators. Since mounting designs vary, consult vehicle service manual.
9. After inspecting that all mountings and connections to the transfer case are disconnected lower the transfer case gradually to the floor. It is imperative that the transfer case is ALWAYS safely positioned on the transmission jack to safeguard against the transfer case falling off the jack. Remove the transfer case from beneath the vehicle. It may be necessary to jack the truck up to allow room to remove transfer case.

B. Installation Into Vehicle

1. Place transfer case on transmission jack, lifting by means of the eye bolts. (See Section V-A-1.)
2. Position transmission jack underneath vehicle. Some vehicles may require that one side be jacked up in order to achieve sufficient clearance to replace the transfer case between the frame rails.
3. Raise the transmission jack to properly locate transfer case.
4. Connect transfer case mountings. Since mounting designs vary, consult vehicle service manual.
5. Connect drivelines.
6. Connect speedometer cable.
7. Connect shift cylinder air lines.
8. Connect indicator light and temperature sensor wires.
9. Fill housing with appropriate lubricant to correct level and install level plug. (Refer to lubrication, Section III).
10. Check transfer case for leaks around gaskets and seals.

V. TRANSFER CASE DISASSEMBLY

A. General Precautions For Disassembly

IMPORTANT: READ THIS SECTION BEFORE STARTING THE DISASSEMBLY PROCEDURES.

It is assumed in the disassembly instructions that the lubricant has been drained from the transfer case and the transfer case has been removed from the chassis.

Follow each procedure closely in each section, making use of both the text and pictures.

1. Obtain two forged eye bolts for lifting the transfer case. Install eye bolts in tapped holes provided. A bar or chain secured safely through the eye bolts provides a safe lifting point. ($\frac{3}{8}$ - 11 UNC eyebolts, see fig. 1)
2. The outside of the unit should be carefully cleaned before starting the disassembly. If steam cleaning, insure that breather and air fittings are covered to prevent water from entering assembly.
3. Cleanliness — Provide a clean place to work. It is important that no dirt or foreign material enters the unit during repairs.

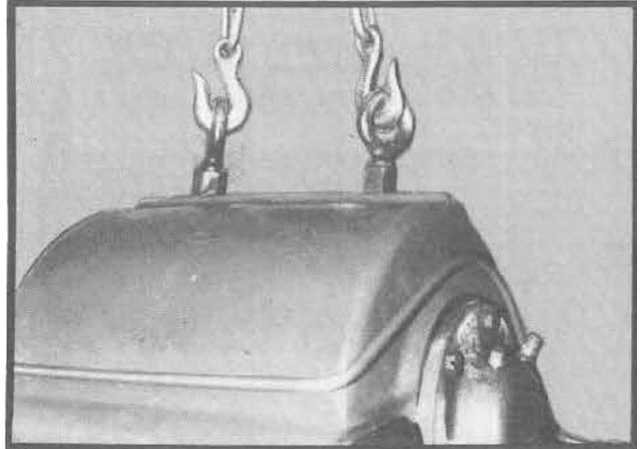
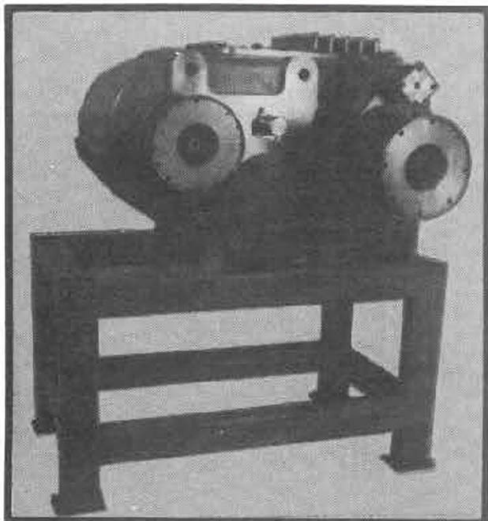

Fig. 1



4. Position the transfer case horizontally, with the cover plate facing upwards. A specially fabricated stand is desirable. (See photo at left and Tool Reference, Section X.)
5. Assemblies — When disassembling the various assemblies, lay all parts on a clean bench in the same sequence as removed. This procedure will simplify reassembly and reduce the possibility of losing parts.

6. Remove temperature sensor if installed. Disconnect and remove all oil lines on the transfer case. (See fig. 2)
7. Remove cover plate capscrews and lockwashers. Tap cover plate with a soft hammer to break loose and remove.
8. Bearings — Carefully wash and relubricate all bearings as removed and protectively wrap until ready for use. Remove bearings with pullers designed for this purpose, or in manner which will not damage those bearings that will be reused.
9. Snap Rings — Remove snap rings with pliers or special tools designed for this purpose, Rings removed in this manner can be reused.
10. When necessary to apply a force to remove a part, use of a puller or press would be preferred. However, sometimes it may be necessary to use a soft hammer or bar.

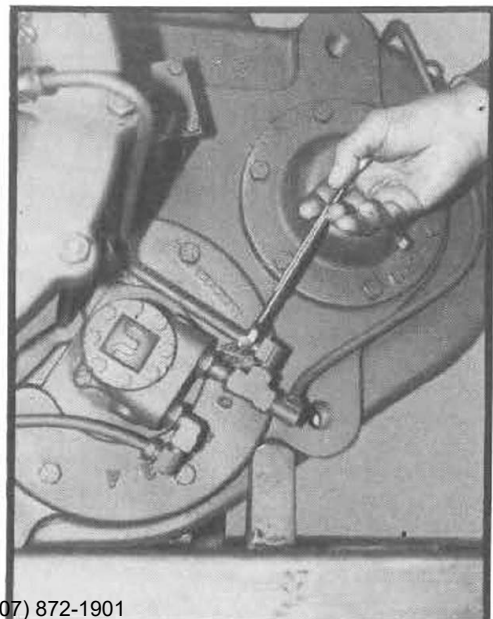

Fig. 2

V. TRANSFER CASE DISASSEMBLY

B. PTO And Declutch Assembly

1. Remove eight capscrews holding PTO/declutch carrier to PTO/declutch housing. (See fig. 3.)
2. Tap carrier to loosen and withdraw carrier and output shaft assembly.
3. Unscrew warning light switch from PTO/declutch housing and remove spacer washers. Remove plunger from inside PTO/declutch housing using a magnet.

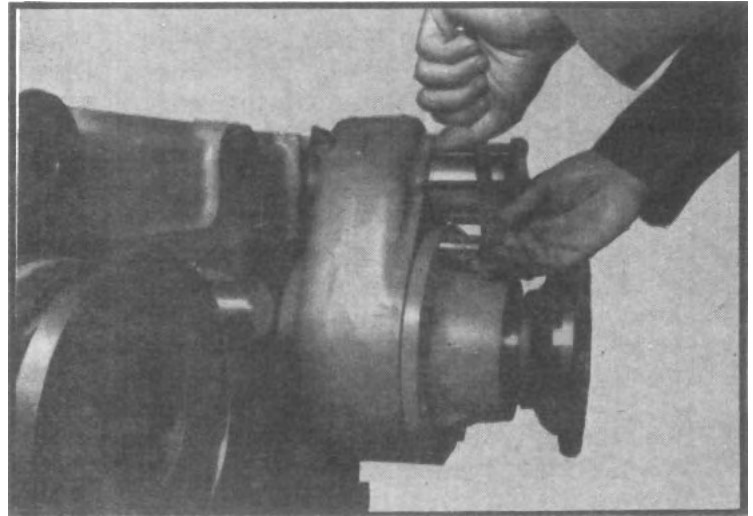

Fig. 3

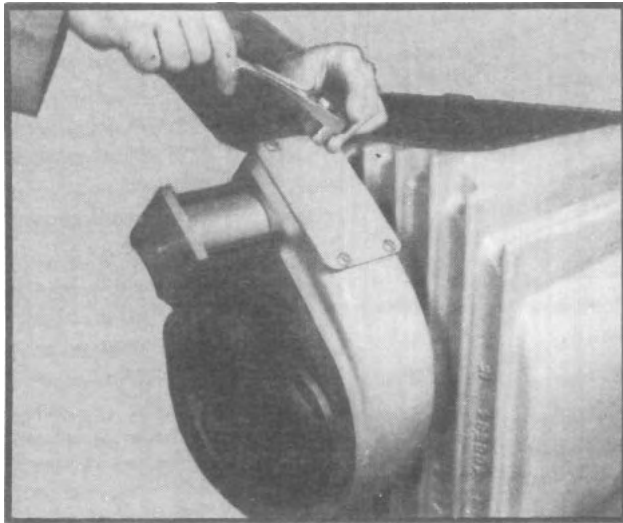

Fig. 4

4. Remove four capscrews from PTO/declutch cover plate, and tap plate to loosen. (See fig. 4.)
5. Cut the lockwires and remove the shift fork clamping screws.
6. Remove four long capscrews from shift cylinder, and lift off cylinder cap.



Fig. 5

7. Withdraw shift piston and shift shaft as a unit. (See fig. 5.)

Remove shift cylinder, adapter tube, and stop ring, discarding o-rings.

9. Remove nut from shift shaft and lift off the piston and spring, discarding o-rings and felt wiper.



Fig. 6

10. Withdraw shift fork and clutch collar. (See fig. 6.)
11. Remove six capscrews holding PTO/declutch housing to main case. Remove the declutch housing by tapping it with a soft hammer loosening it from the main case.
12. Remove companion flange lock nut and washer from carrier and output shaft assembly, discarding nut. Use a new nut for reassembly.
13. Slide companion flange off output shaft.

V. TRANSFER CASE DISASSEMBLY

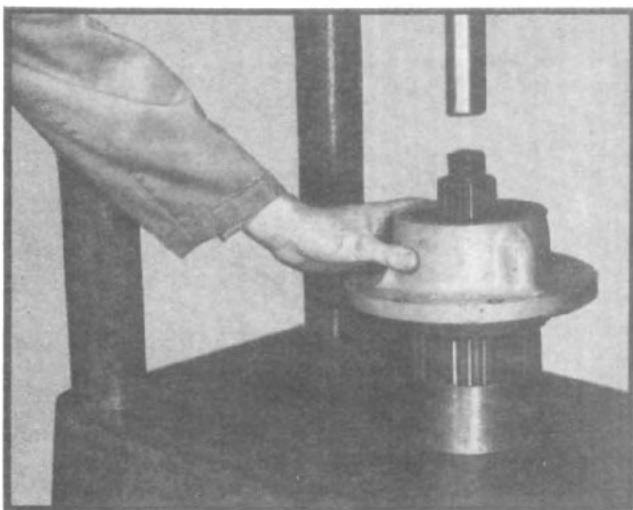

Fig. 7

14. To press output shaft from PTO/declutch carrier and clutch gear, press against threaded end of shaft while supporting by the clutch gear. (See fig. 7.)
15. Remove output seal, bearings, and end play spacer from PTO/declutch carrier, discarding seal.
16. Remove bearing cups from the PTO/declutch carrier, only if they are to be replaced.

C. Lockout Disassembly

Note: Proportional differential cases only.

1. Remove companion flange lock nut and washer from front of shaft, discarding nut, use a new nut for reassembly.
2. Slide companion flange off output shaft.
3. Remove capscrews from seal carrier. Tap carrier to loosen and remove. (See fig. 8.)

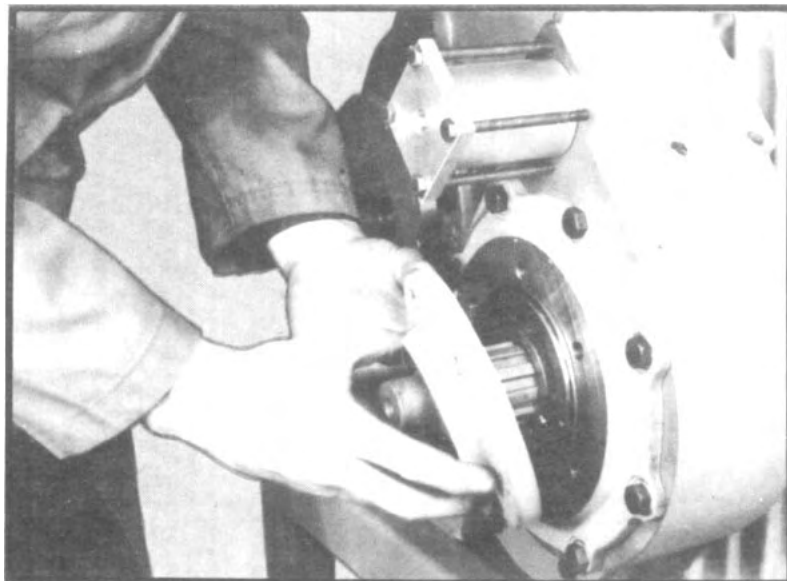

Fig. 8

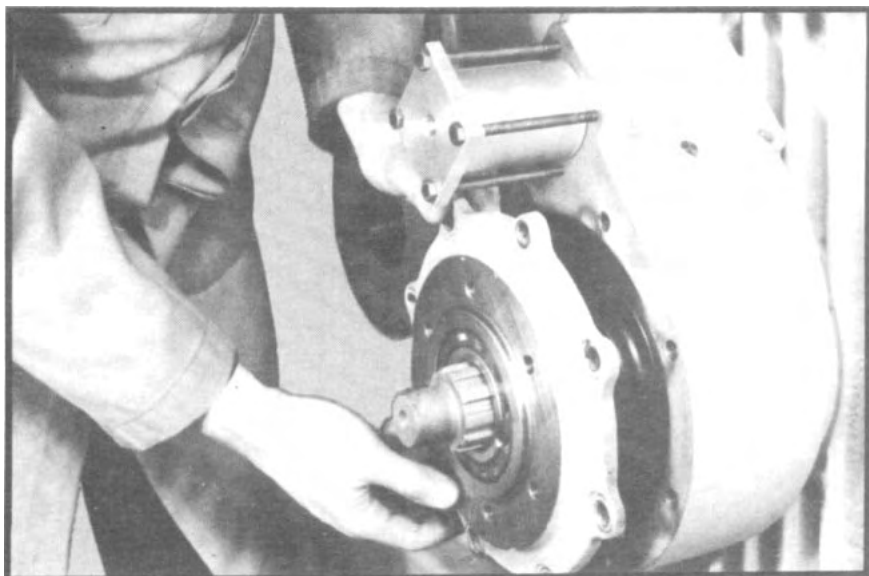

Fig. 9

4. Remove eight capscrews from lockout and bearing carrier and tap carrier to loosen. (See fig. 9.)
5. If the seal is to be replaced remove the seal from the seal carrier with a hammer and punch. Removal procedure will damage the seal and removal should not be attempted unless replacement of the seal is planned. Remove bearing from bearing carrier.

V. TRANSFER CASE DISASSEMBLY

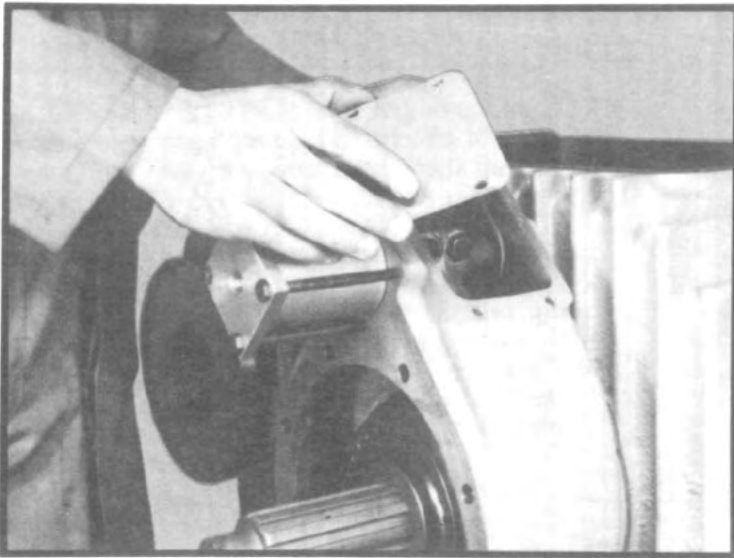

Fig. 10

6. Unscrew warning light switch from lockout housing and remove spacer washers. Remove plunger from inside housing using a magnet.
7. Remove four capscrews from lockout cover plate. Tap plate to loosen and remove. (See fig. 10.)

8. Cut the lockwires and remove the shift fork clamping screws. (See fig. 11.)

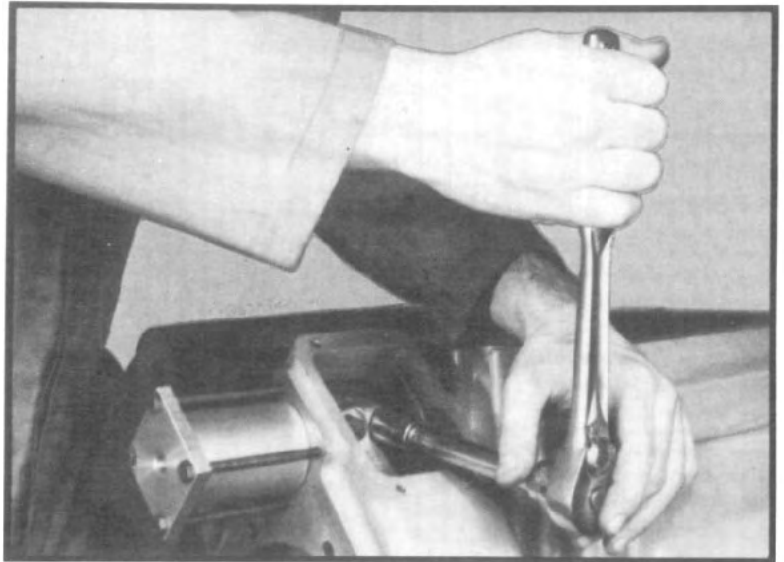
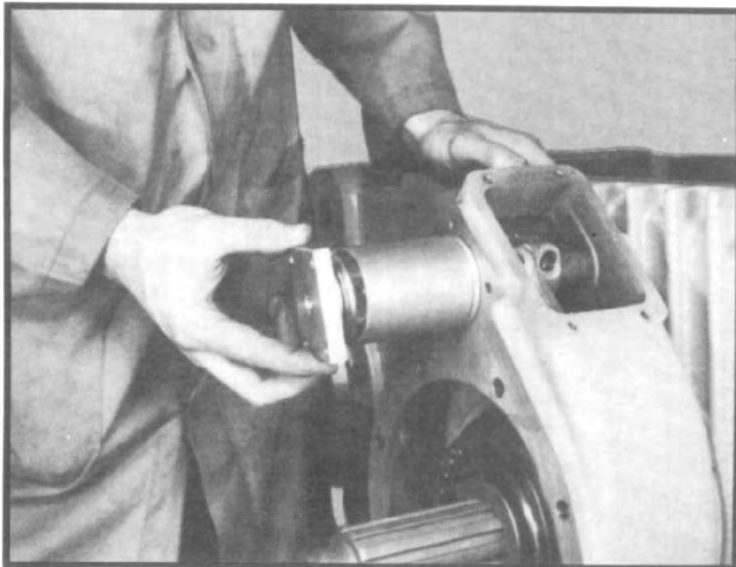

Fig. 11

9. Remove four long capscrews from shift cylinder, and lift off cylinder cap. (See fig. 12.)



V. TRANSFER CASE DISASSEMBLY

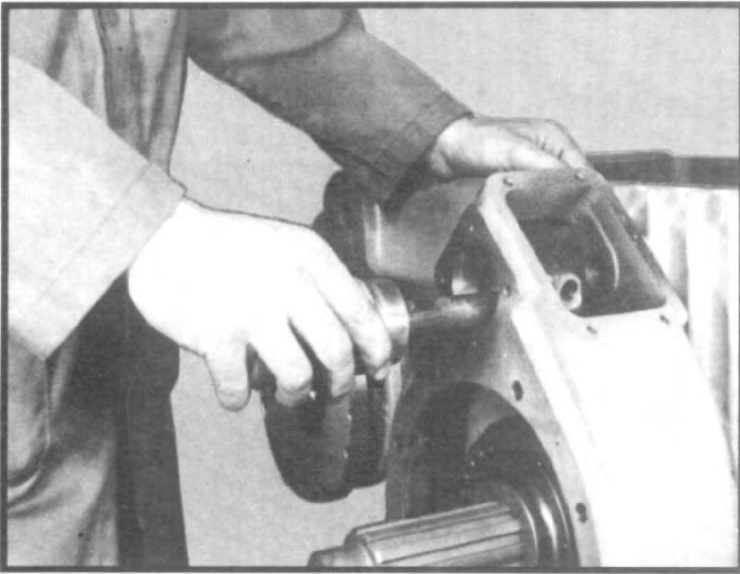

Fig. 13

10. Withdraw shift piston and shift shaft as a unit. (See fig. 13.)
11. Remove shift cylinder, adapter tube, and stop ring, discarding o-rings.

12. Remove nut from shift shaft and lift off the piston and spring, discarding o-rings and felt wiper.
13. Withdraw lockout gear, (See fig. 14), shift fork and clutch collar. (See fig. 15.)
14. Remove six capscrews holding lockout housing to main case. Remove the lockout housing by tapping it with a soft hammer, loosening it from the main case. (See fig. 16.)

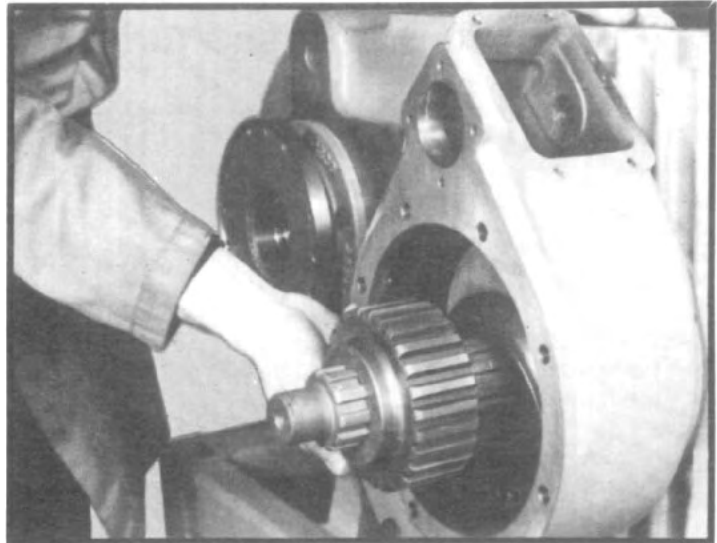
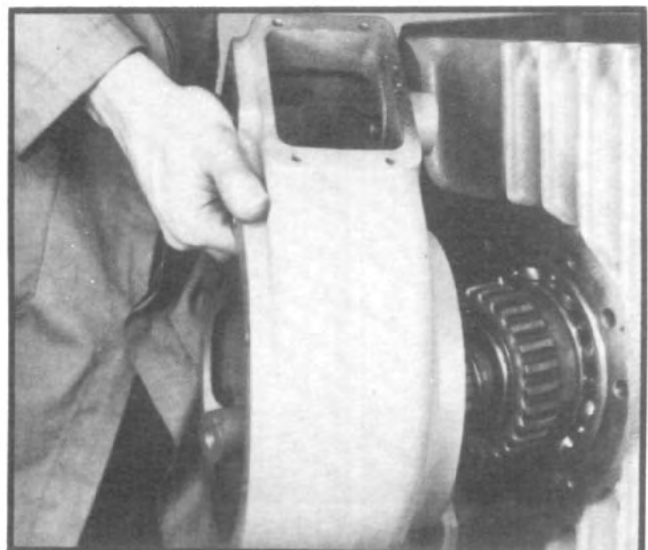
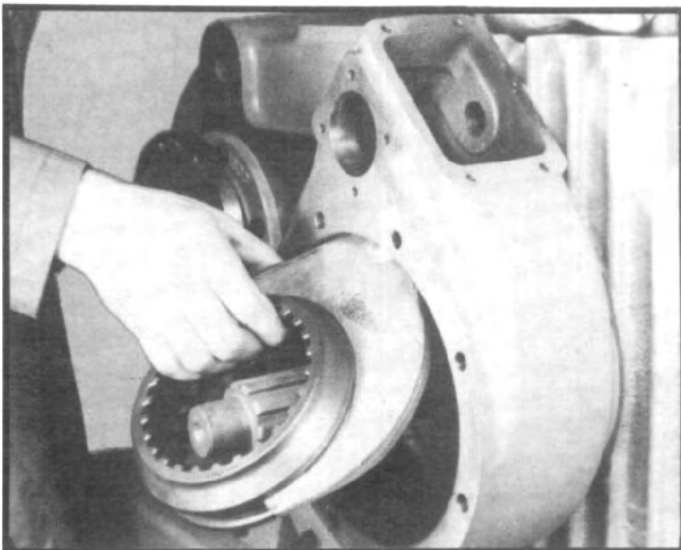

Fig. 14



V. TRANSFER CASE DISASSEMBLY

D. Direct Pump Drive Disassembly

1. Remove four capscrews holding pump to mounting plate and withdraw pump.
2. Loosen setscrews and slide clutch gear off pump shaft.
3. Remove eight capscrews from mounting plate and tap to loosen.
4. Refer to section V-B and follow steps 3 - 11.

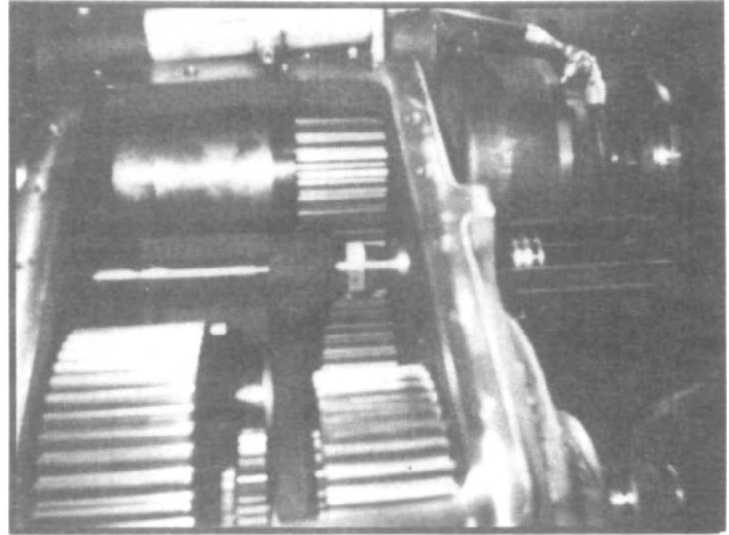

Fig. 17.A New Shift Shaft

E. Shift Shaft Disassembly

Case cover having been previously removed:

OLD STYLE:

1. Cut the lockwires and remove shift fork clamping bolts. (See fig. 17.)

NEW STYLE:

1. Remove rear shiftshaft cap & loosen jam nut on shiftshaft. (See Fig. 17A.)
2. Remove four long capscrews or stud nuts from shift cylinder, and lift off cylinder cap discarding o-ring.
3. If transfer case is not equipped with neutral position for PTO operation skip to step eight.

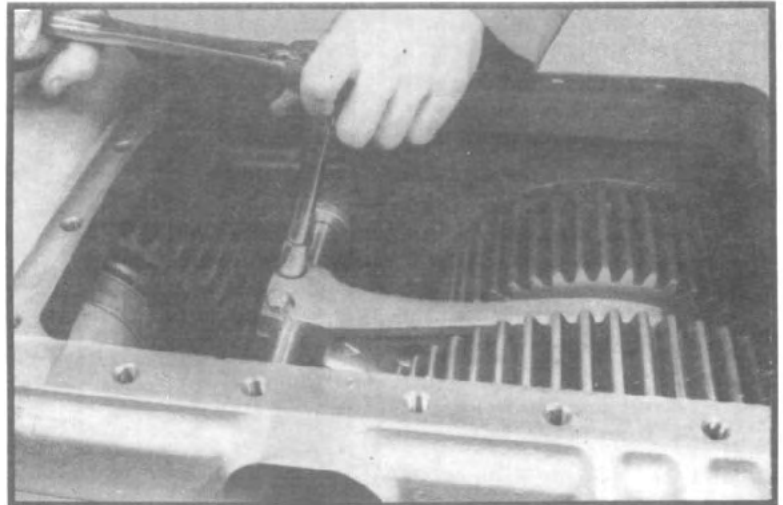
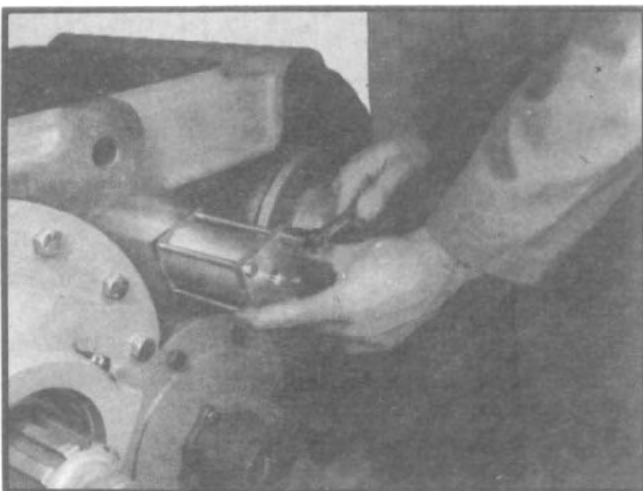
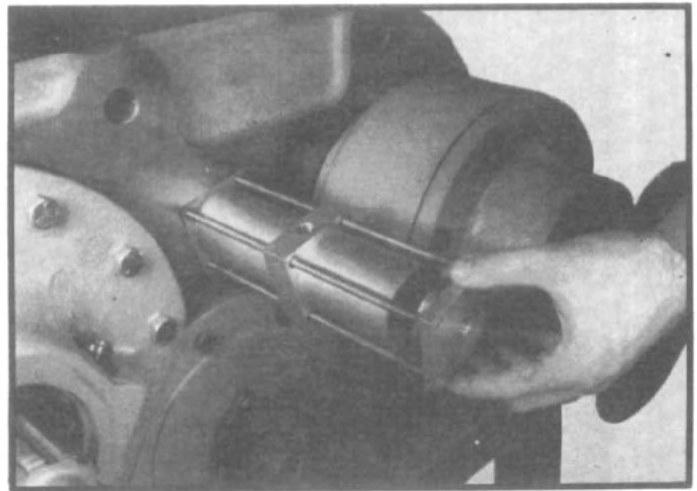

Fig. 17



High-Underdrive Shift Cylinder



High-Neutral-Underdrive Shift Cylinder

V. TRANSFER CASE DISASSEMBLY

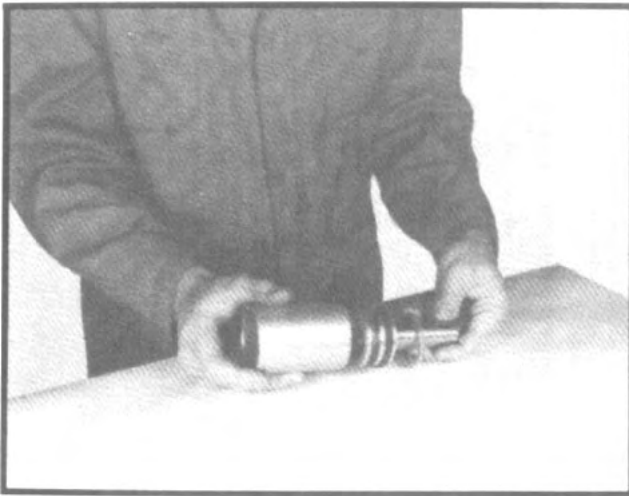

Fig. 18

4. Remove outer shift cylinder tube and outer piston as a unit. (See fig. 18.)
5. Withdraw outer piston, neutral shaft, and stop ring from the cylinder tube.
6. Remove nut and washer from shifter shaft and lift off the piston, discarding o-ring and felt wiper.

7. Remove neutral cylinder adapter, discarding o-rings. (See fig. 19.)

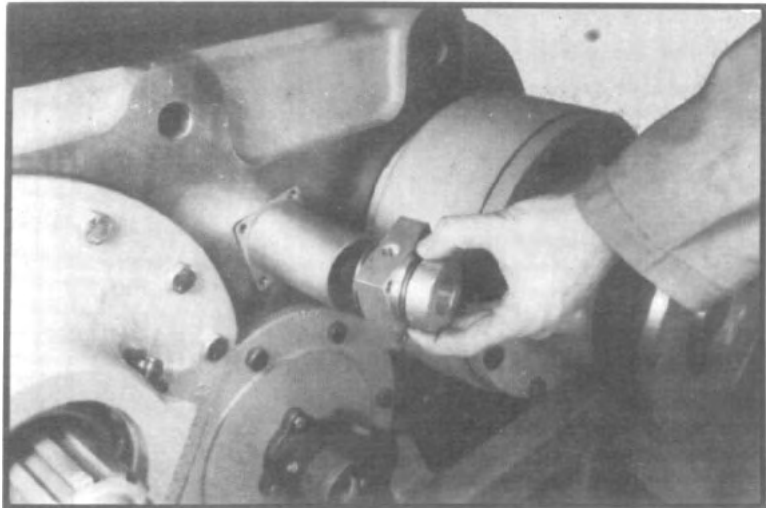

Fig. 19

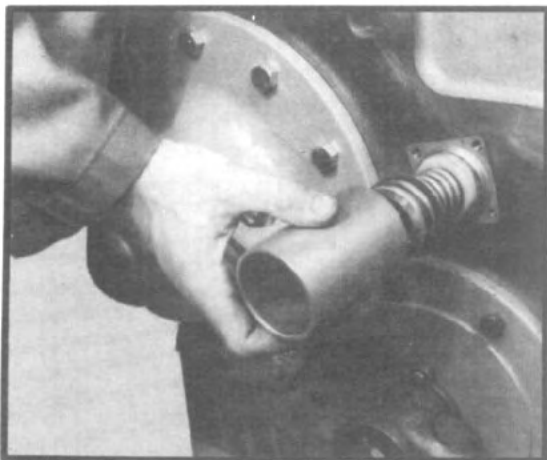
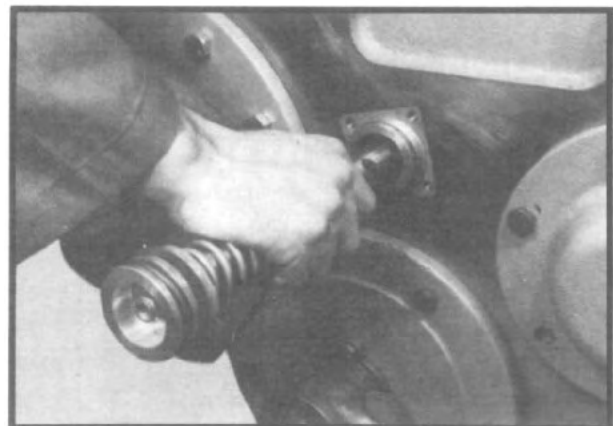

Fig. 20

8. Remove shift cylinder tube from the adapter in the transfer case, exposing piston. (See fig. 20.)



9. Using a hexwrench, unscrew shaft from fork, running jam nut down and off shaft. Withdraw shift piston and shifter shaft from case (See fig. 21.)
10. Remove the stop ring and spring from shifter shaft.

Fig. 21

V. TRANSFER CASE DISASSEMBLY

11. Remove the adapter tube from the case. Discard the o-ring from adapter tube. (See fig. 22.)
12. Remove nut and washer from shift shaft and lift off piston, discarding o-ring and felt wiper.

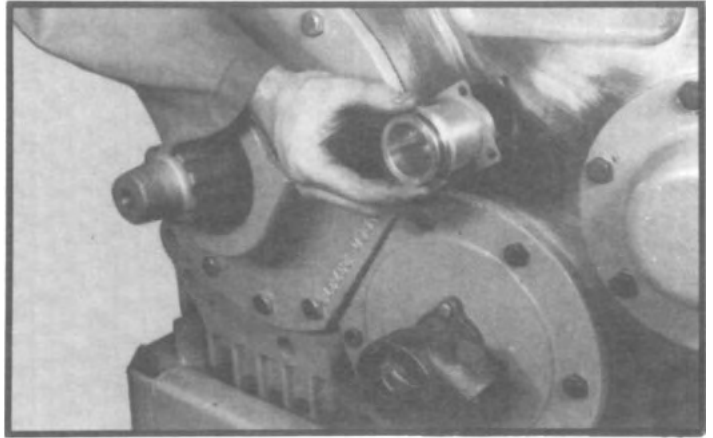

Fig. 22

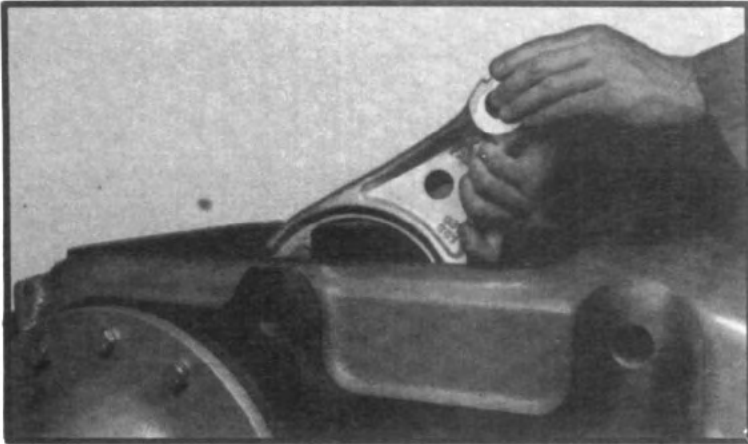

Fig. 23

13. Remove shift fork from inside case, (See fig. 23.)

OLD STYLE:

14. Remove four capscrews from shift shaft cap (located at front of case) and tap shift shaft cap free.)

Note: If transfer case is equipped with a neutral position shift cylinder, remove four studs from case to prevent damage to the studs.

F. Upper Shaft Disassembly

1. If case is equipped with PTO or direct pump drive, refer to Section V-B, or V-D for appropriate disassembly procedure.
2. If case is not so equipped, remove six capscrews and tap upper rear cap loose.
3. If transfer case is equipped with a PTO or direct pump drive, remove locking bolt from rear of shaft. (See fig. 24.) Remove special washer, declutch gear and spacer washer from rear of shaft. Discard locking bolt, which should be replaced for assembly. (See fig. 25.)

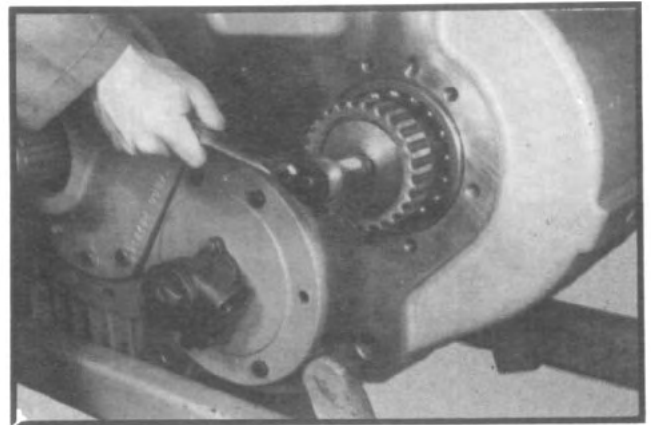

Fig. 24

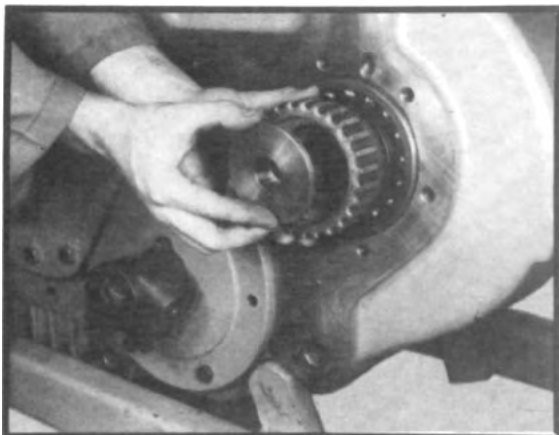

Fig. 25

4. Remove input companion flange lock nut and washer, discarding nut, use a new nut for reassembly.
5. Slide companion flange off input shaft.

V. TRANSFER CASE DISASSEMBLY

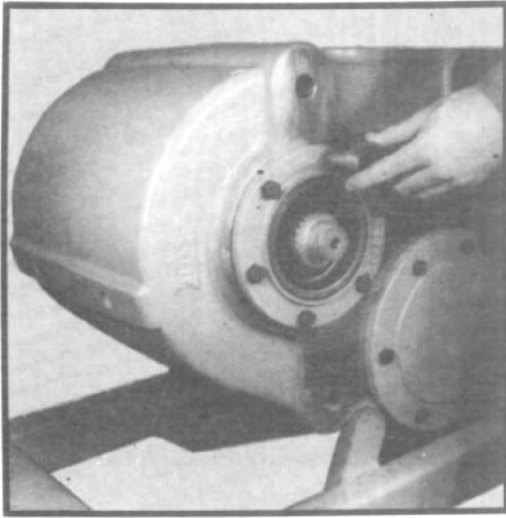

Fig. 26

6. Remove six capscrews from seal carrier and tap to loosen. (See fig. 26.)

7. Remove seal from carrier and discard.

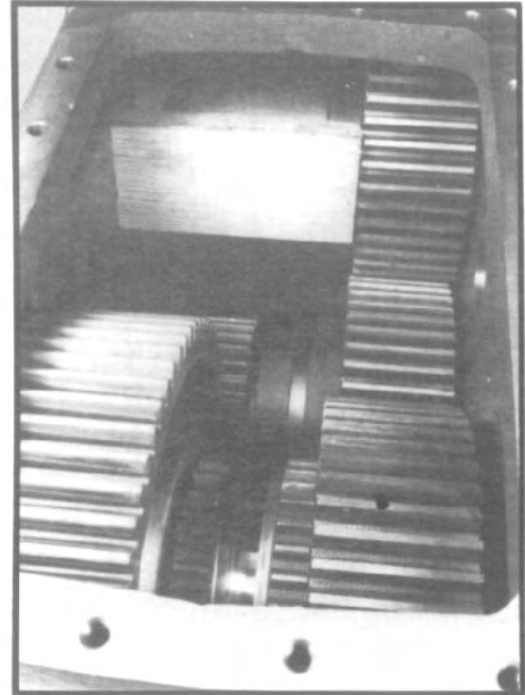

Fig. 27

8. Place a block of wood between input gear and inside of housing (See fig. 27) and drive input bearing outwards by tapping with a soft hammer on the rear of the input shaft until bearing is out of housing. (See fig. 28.)

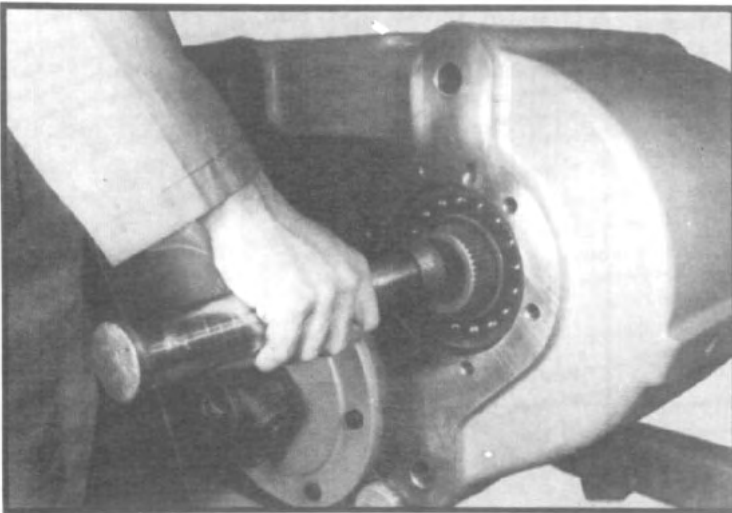

Fig. 28

9. Withdraw spacer tube from input shaft through front bearing bore. (See fig. 29.)

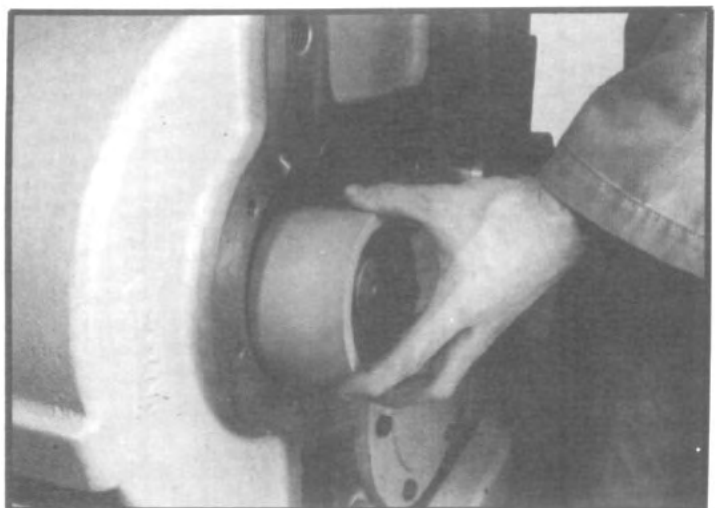

Fig. 29

V. TRANSFER CASE DISASSEMBLY

10. Continue to tap on the rear of the shaft until shaft is free from rear bearing and withdraw shaft and spacer ring (located between shaft and input gear) from front of case. Use care to prevent damage to input gear as shaft pulls free. Remove block of wood. (See fig. 30.)

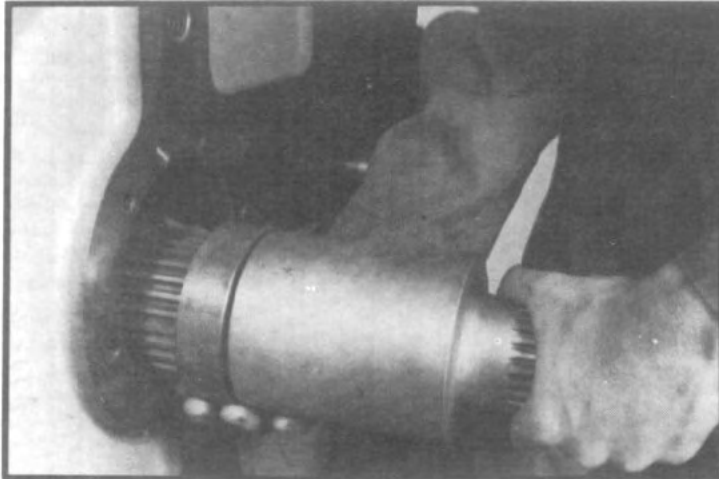

Fig. 30



Fig. 31

11. Remove input gear from transfer case. (See fig. 31.)
12. Retrieve the spacer ring (located between the input gear and rear bearing) which will have fallen to the bottom of the case on removal of upper shaft.
13. Tap out rear bearing with a suitable driver.

V. TRANSFER CASE DISASSEMBLY

G. Lower Shaft Disassembly

1.0 Lower Shaft Disassembly With Standard Case

- 1.1 Refer to section V-B and remove declutch assembly.
- 1.2 Unscrew speedometer drive sleeve from rear seal carrier and withdraw speedometer driven gear.
- 1.3 Remove flange or yoke locknut and washer from rear of shaft, discarding nut, use a new nut for assembly.
- 1.4 Slide flange or yoke off rear shaft.
- 1.5 Remove locknut and washer from front of lower shaft, discarding locknut, use a new nut for assembly.
- 1.6 Remove eleven capscrews holding speedometer gear carrier to main housing, tap carrier lightly to break loose, and remove from housing by tapping with a soft hammer on front of the lower shaft. (See fig. 32)
- 1.7 Remove output shaft seal from speedometer gear carrier with a suitable tool and discard.

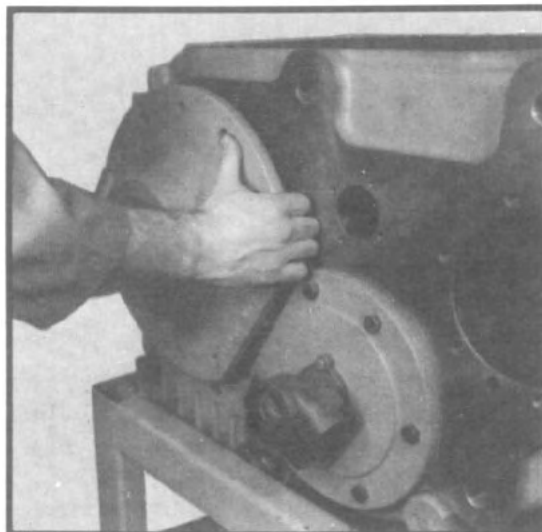

Fig. 32

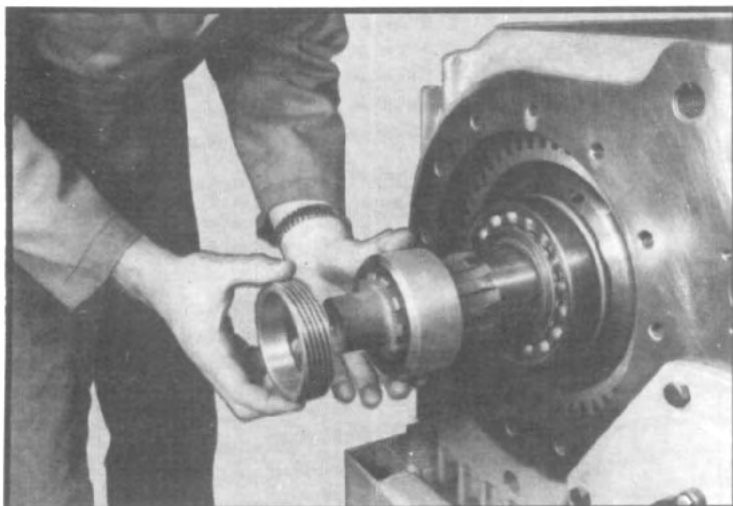

Fig. 33

- 1.8 Remove speedometer drive gear and spacer from shaft. (See fig. 33.)
- 1.9 Supporting weight of underdrive gear, remove clutch gear with bearing from front of shaft. (See fig. 34.)
- 1.10 Remove front bearing from clutch gear with a suitable puller.

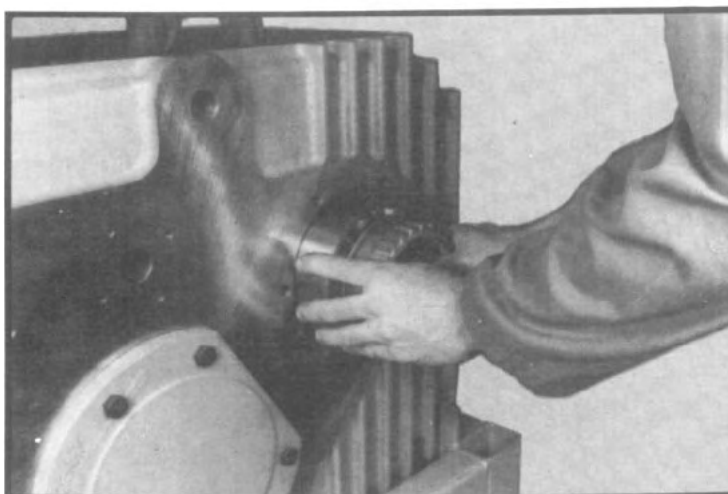

Fig. 34

V. TRANSFER CASE DISASSEMBLY

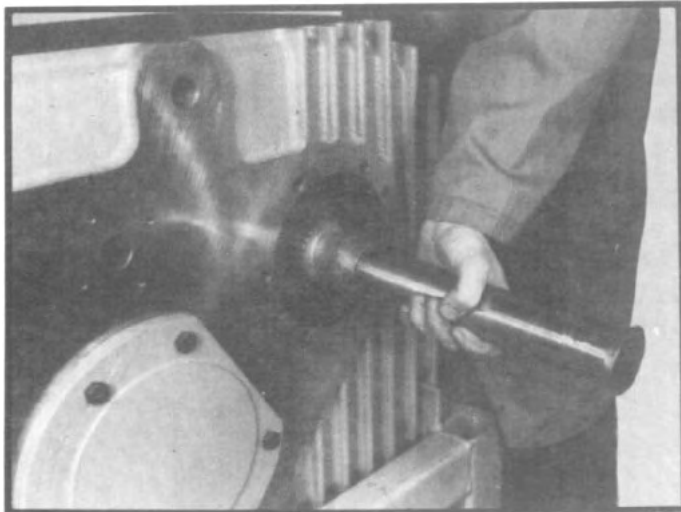

Fig. 35

- 1.11 Drive lower shaft assembly from case by tapping with a soft hammer on the front of the shaft. (See fig. 35.) The direct drive gear will have to be aligned with the rear case bore for shaft assembly to be removed. (See fig. 36.) Attach a chain hoist with a sling around the direct drive gear and remove the shaft assembly through the rear case bore. (See fig. 37.) Remove the needle bearing assemblies and spacer ring for the underdrive gear from the shaft or from inside the underdrive gear.

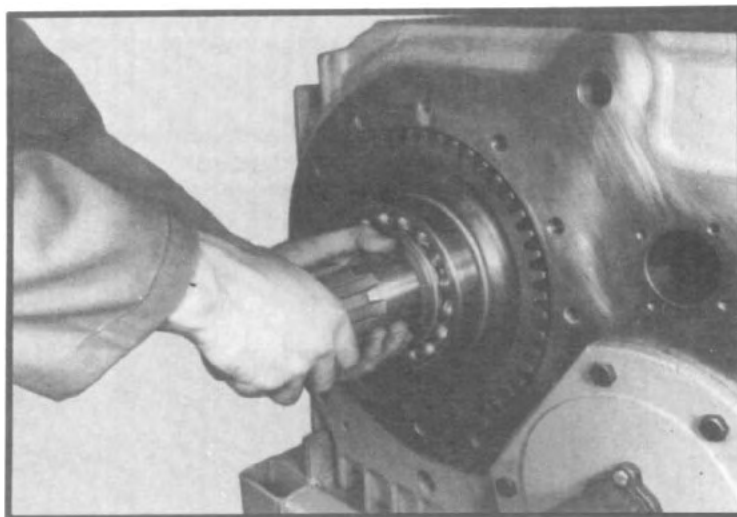

Fig. 36

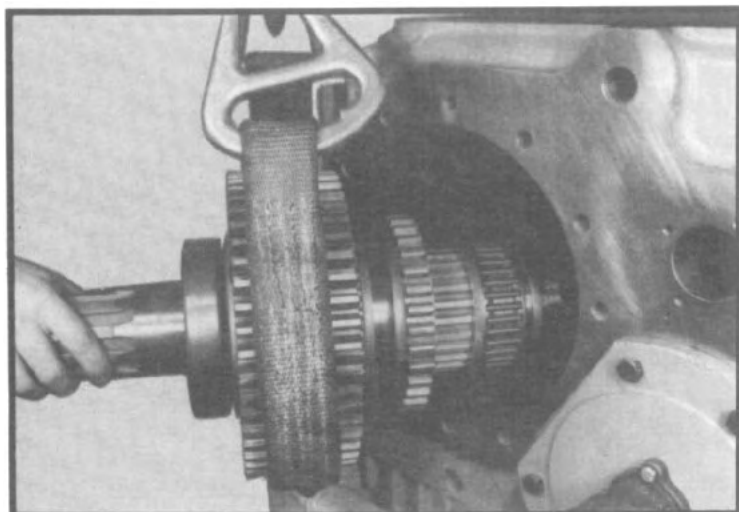

Fig. 37

V. TRANSFER CASE DISASSEMBLY

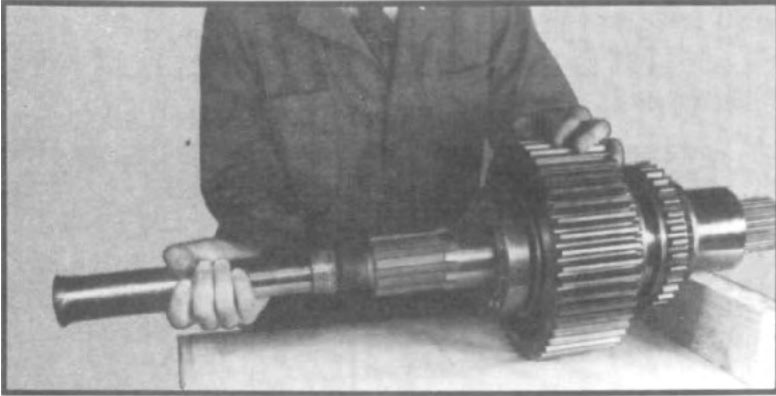

Fig. 38

1.12 Disassemble the shaft assembly by placing the front of the shaft on a block of wood for support. Tap with a soft hammer on the rear of the shaft, pushing the shaft through the direct drive gear and pushing the rear bearing and thrust washer from the shaft. (See fig. 38.)

1.13 When the rear bearing and thrust washer have been removed, remove the direct drive gear from the shaft. Remove needle bearing assemblies from inside the gear or from the shaft.

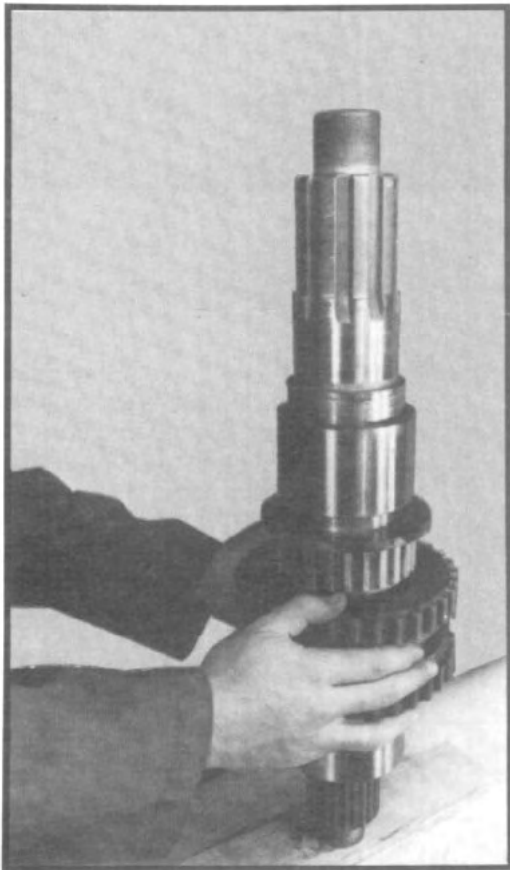

Fig. 39

1.14 If necessary to remove the needle bearing inner races and thrust rings from the shaft, place the shaft vertically on a table and tap the clutch gear on the thrust washer. This procedure will push the inner race off the shaft. Repeat this operation for the opposite side. (See fig. 39.)

1.15 Remove the clutch collar from the shaft.

1.16 Lift the underdrive gear out of the case. (See fig. 40.)

1.17 Retrieve the front thrust washer which will have fallen to the bottom of the case on removal of the lower shaft assembly.

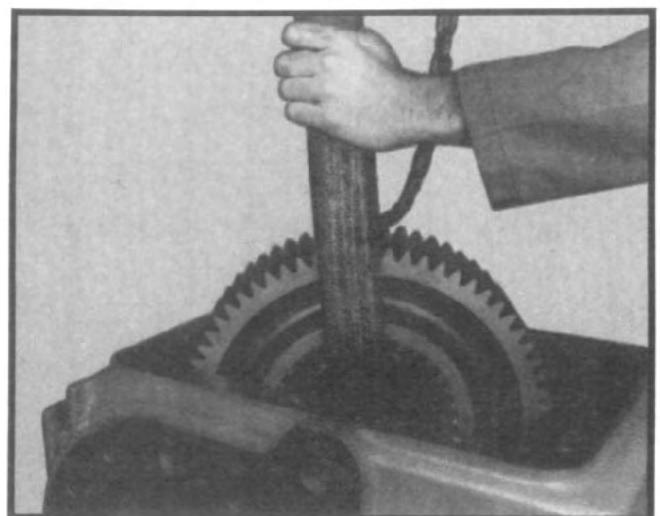

Fig. 40

V. TRANSFER CASE DISASSEMBLY

2.0 Lower Shaft Disassembly with 50/50 Differential

Note: Lockout assembly having been previously removed.

- 2.1 Remove flange or yoke locknut and washer from rear of shaft, discarding nut, use a new nut for reassembly.
- 2.2 Slide flange or yoke off rear shaft.
- 2.3 Unscrew speedometer drive sleeve from rear seal carrier and withdraw adapter tube and speedometer driven gear.

Note: Mark differential cap, differential housing and rear face plate before disassembly. Align marks on reassembly.

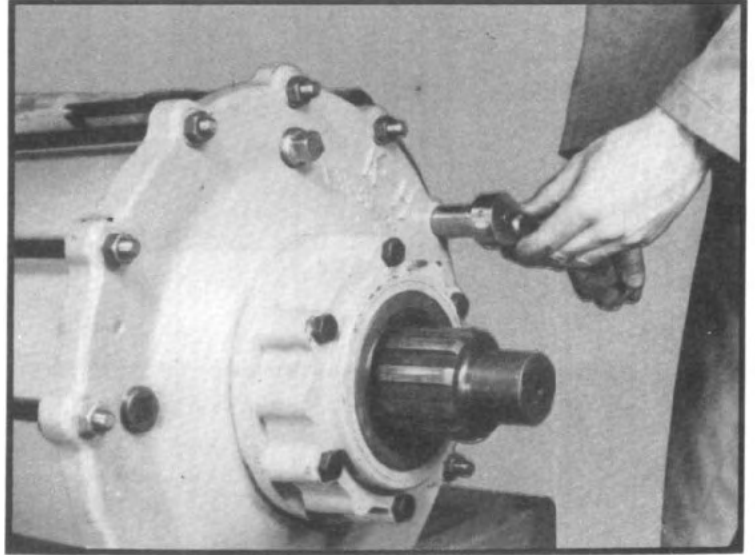

Fig. 41

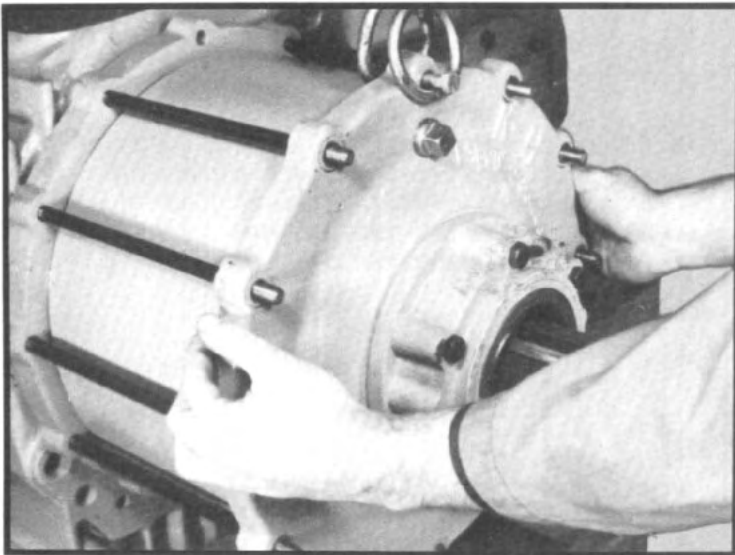

Fig. 42

- 2.4 Remove 12 stud nuts from studs. (See fig. 41.) Remove a top stud and install a bolt or eyebolt to differential cap through stud hole. Using a chain hoist fastened to the bolt or eyebolt, tap the differential cap until it is free from the studs. (See fig. 42.) Pull cap away from differential until it is free from the splines in the differential. (See fig. 43.)

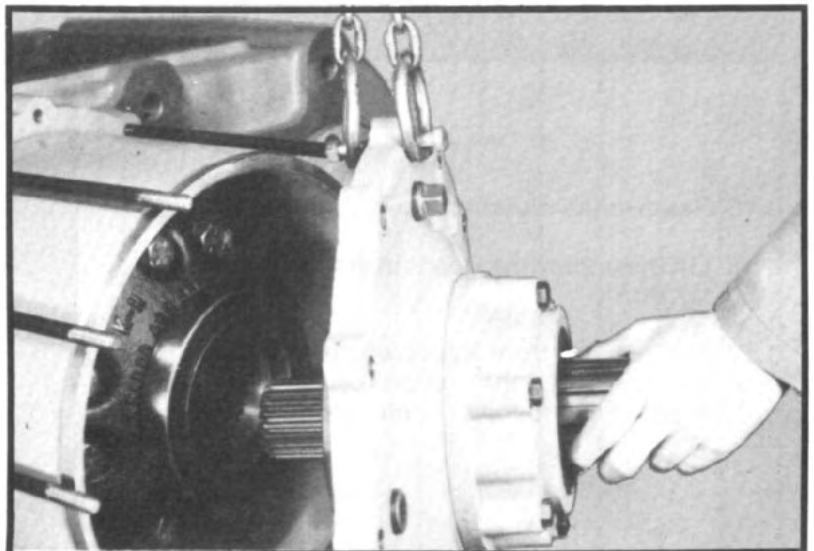

Fig. 43

V. TRANSFER CASE DISASSEMBLY

- 2.5 Remove six capscrews holding seal carrier to differential carrier cap. Tap seal carrier to loosen and remove. (See fig. 44.) If the seal is to be replaced remove the seal from the seal carrier. Removal procedure will damage the seal and removal should not be attempted unless replacement of the seal is planned.
- 2.6 Remove speedometer drive gear and spacer from shaft.

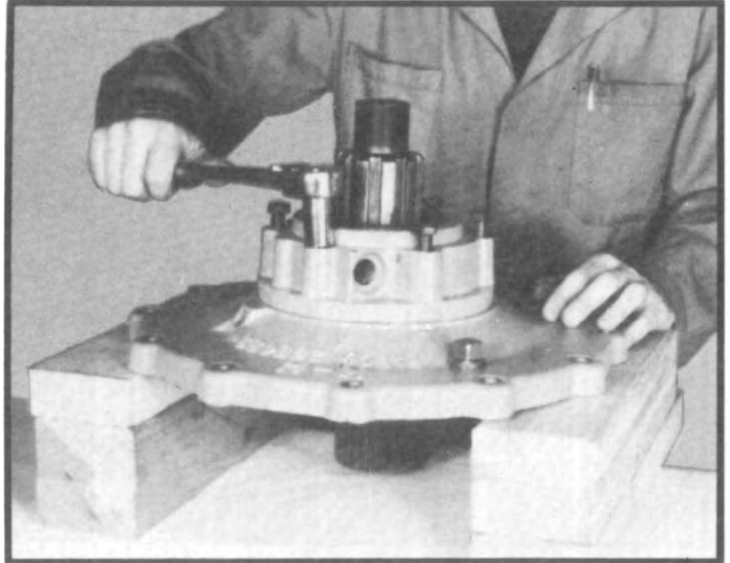

Fig. 44



Fig. 45

- 2.7 Tap rear output shaft and ball bearing from differential cap with a soft hammer. Remove large diameter o-ring from differential cap. (See fig. 45.)

- 2.8 Press rear output shaft from ball bearing.

- 2.9 Tap differential housing to loosen and remove. (See fig. 46.)
- 2.10 Remove studs from rear face plate.
- 2.11 Remove bearing from rear of differential case with a suitable puller if bearing is to be replaced.

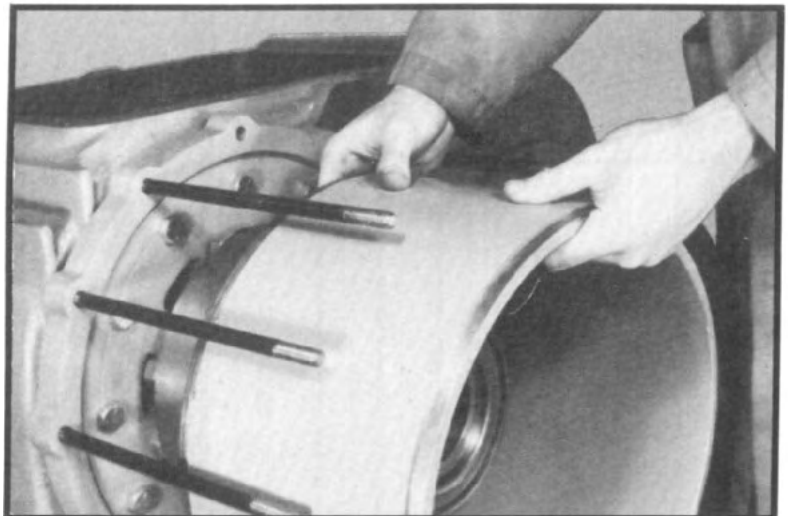

Fig. 46

V. TRANSFER CASE DISASSEMBLY

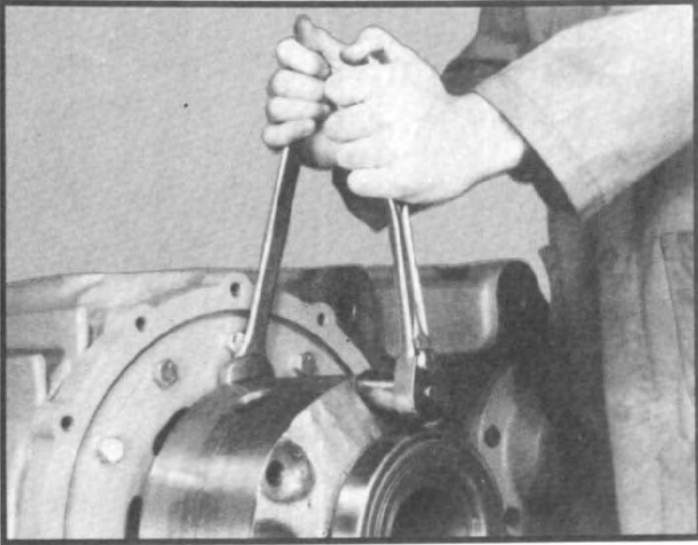

Fig. 47

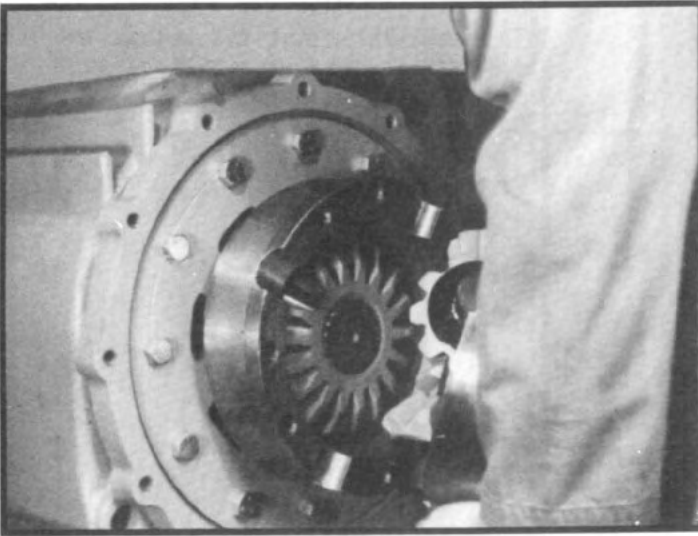

Fig. 48

2.12 Remove bolts from differential case, (See fig. 47), split the case and remove rear of case. (See fig. 48.) As the rear of the case is removed be sure to also remove the spider and pinion gear assembly with the rear of case (Do not let spider and pinion gear assembly drop from case). Remove spider and pinion gear assembly, differential side gear and thrust washer from case half. The differential spider, thrust washers and pinion gears do not have to be disassembled.

2.13 Remove differential side gear and thrust washer from inner shaft. (See fig. 49.)

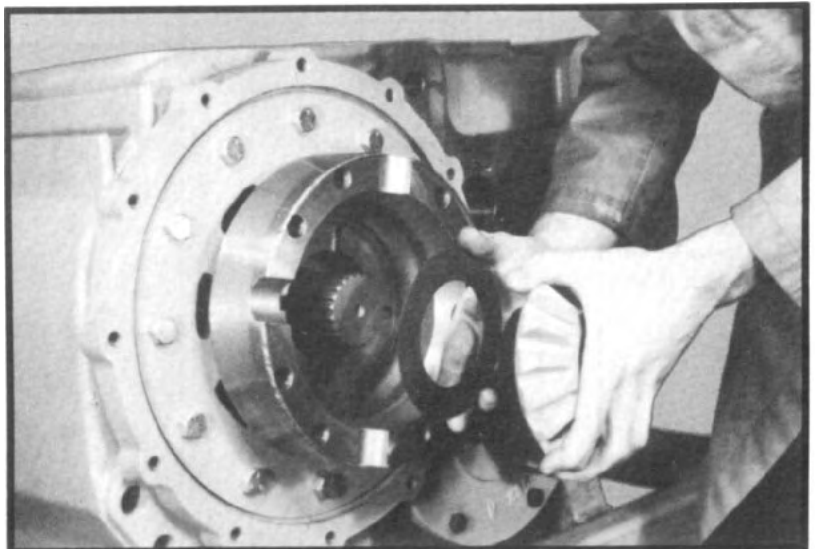

Fig. 49

V. TRANSFER CASE DISASSEMBLY

- 2.14 Remove retaining ring from front of inner shaft and remove inner shaft from lower shaft. (See fig. 50.)
- 2.15 Remove three capscrews holding oil pump to rear face plate.
- 2.16 Tap pump lightly to loosen and withdraw pump. (See fig. 51.)

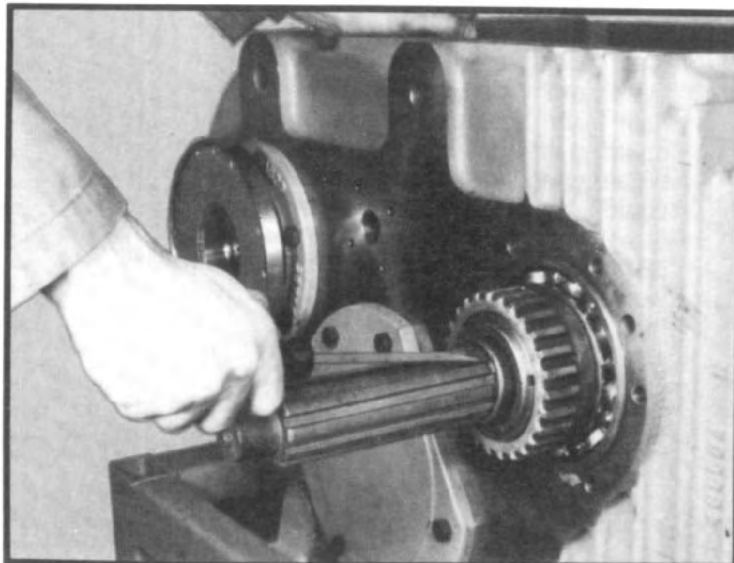

Fig. 50

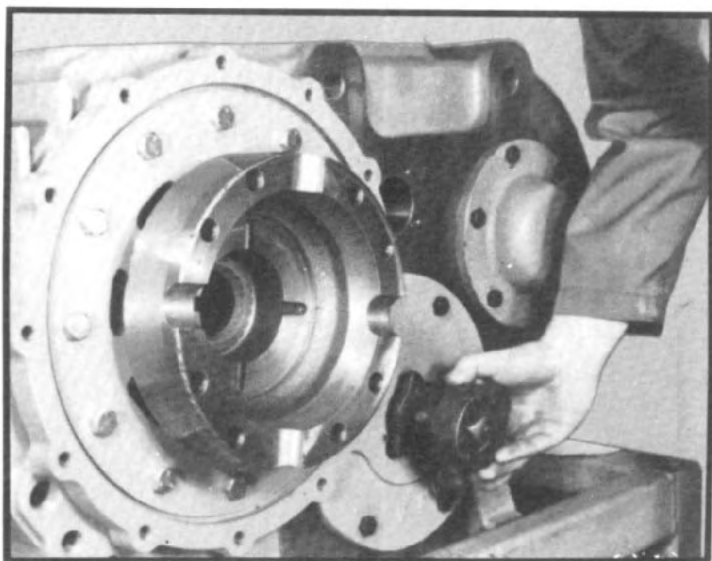

Fig. 51

V. TRANSFER CASE DISASSEMBLY

- 2.17 Remove fifteen capscrews from rear faceplate and remove face plate and differential case front half from housing. It is recommended that two bolts or eyebolts be attached to the face plate and a chain hoist be attached to the bolts or eye bolts with a chain. (See fig. 52.) The face plate can then be worked out of transfer case housing, supported by the chain hoist. (See fig. 53.)

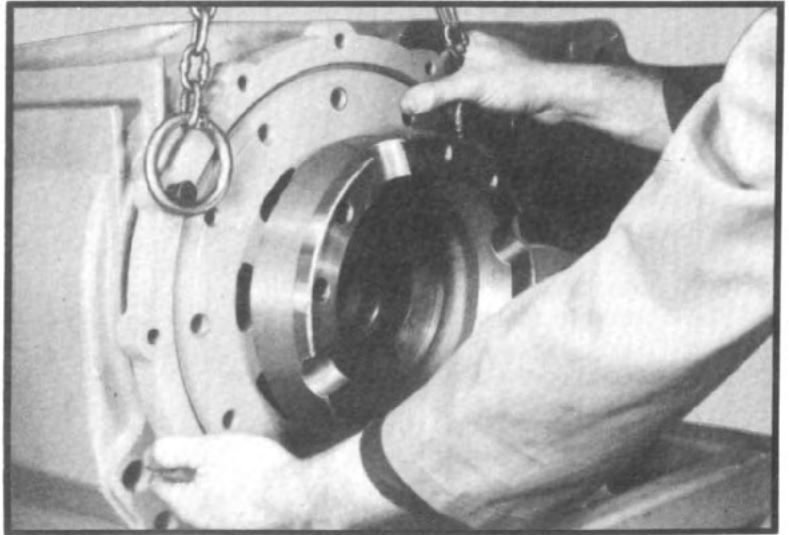

Fig. 52.

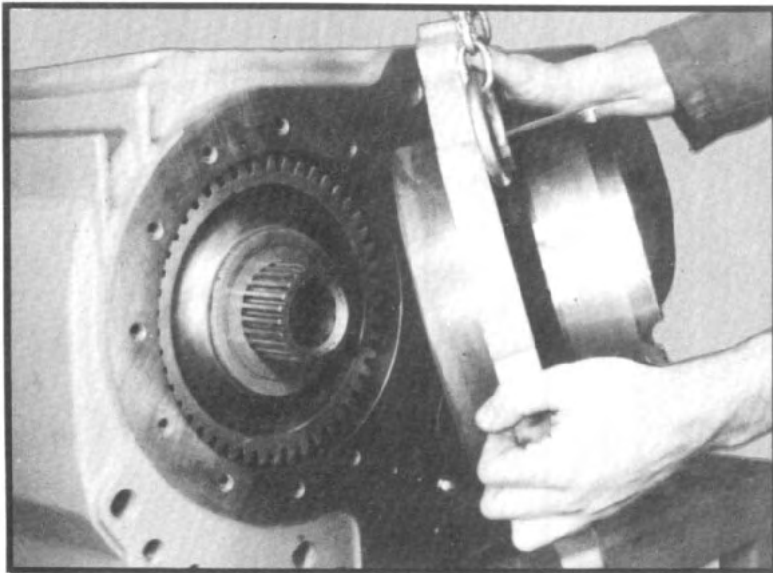

Fig. 53

- 2.18 If rear face plate bearing is to be replaced, drive case half from bearing and remove bearing from face plate.

- 2.19 Remove o-ring from face plate if replacement is necessary.

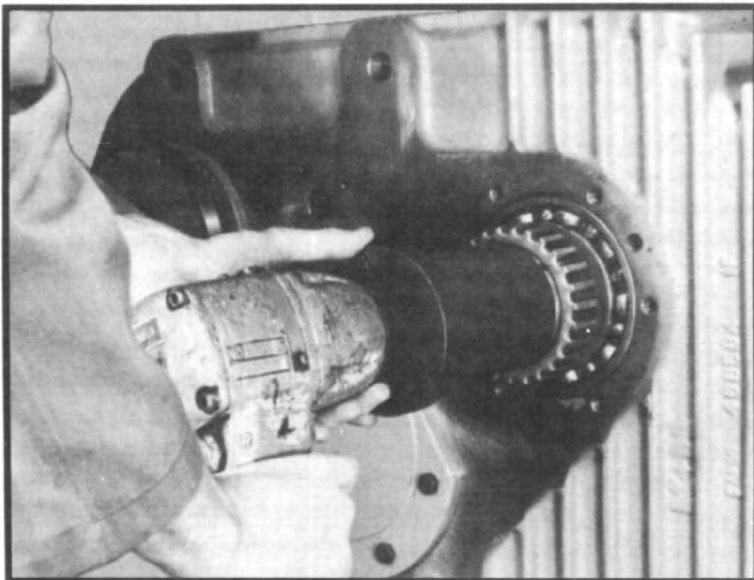

Fig. 54

- 2.20 Remove special nut from inside of clutch gear with special wrench (See tool reference, Section X.) and remove clutch gear from lower shaft. (See fig. 54.)

- 2.21 Remove the thrust washer from the rear of the lower shaft.

V. TRANSFER CASE DISASSEMBLY

- 2.22 Slide direct drive gear from lower shaft through rear case bore (See fig. 55.) and remove gear from shaft. (See fig. 56.) Remove two needle bearing assemblies from shaft or from inside the gear.

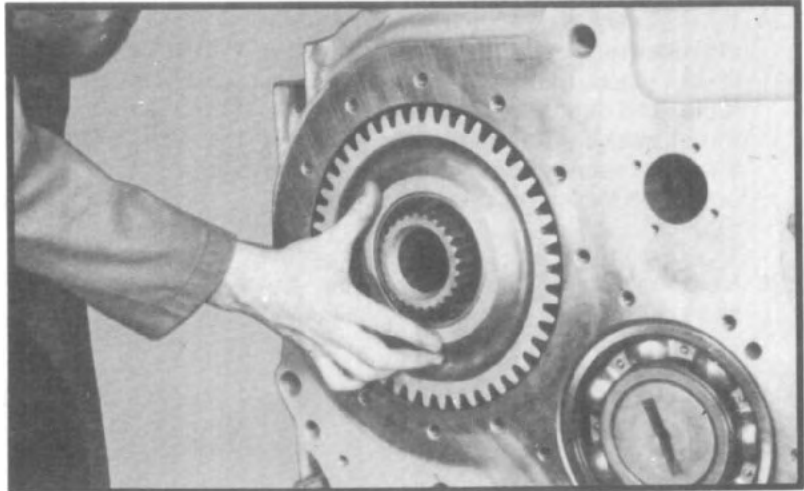

Fig. 55

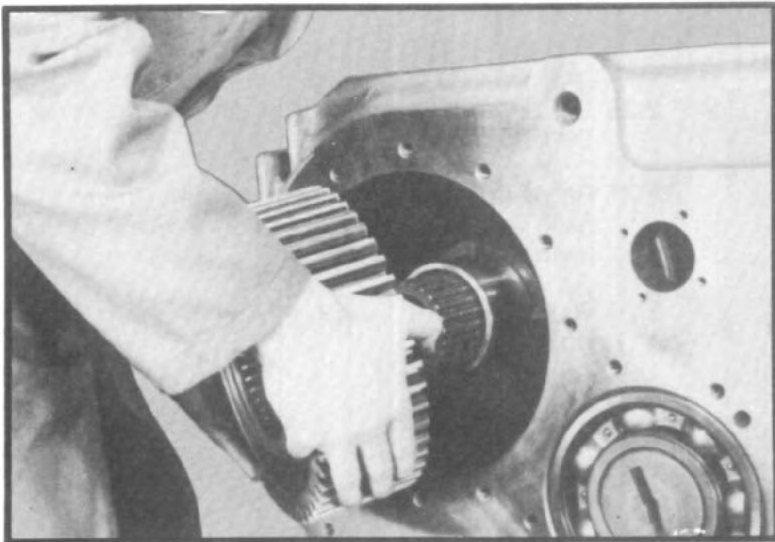

Fig. 56

- 2.23 Place a block of wood between the underdrive gear and inside of housing and drive lower shaft assembly from case by tapping with a mallet on a soft bar located on the front of the shaft. Use care when tapping front of shaft to not damage threads. Withdraw lower shaft from the case. (See fig. 57.) Remove the needle bearing assemblies and spacer ring for the underdrive gear from the shaft or from inside the underdrive gear.

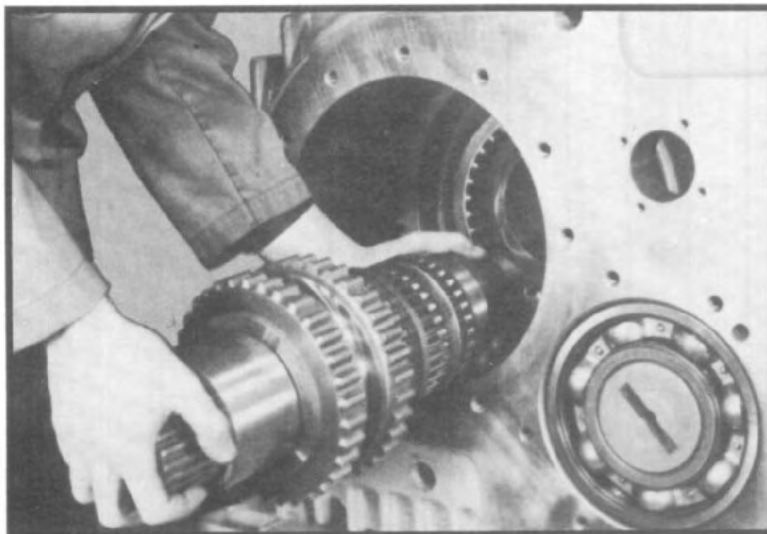

Fig. 57

V. TRANSFER CASE DISASSEMBLY

- 2.24 If necessary to remove the needle bearing inner races and thrust rings from the shaft, place the shaft vertically on a table and tap the clutch gear on the thrust washer. This procedure will push the inner race off the shaft. Repeat this operation for the opposite side. (See fig. 58.)
- 2.25 Remove the clutch collar from the shaft.

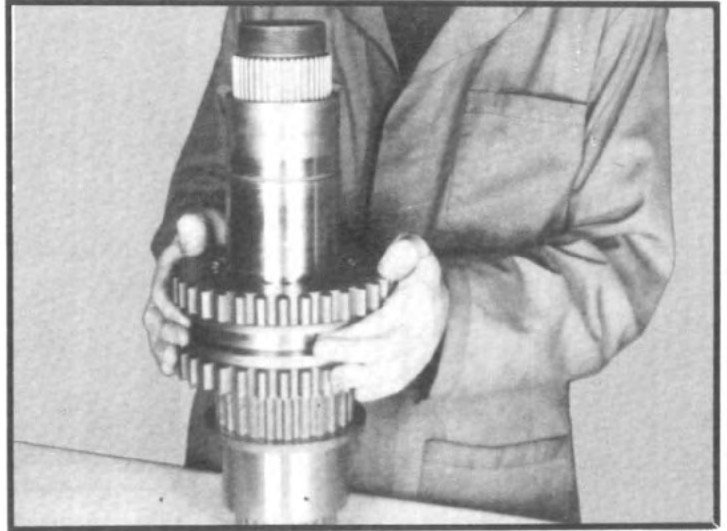

Fig. 58

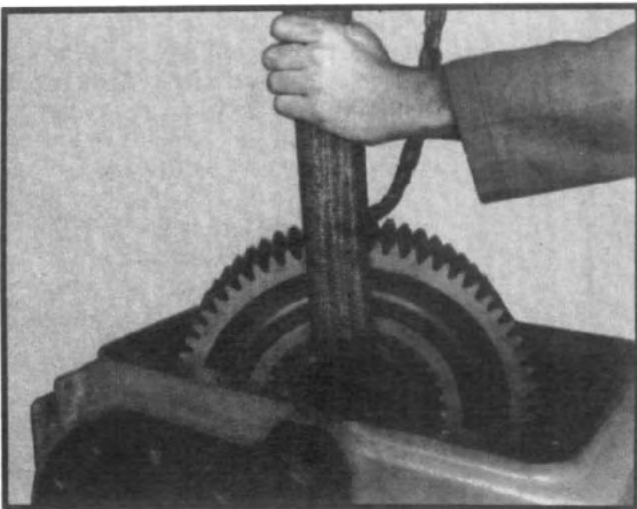

Fig. 59

- 2.26 Lift underdrive gear out of the case. (See fig. 59.)
- 2.27 Retrieve the front thrust washer which will have fallen to bottom case on removal of the lower shaft assembly.
- 2.28 Remove front bearing from transfer case housing.

V. TRANSFER CASE DISASSEMBLY

3.0 Lower Shaft Disassembly With 26/74 Differential

Note: Lockout assembly having been previously removed.

3.1 Remove flange or yoke locknut and washer from rear of shaft, discarding nut, use a new nut for reassembly.

3.2 Slide flange or yoke off rear shaft.

3.3 Unscrew speedometer drive sleeve from rear seal carrier and withdraw speedometer driven gear.

Note: Mark planetary cap, planetary housing and rear face plate before disassembly. Align marks on reassembly.

3.4 Remove 12 long capscrews from planetary cap. (See fig. 60.) Install a bolt or eyebolt to planetary cap through capscrew hole. Using a chain hoist fastened to the bolt or eyebolt, tap the planetary cap until it is free from the planetary housing. Pull cap away from the planetary assembly until it is free from the planetary gears. (See fig. 61.)

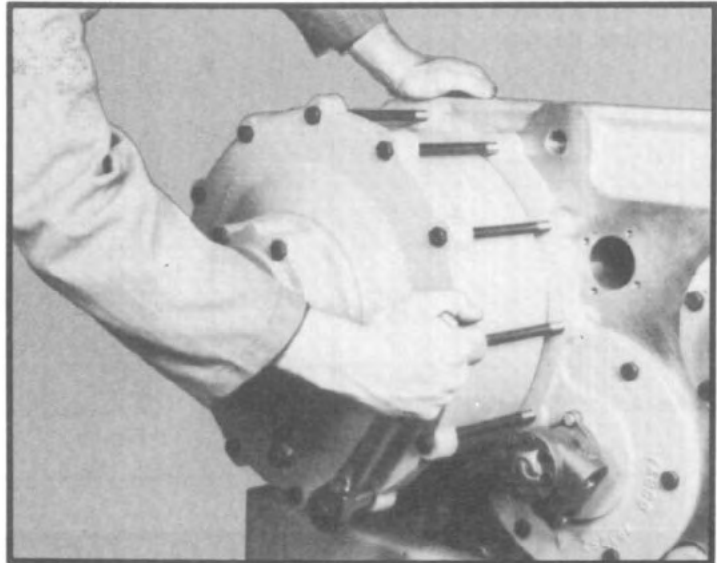

Fig. 60

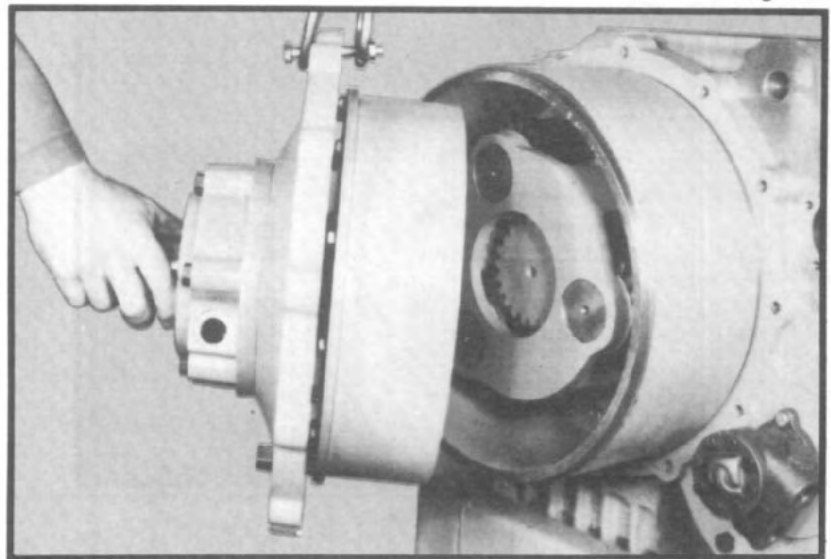

FIG. 61

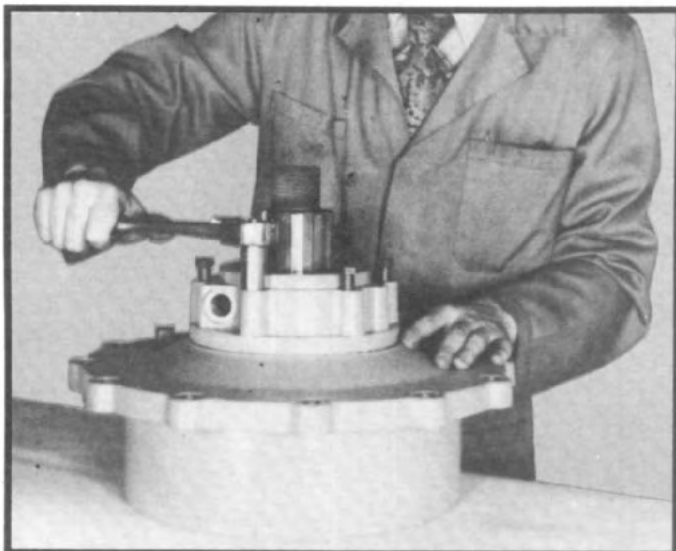

Fig. 62 Gear and Transmission • 906 W. Gore St. Orlando, FL 32805 • 1 (877) 776-4600 / (407) 872-1901

3.5 Remove six capscrews holding seal carrier to planetary carrier cap. Tap seal carrier to loosen and remove. (See fig. 62.) If the seal is to be replaced remove the seal from the seal carrier. Removal procedure will damage the seal and removal should not be attempted unless replacement of the seal is planned.

3.6 Remove speedometer drive gear and spacer from shaft.

3.7 Press rear output shaft — internal gear assembly from planetary cap.

3.8 Press ball bearing from planetary cap. Remove large diameter o-ring if replacement is necessary.

V. TRANSFER CASE DISASSEMBLY

3.9 Tap planetary housing to loosen and remove. (See fig. 63.)

3.10 Remove snap rings from front of three planet pins, located in planet carrier.

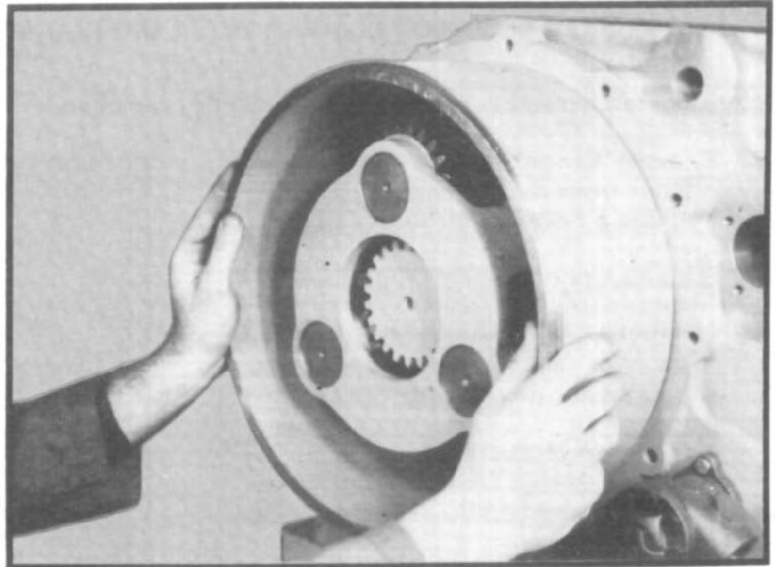

Fig. 63

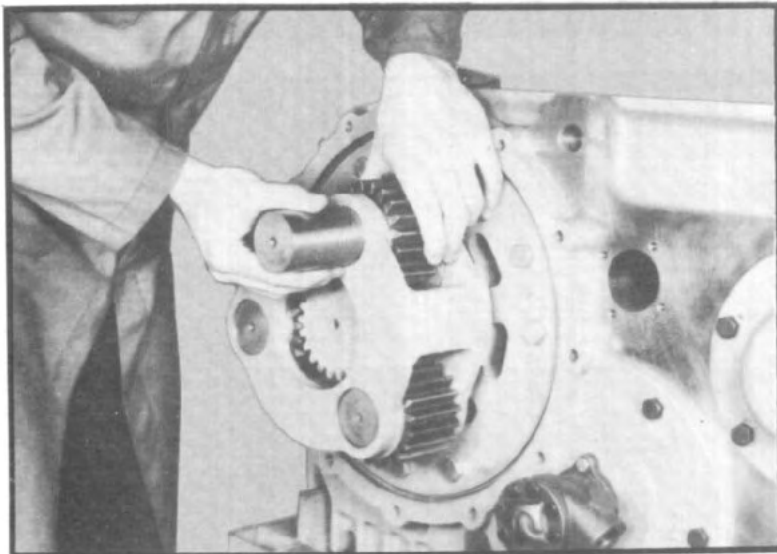

Fig. 64

3.11 Remove a planet pin from the planet carrier and withdraw planet gear and planet pin spacers from planet carrier. Push three needle bearing assemblies and two spacers from planet gear. Repeat procedure for remaining two planet gears. (See fig. 64.)

3.12 Remove retaining ring from front of sun gear shaft and remove shaft. (See fig. 65.) If sun gear requires disassembly remove snap ring and sun gear. Inside retaining ring can be removed if required.

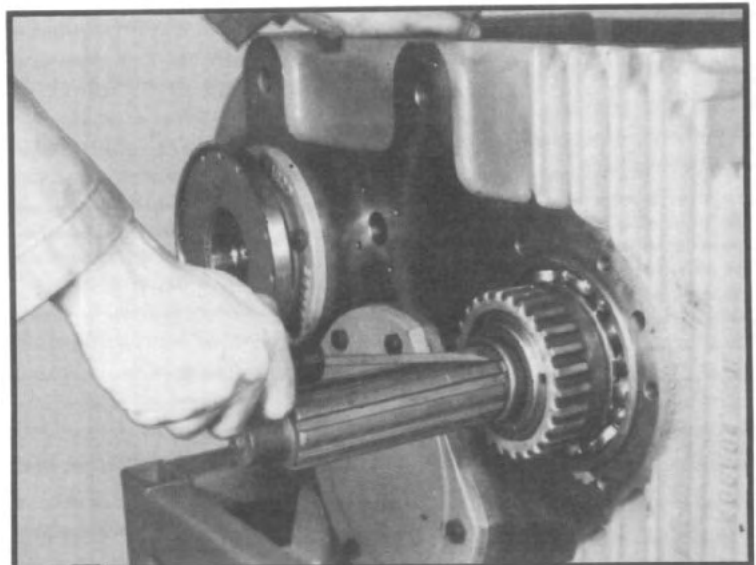

Fig. 65

V. TRANSFER CASE DISASSEMBLY

- 3.13 Remove special nut from inside of planet carrier with a special wrench (See tool reference, Section X and fig. 66.)

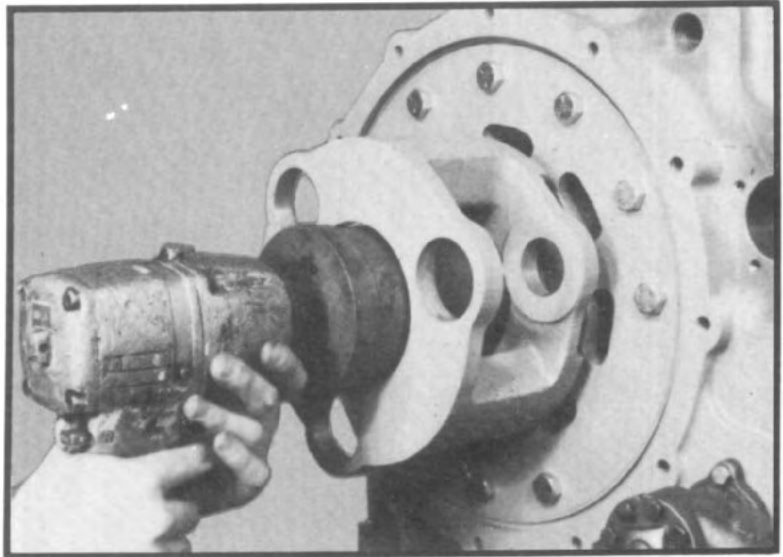

Fig. 66

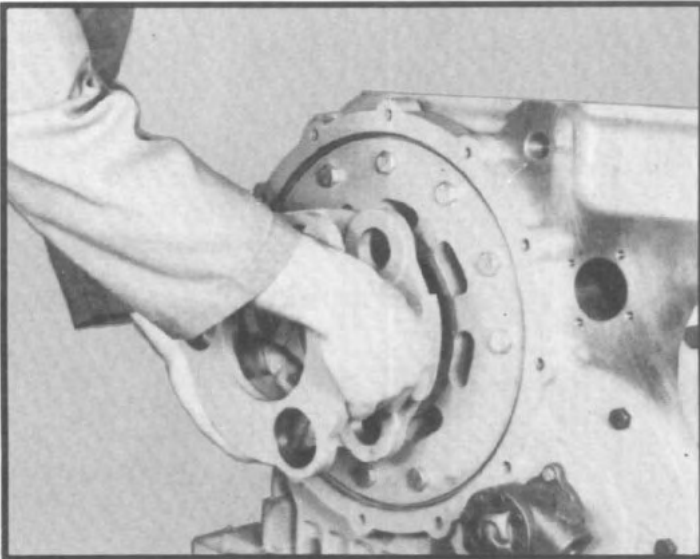

Fig. 67

- 3.14 Remove planet carrier from lower shaft. (See fig. 67.)

- 3.15 Remove three capscrews holding oil pump to rear face plate. (See fig. 68.)

- 3.16 Tap pump lightly to loosen and withdraw pump.

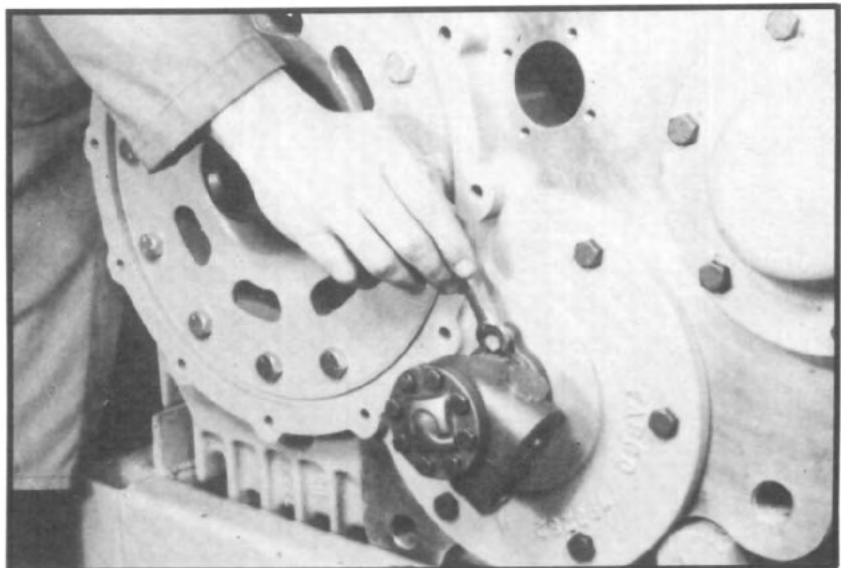

Fig. 68

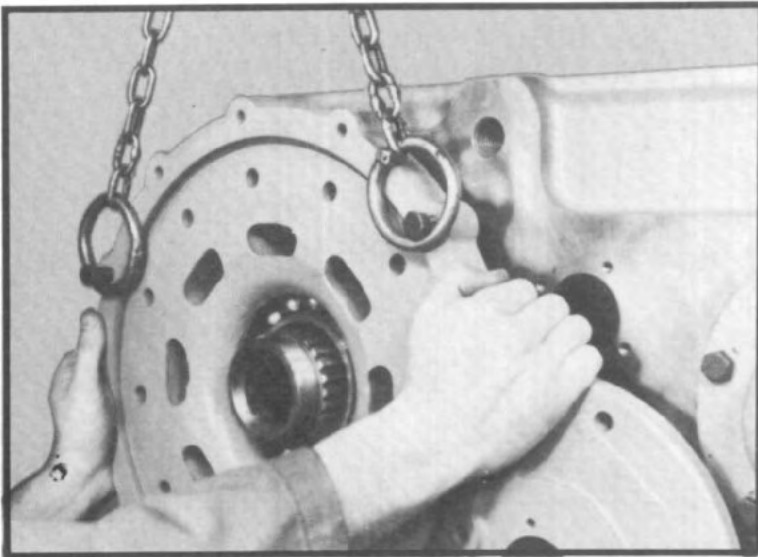

Fig. 69

3.17 Remove fifteen capscrews from rear face plate and remove face plate from housing. It is recommended that two bolts or eyebolts be attached to the face plate and a chain hoist be attached to the bolts or eye bolts with a chain. (See fig. 79.) The face plate can then be worked out of transfer case housing, supported by the chain hoist. (See fig. 70.) Note: As the face plate is being worked out of the transfer case tap the rear of the lower shaft with a soft hammer to remove rear bearing from the face plate.

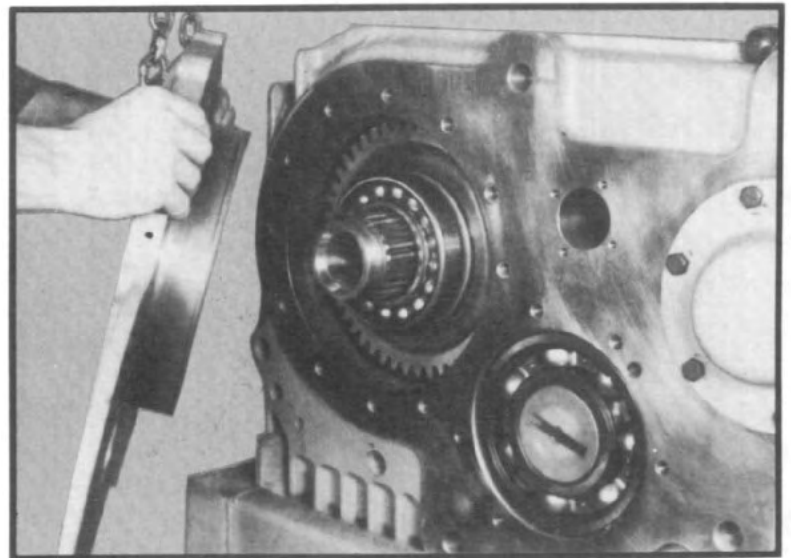

Fig. 70

3.18 Remove o-ring from face plate, if replacement is necessary.

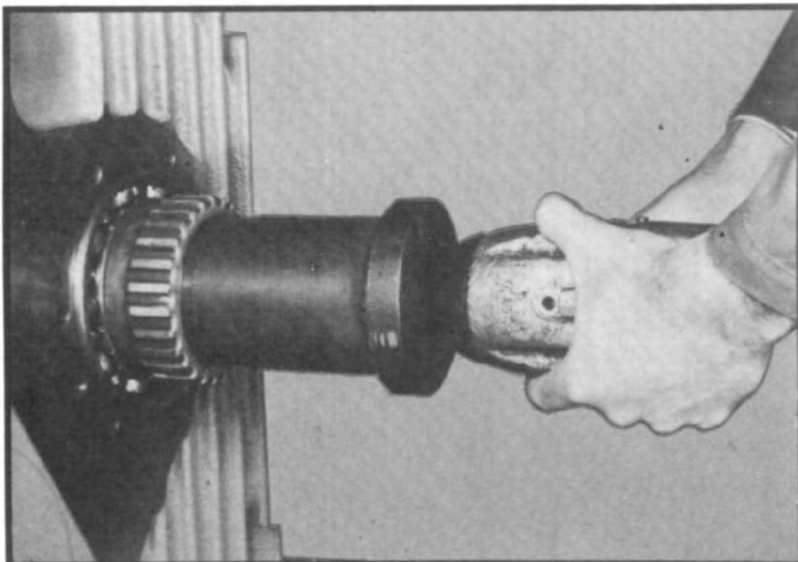

Fig. 71

3.19 Remove special nut from inside of clutch gear with special wrench (See tool reference, Section X and fig. 71.) and remove clutch gear from lower shaft.

3.20 Place a block of wood between the underdrive gear and inside of housing and drive lower shaft assembly from case by tapping with a mallet on a soft bar located on the front of the shaft. Use care when tapping front of shaft to not damage threads. The direct drive gear will have to be aligned with the rear case bore for assembly to be removed. Attach a chain hoist with a sling around the direct drive gear and remove the shaft assembly through the rear case bore. (See fig. 72.) Remove the needle bearing assemblies and spacer ring for the underdrive gear from the shaft or from inside the underdrive gear.

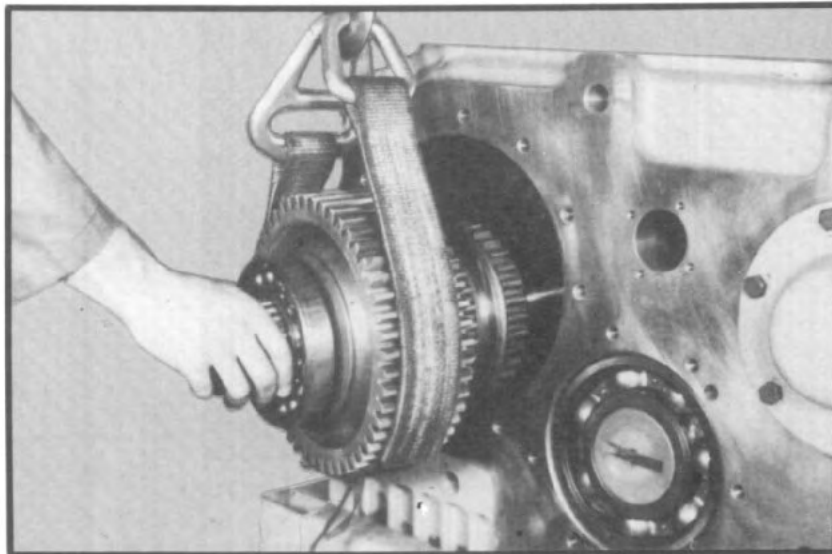

Fig. 72

Fig. 35

3.21 Disassemble the shaft assembly by placing the front of the shaft on a block of wood for support. Tap with a soft hammer on the rear of the shaft, pushing the shaft through the direct drive gear and pushing the rear bearing and thrust washer from the shaft. (See fig. 73.)

3.22 When the rear bearing and thrust washer have been removed, remove the direct drive gear from the shaft. Remove needle bearing assemblies from inside the gear or from the shaft.

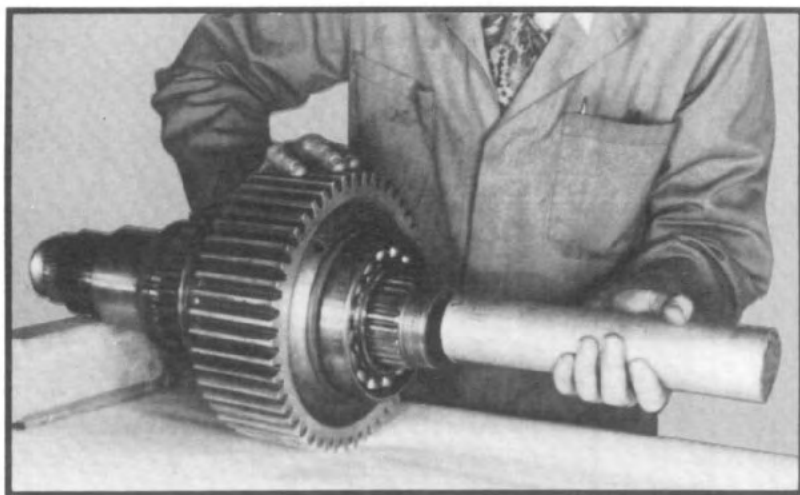

Fig. 73

3.23 If necessary to remove the needle bearing inner races and thrust rings from the shaft, place the shaft vertically on a table and tap the clutch gear on the thrust washer. This procedure will push the inner race off the shaft. Repeat this operation for the opposite side. (See fig. 74.)

3.24 Remove the clutch collar from the shaft.



Fig. 74

V. TRANSFER CASE DISASSEMBLY

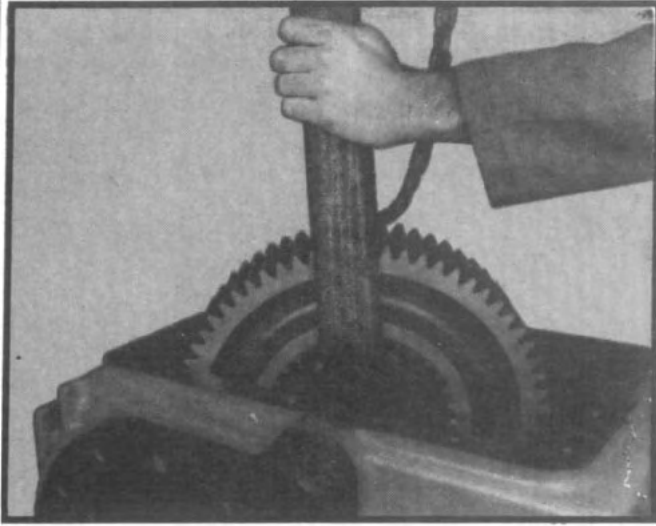

Fig. 75

- 3.25 Lift underdrive gear out of the case. (See fig. 75.)
- 3.26 Retrieve the front thrust washer which will have fallen to bottom case on removal of the lower shaft assembly.

H. Intermediate Shaft Disassembly

1. Remove three capscrews holding oil pump to rear bearing cap. (See fig. 76.)
2. Tap pump lightly to break loose, and withdraw pump.

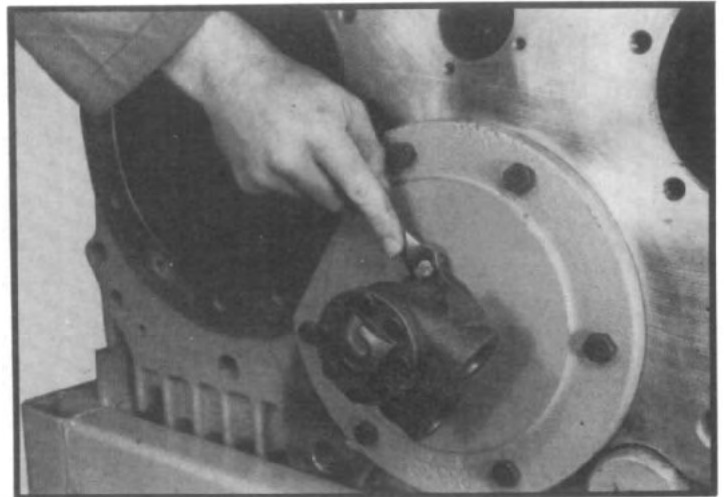

Fig. 76

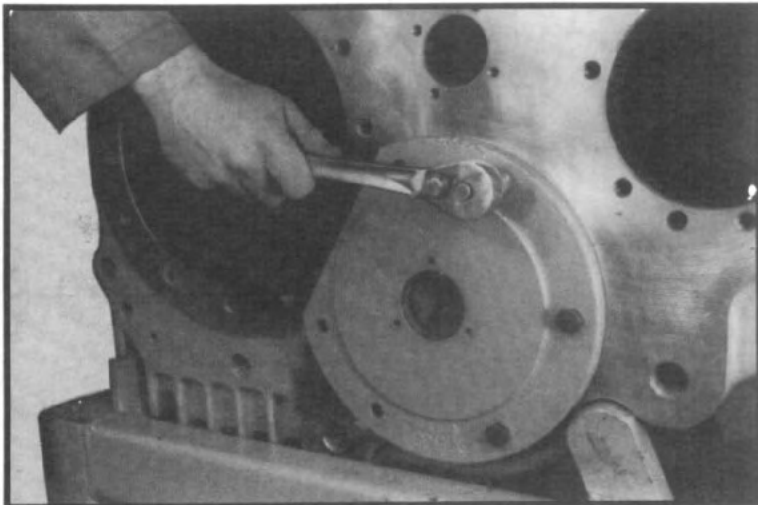

Fig. 77

3. Remove six capscrews each from rear and front bearing caps, tap caps lightly to break loose and remove caps. (See fig. 77.)

V. TRANSFER CASE DISASSEMBLY

H. Intermediate Shaft Disassembly

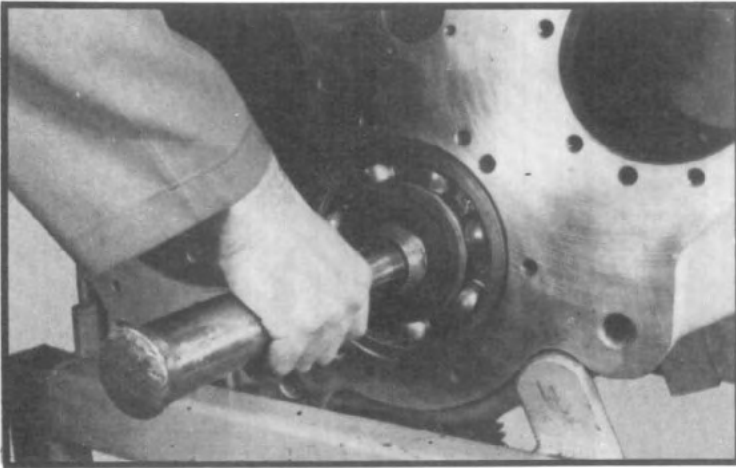

Fig. 78

4. Place a block of wood between the direct drive gear and inside of housing and drive out the intermediate shaft including the front bearing, using a suitable driver on the rear of the shaft. (See fig. 78.)

5. Withdraw intermediate shaft and intermediate shaft underdrive gear as a unit through front bearing bore. Use care to prevent damage to direct drive gear as shaft pulls free. (See fig. 79.)
6. Remove direct drive gear from case.
7. Retrieve the spacer ring (located between the direct drive gear and rear bearing) which will have fallen to the bottom of the case on removal of intermediate shaft.
8. Tap out rear bearing from housing using a suitable driver.
9. Tap or press intermediate shaft through front bearing and underdrive gear. (See fig. 80.)

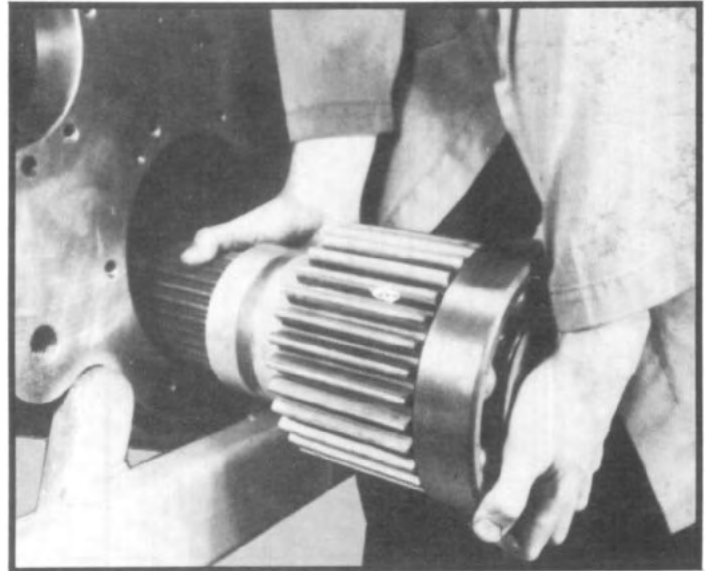
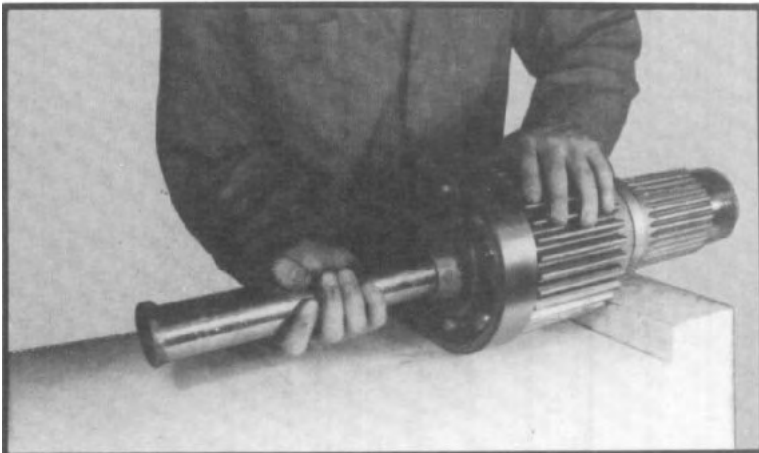

Fig. 79



V. TRANSFER CASE DISASSEMBLY

I. Oil Pump Disassembly

1. Place pump in a vise, shaft facing up, so that one jaw grips across the two ports. Use care to avoid distorting pump housing by excessive tightening of vise.
2. Remove any burrs on shaft drive tang.
3. Remove housing plug with a suitable spanner wrench.
4. Remove from vise and punch match marks on cover and body for reassembly.
5. Remove capscrews, cover, idler and rotor from housing.
6. Check pump, housing, rotor, idler gear, idler pin and crescent for wear, chipped or broken teeth.
7. Housing bore and rotor O.D. may be checked for wear by positioning rotor in the housing and check for clearance in the bearing. The shaft must turn freely without any detectable side play. Any side play will require replacement of the housing, rotor or both. If both housing and rotor require replacing, it is economically advisable to replace the pump.

VI. CLEANING & INSPECTION

A. Choice of Cleaning Methods

1. Steam may be used for external cleaning of completely assembled units. Care must be taken to ensure that water is kept out of the assembly by tightly closing breather caps and other openings.
2. Rough parts such as housings, which are too large to conveniently clean with solvents, may be immersed in hot solution tank containing a mild alkaline solution. Parts cleaned in hot solution tanks must be rinsed thoroughly to prevent damage by traces of alkaline material.
3. Parts with ground or polished surfaces, such as bearings, gears, and shafts, should be cleaned with emulsion cleaners or petroleum solvents. Alkaline hot solution tanks may damage the machined surfaces, and such cleaning methods should be avoided.

B. Drying And Corrosion Inhibition

Soft, clean shop towels should be used to dry parts after cleaning. Compressed air may be used to clean inaccessible areas of large parts such as housing. Bearings should not be spun dry with compressed air, as the lack of lubrication may cause damage to the mating surfaces.

Dried parts should be immediately coated with a light oil or corrosion inhibitor to prevent corrosion damage. Parts which are to be stored should also be wrapped in heavy waxed paper.

C. Inspection

Prior to reassembly, parts which are to be reused must be carefully inspected for signs of wear or damage. Replacement of such parts can prevent costly downtime at a future date.

All bearing surfaces, including ball bearing assemblies and roller bearing cups and cones, should be examined for pitting, wear, or overheating. Gears also may show pits, as well as scoring and broken teeth. Shafts may be nicked and marred, or may have damaged threads. Parts which show any signs of damage should be repaired or replaced.

VII. TRANSFER CASE ASSEMBLY

A. General Precautions For Reassembly

IMPORTANT: READ THIS SECTION BEFORE STARTING THE REASSEMBLY PROCEDURES.

Make sure that interior of transfer case is clean. It is important that dirt be kept out of transfer case during reassembly. Dirt is abrasive and can damage polished surfaces of bearings and washers. Use certain precautions, as listed below, during reassembly.

1. Gaskets — Use new gaskets throughout the transfer case as it is being rebuilt. Make sure all gaskets are installed, as omission of gasket can result in oil leakage.
2. Capscrews — To prevent oil leakage, use permatex form-a-gasket #2 pliable setting sealant or equal on all threads. See torque rating chart for recommended torque, Section VIII.
3. Assembly — Refer to the illustrations and part list (located in Section IX) as a guide to reassembly.
4. Initial Lubrication — Coat all thrust washers, splines and seals with lubriplate during installation to provide initial lubrication, preventing scoring and galling.
5. Bearings — Use of flanged-end bearing drivers is recommended for the installation of bearings. These drivers apply force to either race of a bearing, whichever is being installed, preventing damage to balls and races and maintaining correct bearing alignment with shaft and bore.
6. Universal Joint Companion Flanges — Pull the companion flanges tightly into place with the stop nuts, tightening to proper torque. Failure to pull the yoke or flange tightly into place will permit the shaft to move axially with resultant damage to rear bearing.

B. Intermediate Shaft Assembly

Note: If transfer case is equipped with a proportioning differential, omit steps 9 and 10.

1. Install the rear roller bearing into the transfer case housing until it is flush with outside surface of the housing.
2. Position intermediate shaft direct drive gear in housing. (49 Tooth Gear.)
3. Place two identical spacer rings over intermediate shaft. (Inside diameter chamfer facing the center of the shaft.) (See fig. 81.)

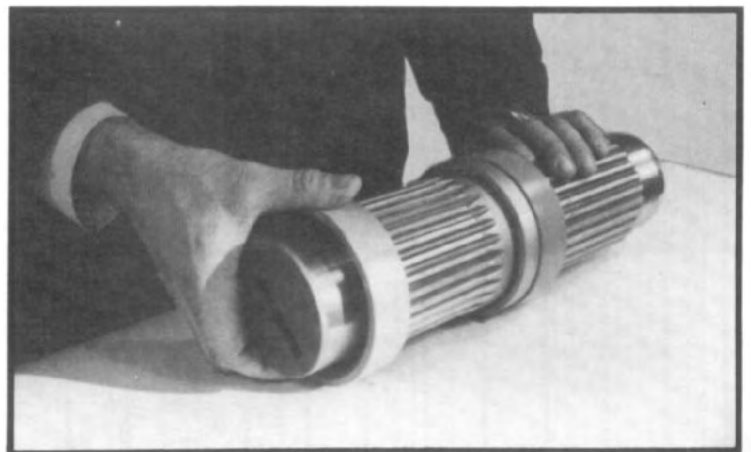

Fig. 81

VII. TRANSFER CASE ASSEMBLY

- Slide underdrive gear onto intermediate shaft. (See fig. 82.)

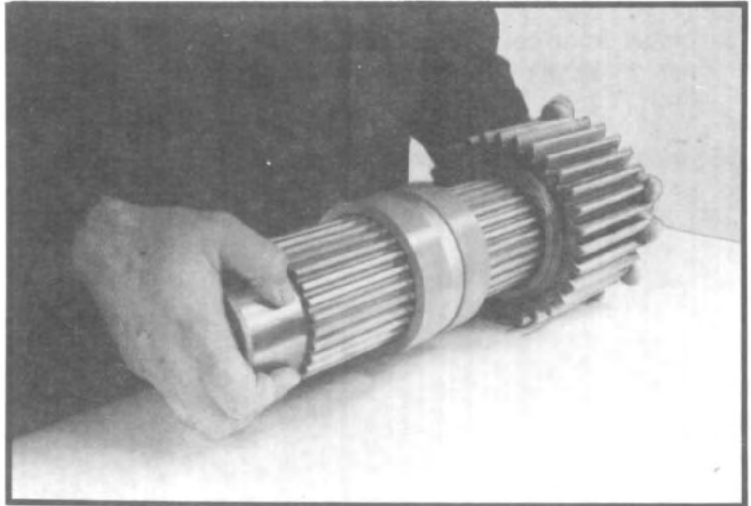

Fig. 82

- Install special tool over the rear bearing and bolt to housing. (See Tool Reference, Section X and fig. 83.)

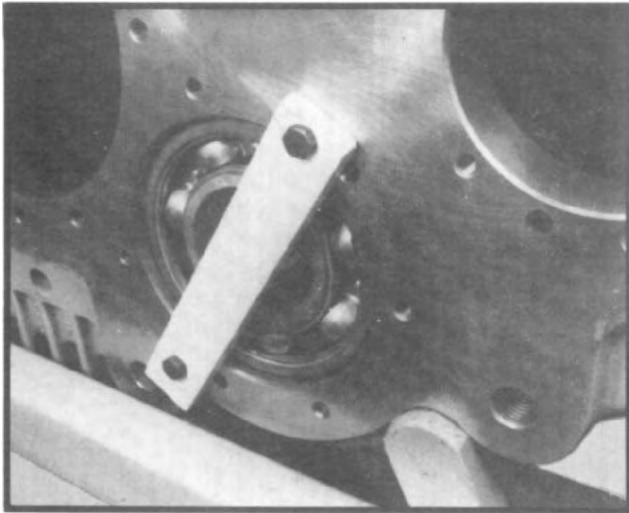

Fig. 83

- Insert intermediate shaft through front bearing bore and through direct drive gear. (See fig. 84.) Place the spacer ring over the rear of the shaft and against the gear. Tap the front of the shaft into rear bearing.

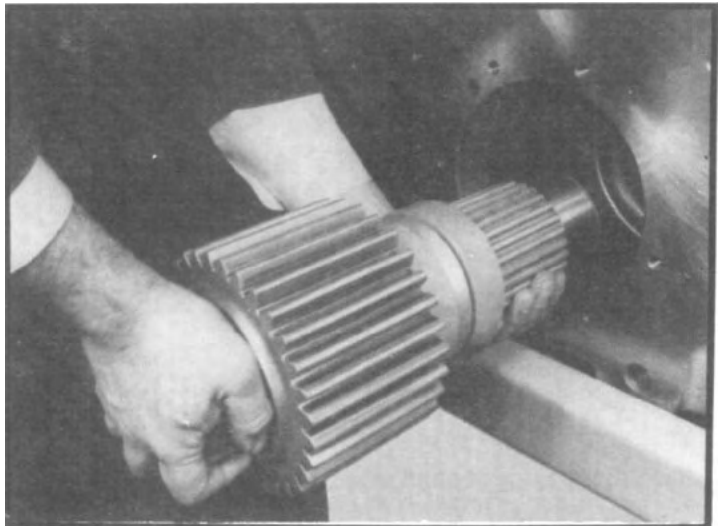

Fig. 84

- Install front bearing over end of shaft. Remove special tool from rear of case. (See fig. 85.)



Pro Gear and Transmission • 906 W. Gore St. Orlando, FL 32805 • 1 (877) 776-4600 / (407) 872-1901
Fig. 85

VII. TRANSFER CASE ASSEMBLY

8. Install front cover plate and gasket using the six capscrews. (See fig. 86.)
9. Install rear cover plate and gasket using the six capscrews.

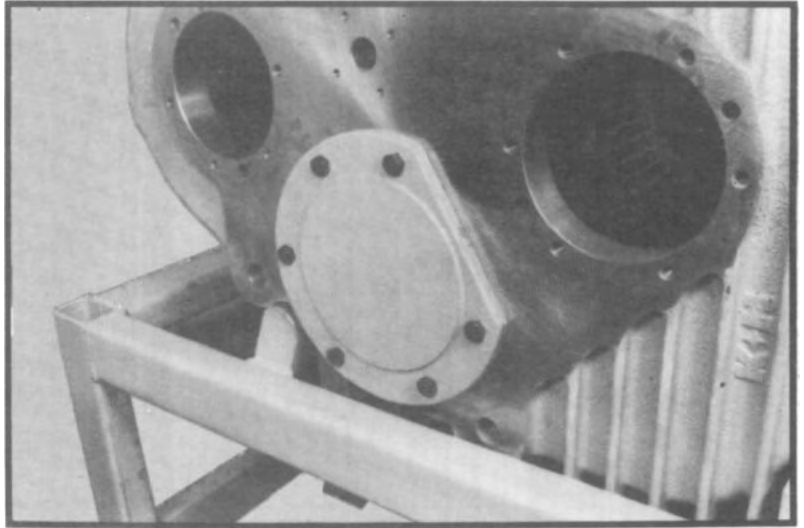

Fig. 86

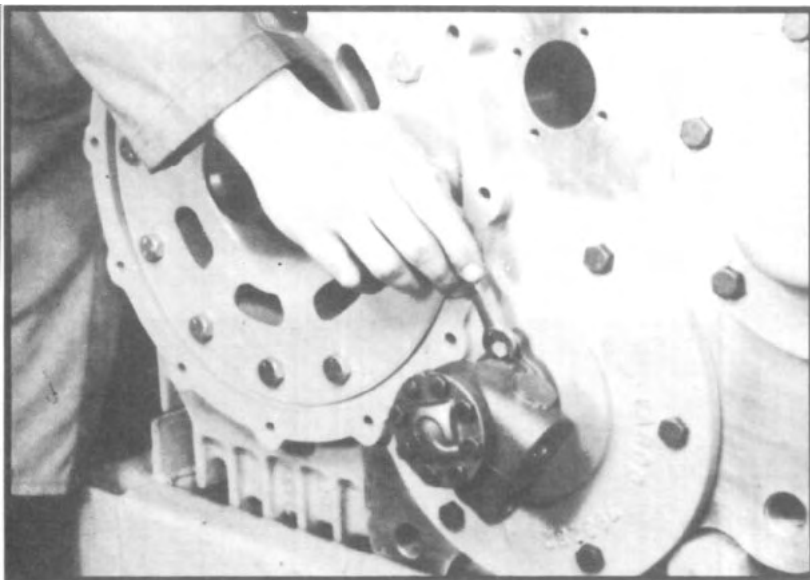

Fig. 87

10. Install oil pump (with ports facing down and towards the top of the case, See fig. 87) and gasket to rear cover plate using three capscrews. Tighten capscrews to correct torque. Check location of pump by turning shaft to ensure pump is freely turning. If pump has been disassembled, consult Section VII-I.

C. Upper Shaft Assembly

1. Position upper shaft input gear in housing. (48 Tooth Gear) (See fig. 88.)

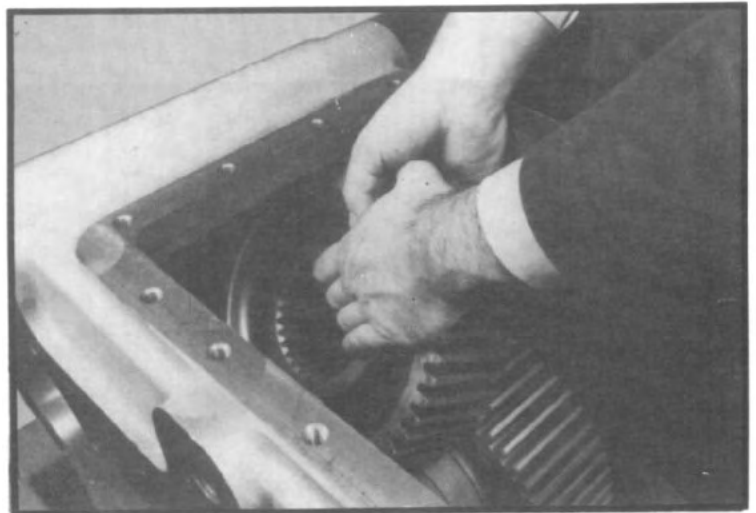

Fig. 88

2. Place the spacer ring over the large spline of the shaft and against the shoulder of the shaft with the inside chamfer facing toward center of shaft. (See fig. 89.)
3. Insert the upper shaft through front bearing bore and slide the shaft through the input gear.

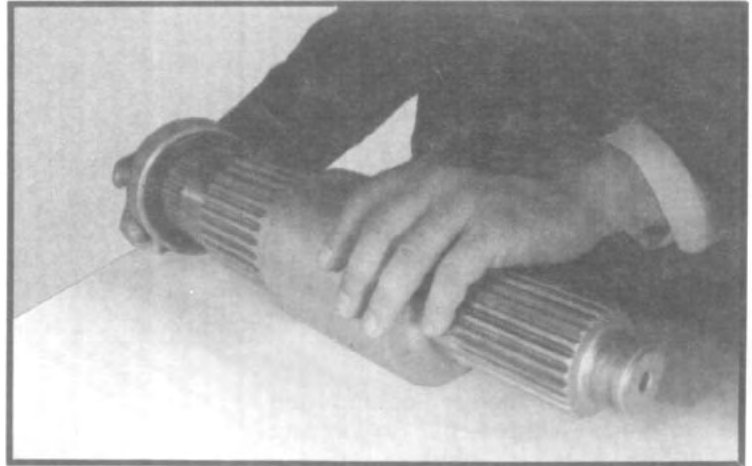

Fig. 89

4. Supporting the upper shaft, place the spacer tube over the shaft through the front bearing bore. (See fig. 90.)

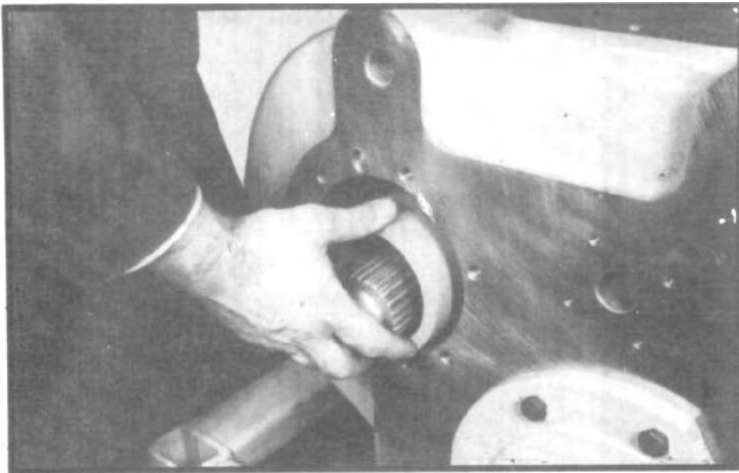

Fig. 90

5. Tap the front ball bearing into the housing using a suitable driver. (See VII-A-5 and fig. 91.)
6. Press the flange seal into the seal carrier with a suitable driver.

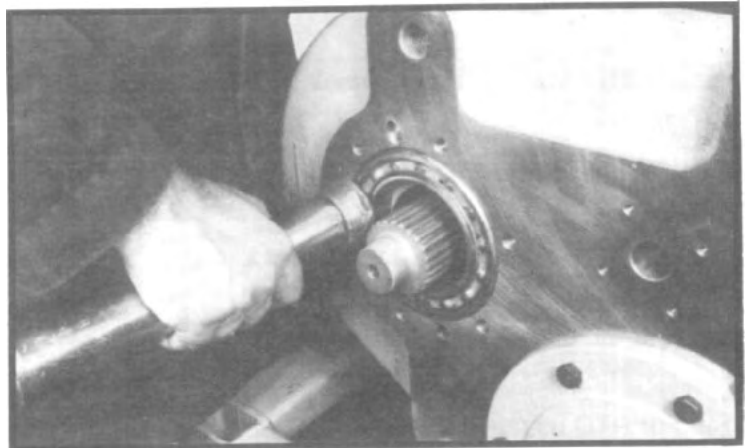

Fig. 91

7. Install front seal carrier and gasket to housing using the six capscrews. Be sure to align oil passages. Tighten capscrews to correct torque. (See fig. 92.)



Fig. 92

VII. TRANSFER CASE ASSEMBLY

8. Install the input flange through the seal and onto the shaft, coating the flange lightly with gear lubricant will reduce the chance of damaging the seal.
9. Install spacer ring over the rear of the shaft.
10. Install the upper shaft rear ball bearing into the housing with a suitable driver. (See fig. 93.)
11. Install input flange locknut and washer. Tighten nut to correct torque.

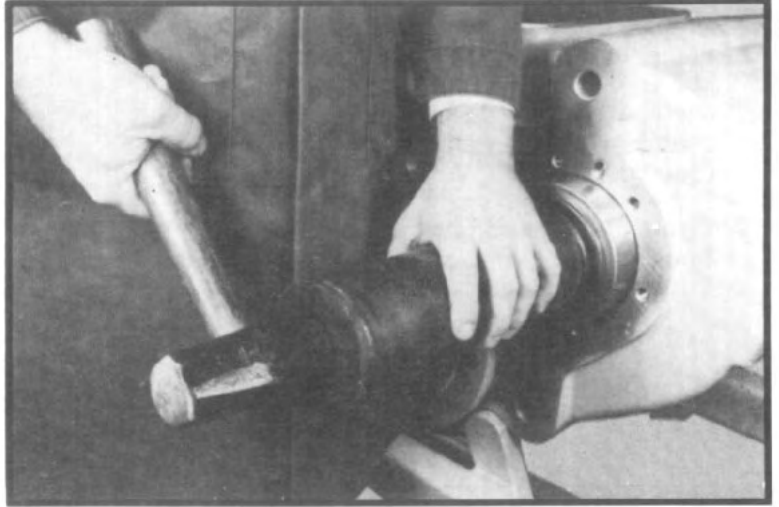

Fig. 93

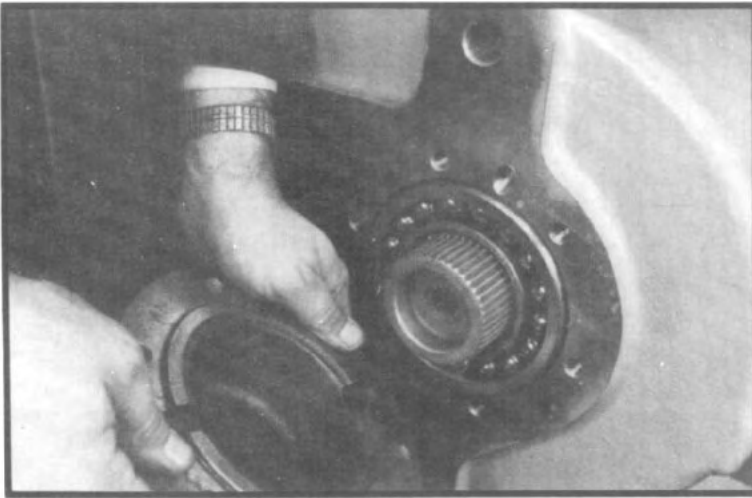

Fig. 94

If transfer case is not equipped with PTO:

12. Install rear cap and gasket to housing using the six capscrews. Be sure to align oil passages. Tighten capscrews to correct torque. (See fig. 94.)

If transfer case is equipped with a PTO:

13. Install the spacer washer, declutch gear and special washer onto the rear of the shaft with the locking capscrew. (See fig. 95.)
14. For PTO assembly refer to Section VII-F.

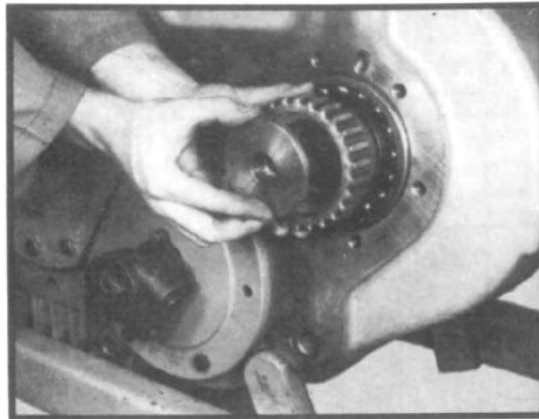

Fig. 95

VII. TRANSFER CASE ASSEMBLY

D. Lower Shaft Assembly

1.0 Lower Shaft Assembly With Standard Case

1.1 Install clutch collar on shaft.

1.2 Place the two identical thrust washers over the shaft and against the outside faces of the clutch gear splines. Oil groove side of washer to face outwards and toward the drive gear. (See fig. 96)

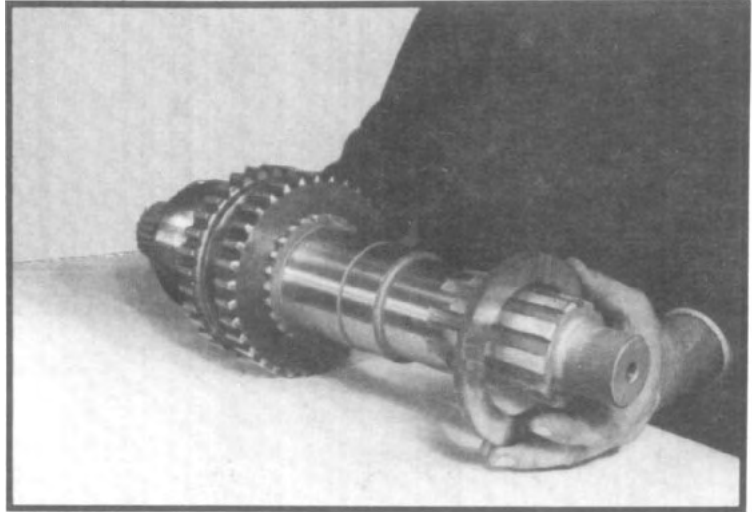
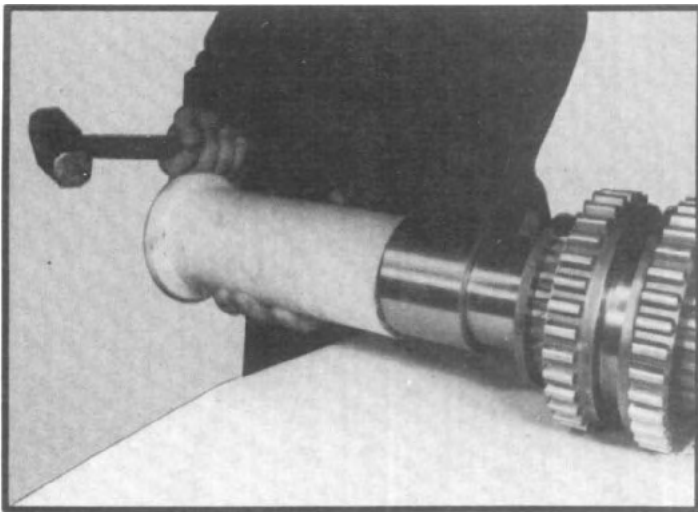

Fig. 96



1.3 Tap the needle bearing inner races over each end of shaft with a suitable driver. The wider inner race is located on the front side of the shaft and the shorter race is located on the rear side. (The needle bearing inner race must be snug against the thrust washer.) (See fig. 97.)

Fig. 97

1.4 Slide the two needle bearing assemblies and spacer ring over the front of the shaft. The wider bearing, first; spacer ring, second and narrower needle bearing, last. (See fig. 98.)

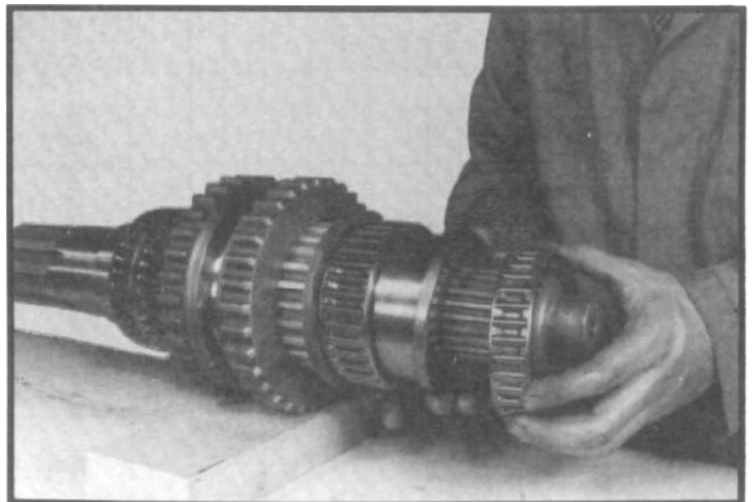

Fig. 98

VII. TRANSFER CASE ASSEMBLY

- 1.5. Place underdrive gear in housing with clutch face inward. (See fig. 99)

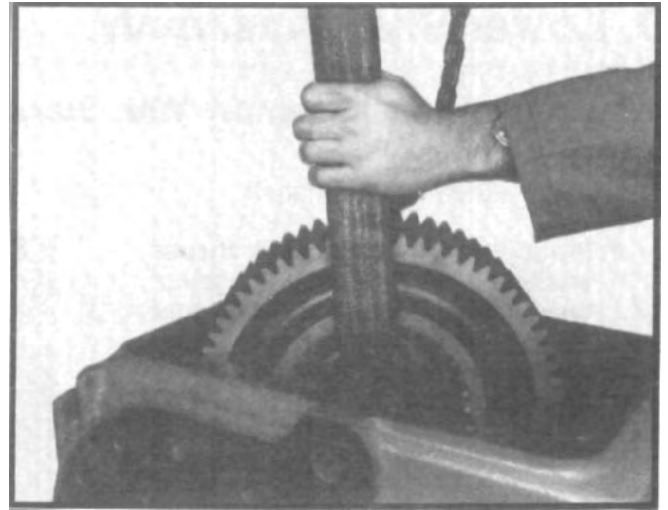

Fig. 99

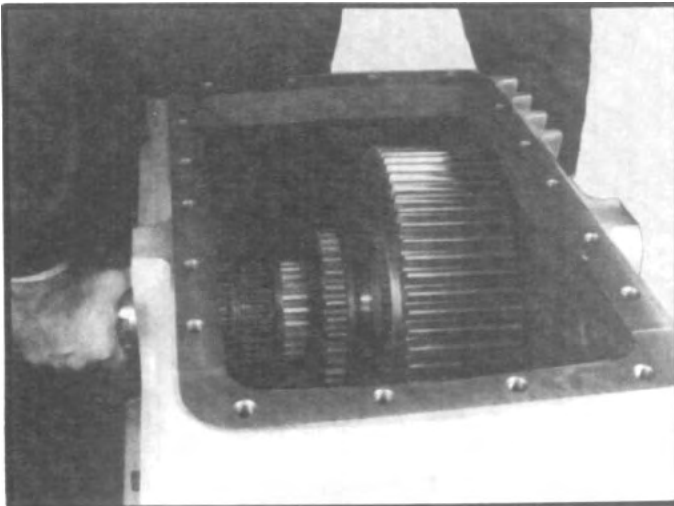

Fig. 100

- 1.6. Install lower shaft assembly into housing through rear bore. (See fig. 100) Insert shaft assembly into underdrive gear. As shaft assembly enters the front bore, place the thrust washer over front of shaft and against underdrive gear. (See fig. 101) Place flat side of thrust washer against the gear.

- 1.7. Press the lower shaft front bearing on the clutch gear.

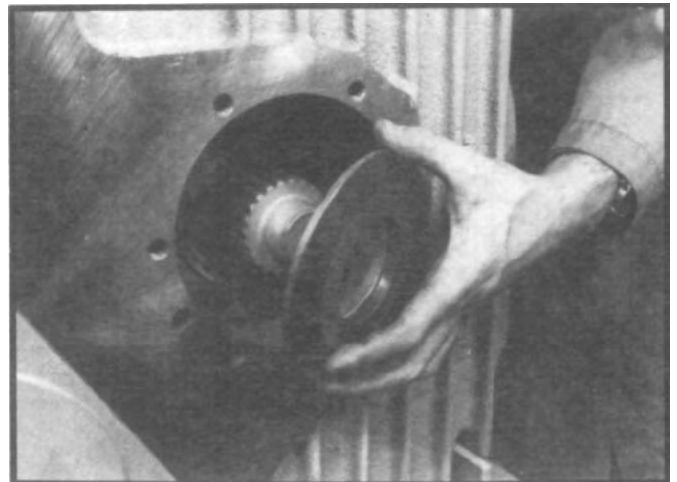

Fig. 101

VII. TRANSFER CASE ASSEMBLY

- 1.8. Install clutch gear and bearing assembly on front of shaft. (See fig. 102) Supporting the shaft assembly with a chain hoist, (See fig. 103) tap the clutch gear with a soft hammer to push the bearing into the housing. (See fig. 104) Assemble the nut and washer on the end of the shaft, finger tight. Do not remove the chain hoist support until after Step 10.

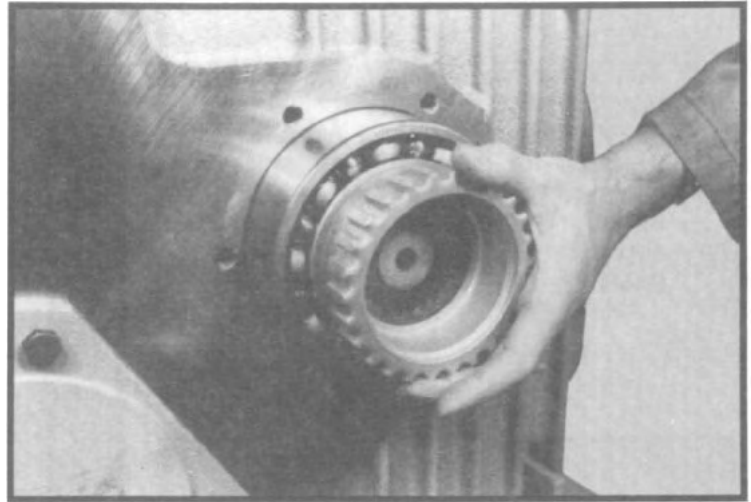

Fig. 102

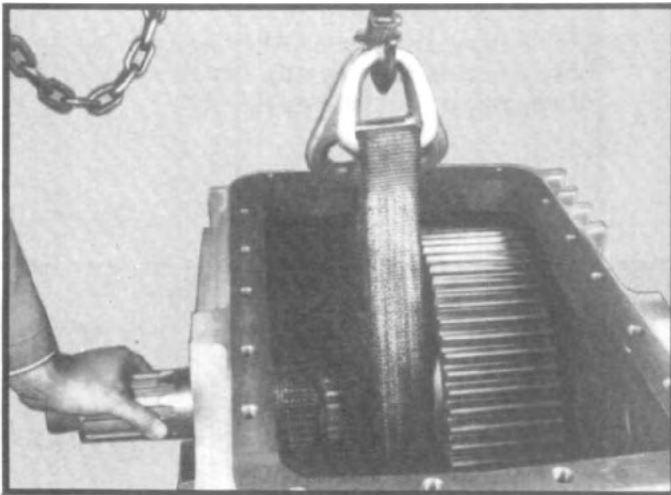

Fig. 103

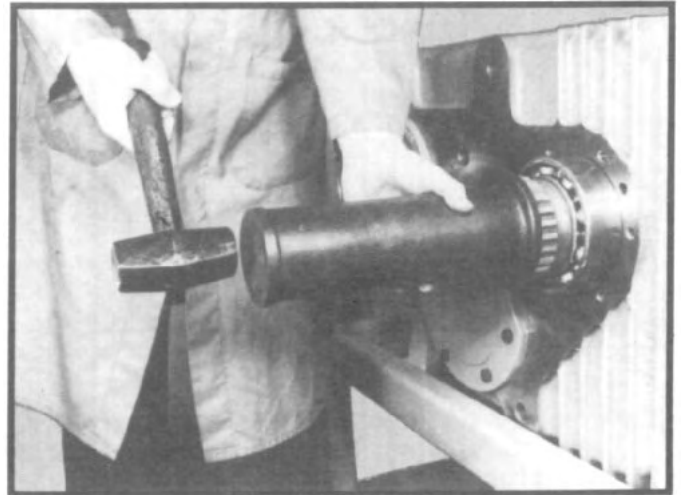

Fig. 104

- 1.9 Slide the two needle bearing assemblies over the rear of the shaft. The wider needle bearing, first and the narrower needle bearing, last.
- 1.10 Install the direct drive gear through the rear case bore and onto rear of shaft with clutch face inwards. (See fig. 105) Remove chain hoist support from shaft assembly.
- 1.11. Place thrust washer over rear of shaft and against the gear. Place flat side of washer against the gear.

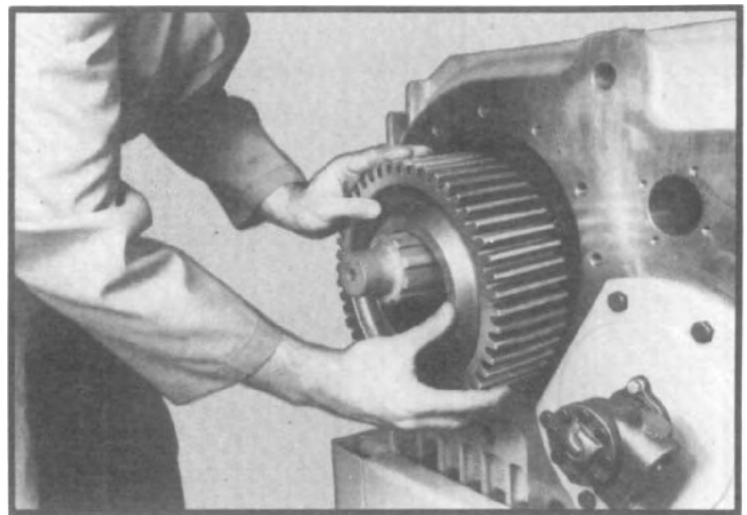

Fig. 105

VII. TRANSFER CASE ASSEMBLY

- 1.12 Tap lower shaft rear roller bearing over the shaft and snug against the thrust washer with a suitable driver. (See fig. 106.) With a feeler gauge, measure the end play between gear ends and thrust washers. There should be .015-.020 end play on both gears.

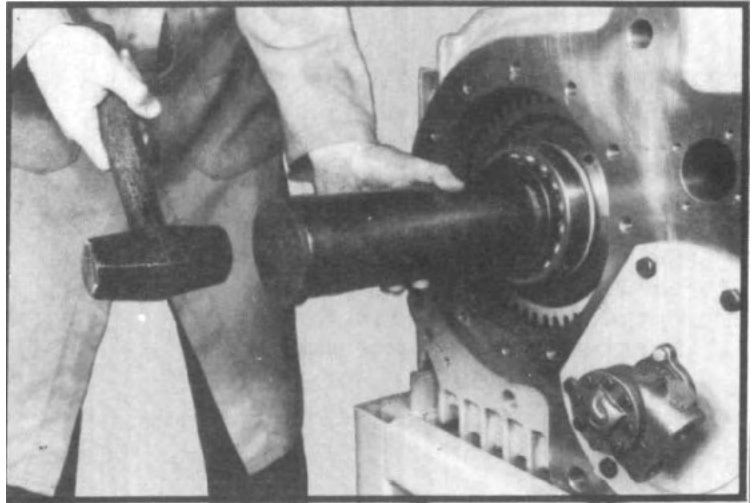

Fig. 106

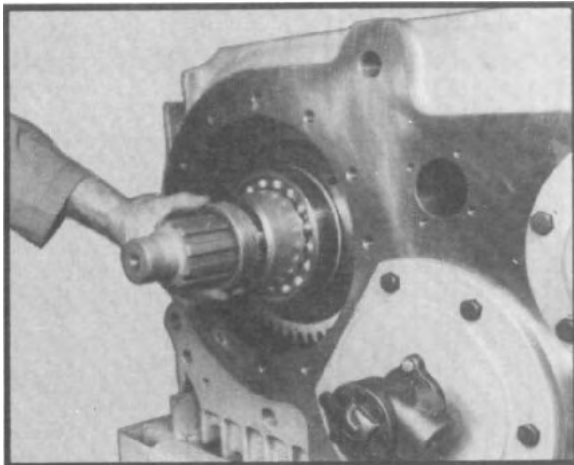

Fig. 107

- 1.14. Install rear output carrier and gasket to housing. Move the lower shaft up or down until the bearing seats into the carrier. Tap the carrier with a soft bar until the carrier is against the housing. (See fig. 108)

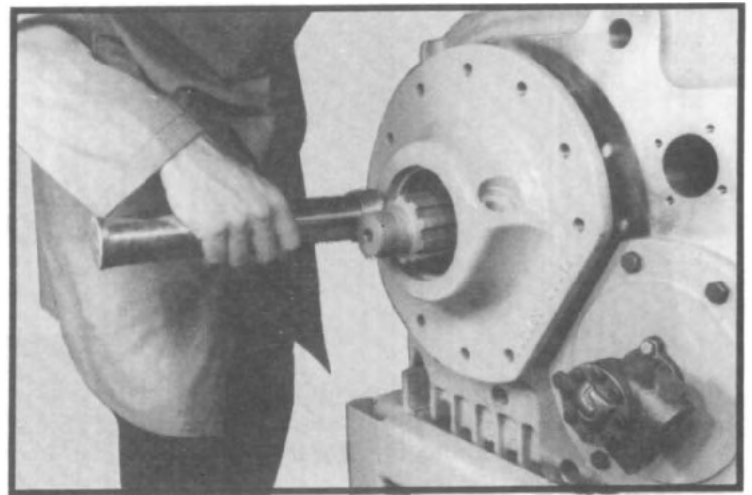

Fig. 108

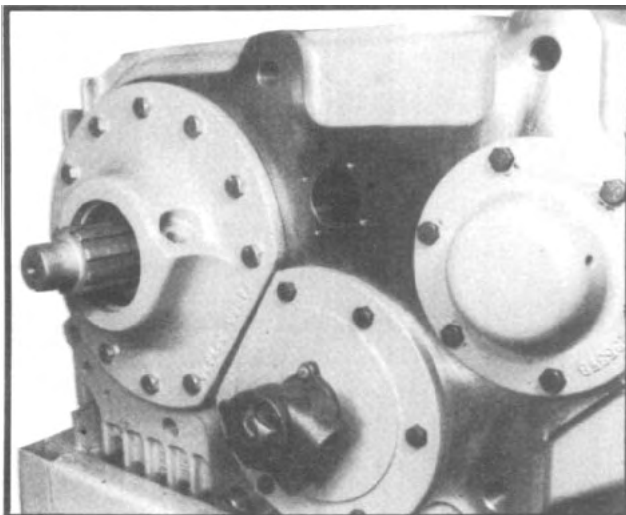

Fig. 109

- 1.15. Bolt rear output carrier to housing with the eleven capscrews. Tighten to correct torque. (See fig. 109)
- 1.16. Tap rear output seal into place using a suitable driver.

VII. TRANSFER CASE ASSEMBLY

- 1.17 Install speedometer driven gear to mesh correctly with drive gear. (See fig. 110.)
- 1.18 Install speedometer sleeve, tightening securely.
- 1.19 Tighten front output clutch gear nut to correct torque.
- 1.20 Coat the hub of the output flange or yoke with gear lubricant and slide the flange or yoke onto rear output shaft.
- 1.21 Assemble washer and locknut to rear of output shaft. Tighten locknut to correct torque.

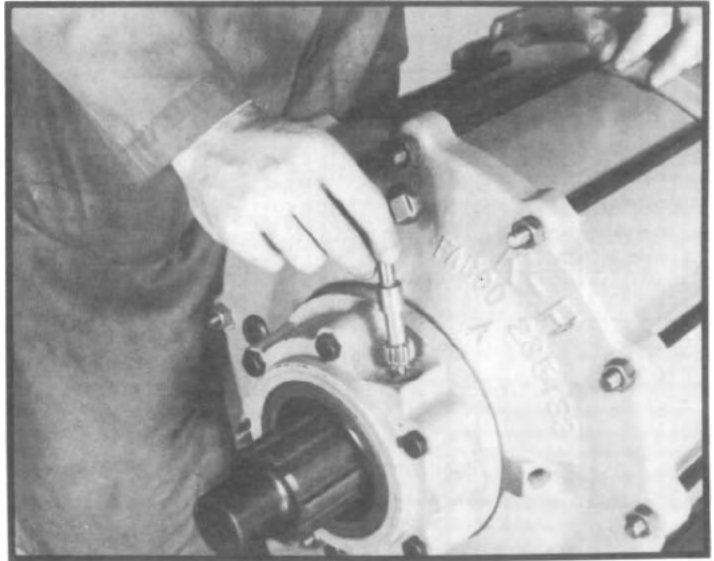

Fig. 110

2.0 Lower Shaft Assembly With 50/50 Differential

- 2.1 Install clutch collar on shaft.
- 2.2 Place the two identical thrust washers over the shaft and against the outside faces of the clutch gear splines. Oil groove side of washer to face outwards and toward the drive gear. (See fig. 111.)

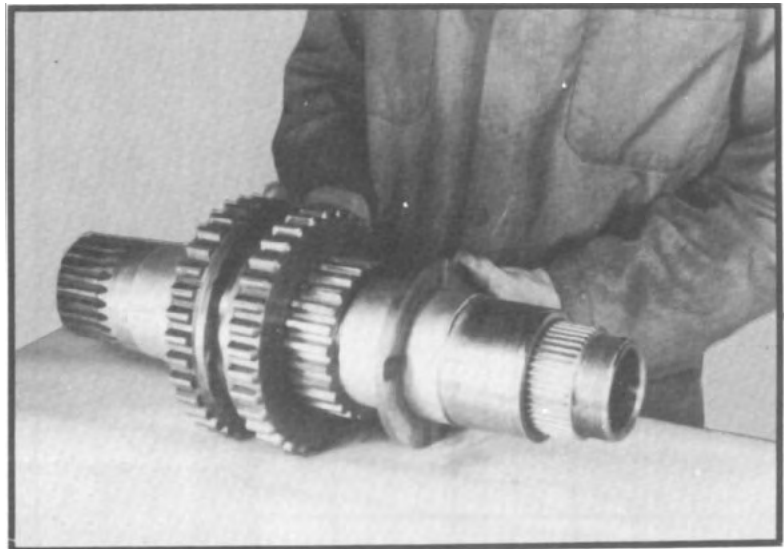

Fig. 111

- 2.3 Tap the needle bearing inner races over each end of shaft with a suitable driver. The wider inner race is located on the front side of the shaft and the shorter' race is located on the rear side. (The needle bearing inner race must be snug against the thrust washer.) (See fig. 112.)

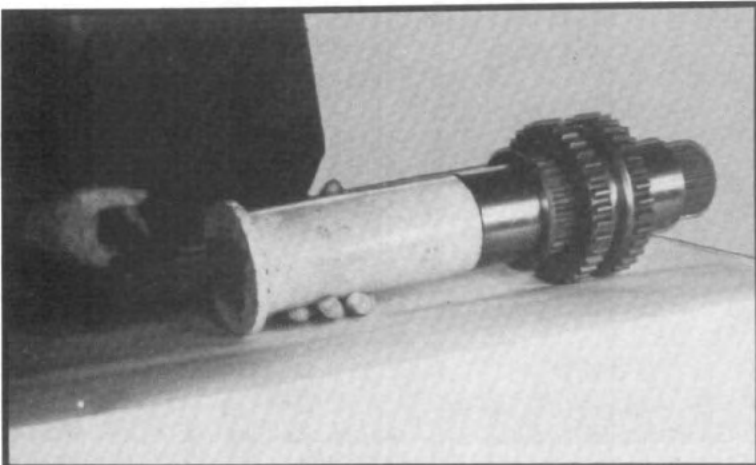

Fig. 112

VII. TRANSFER CASE ASSEMBLY

- 2.4 Slide the two needle bearing assemblies and spacer ring over the front of the shaft. The wider needle bearing, first; spacer ring, second and narrower needle bearing, last. (See fig. 1.13.)

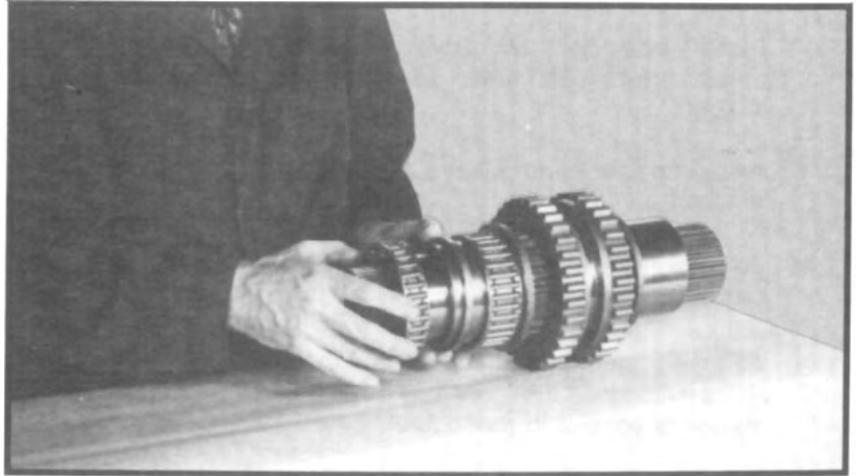
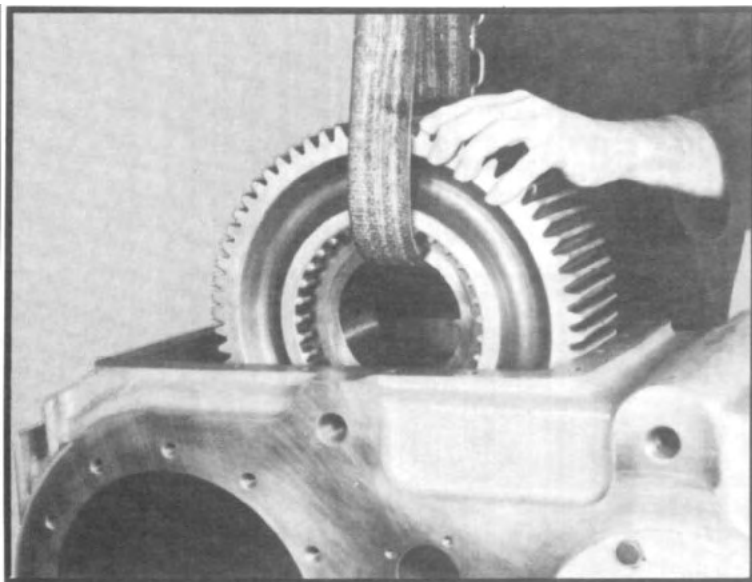

Fig. 113



- 2.5 Place underdrive gear in housing with clutch face inward. (See fig. 114.)

Fig. 114

- 2.6 Install lower shaft assembly into housing through rear bore. (See fig. 115.) Insert shaft assembly into underdrive gear. As shaft assembly enters the front bore, place the thrust washer over front of shaft and against underdrive gear. Place flat side of washer against underdrive gear.

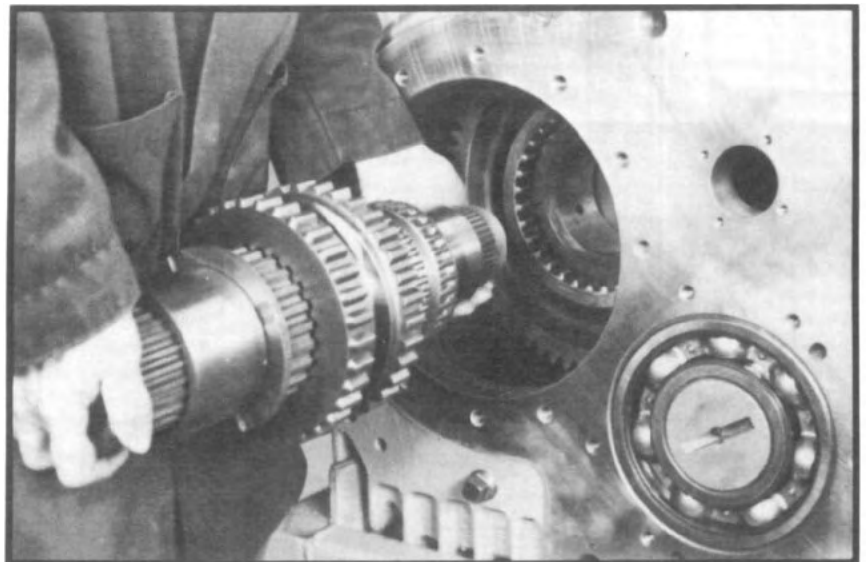

Fig. 115

VII. TRANSFER CASE ASSEMBLY

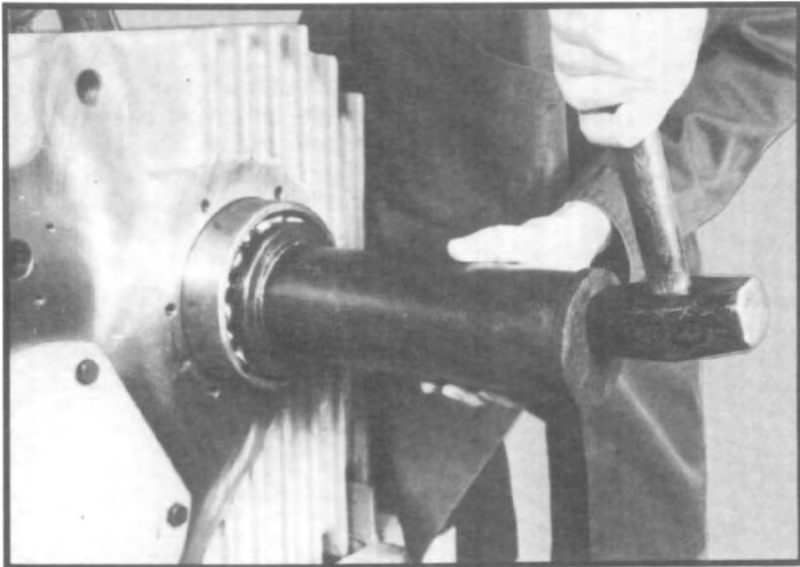

Fig. 116

2.8 Slide clutch gear onto front of shaft and secure to shaft with special nut. (Install nut finger tight.) (See fig. 117.)

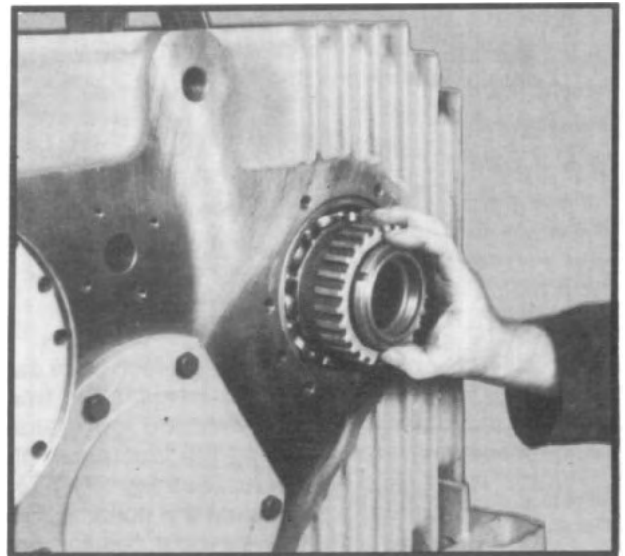

Fig. 117

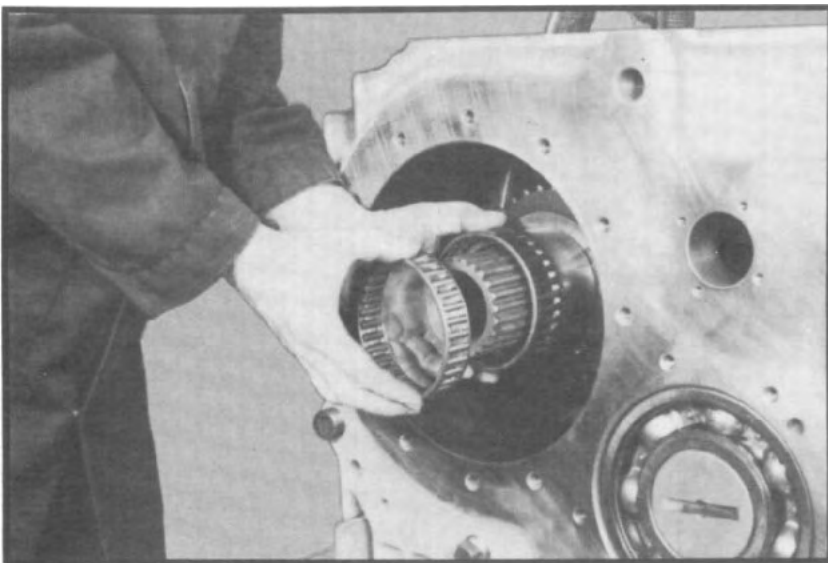

Fig. 118

2.9 Slide the two needle bearing assemblies over the rear of the shaft. The wider needle bearing, first and the narrower needle bearing, last. (See fig. 118.)

VII. TRANSFER CASE ASSEMBLY

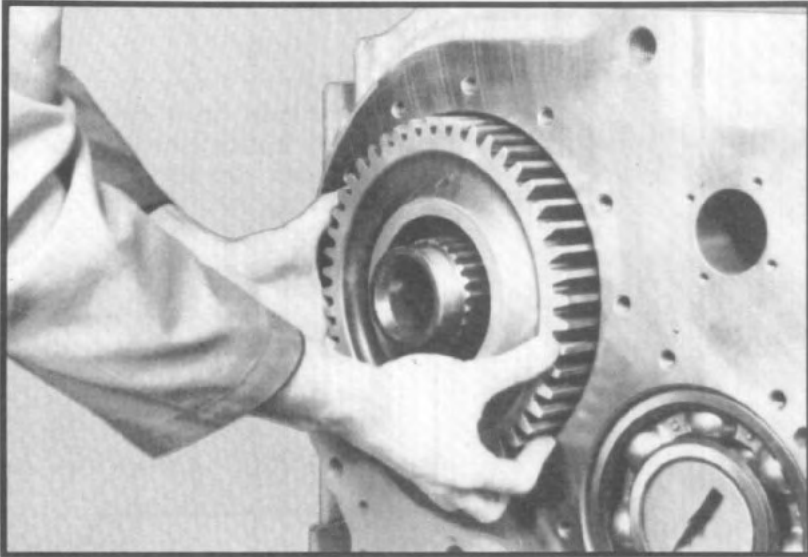

Fig. 119

2.10 Install direct drive gear through the rear case bore and onto rear of shaft with clutch face inwards. (See fig. 119.) Remove chain hoist support from shaft assembly.

2.11 Press lower shaft rear bearing into rear face plate. Tap front of differential case into bearing. Install large diameter o-ring into face plate, if being replaced.

2.12 Place thrust washer onto rear of shaft and against gear. Place flat side of washer against the gear. (See fig. 120.)

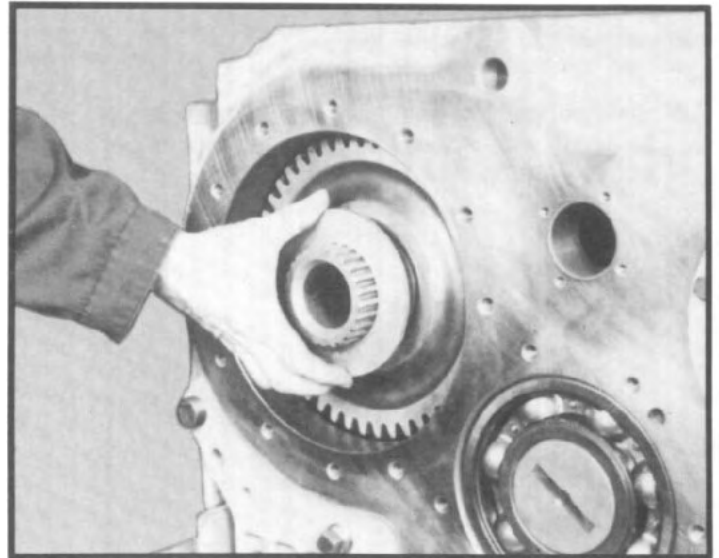

Fig. 120

2.13 Using a chain hoist, install rear face plate and gasket to housing by first inserting the front of the differential case onto the lower shaft spline and then installing the face plate into the lower shaft rear bore. (See fig. 121.) Tap the face plate flush against the housing. Rotate the face plate to the proper position and bolt face plate to housing with 15 capscrews. (See fig. 122.)

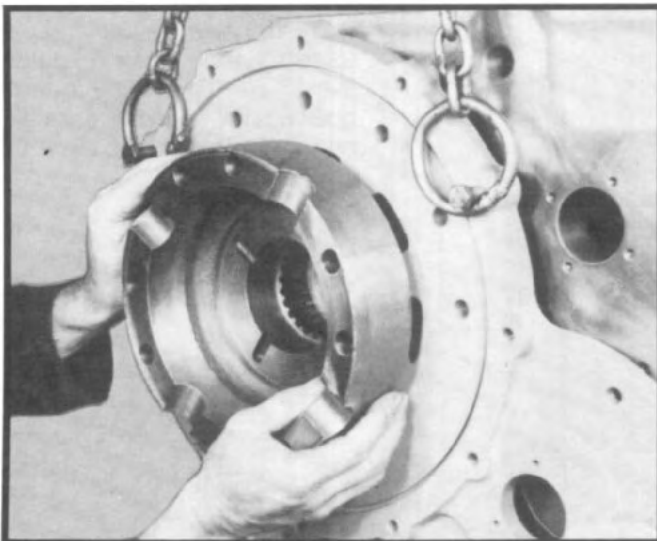

Fig. 121

Pro Gear and Transmission • 906 W. Gore St. Orlando, FL 32805 • 1 (877) 776-4600 / (407) 872-1901

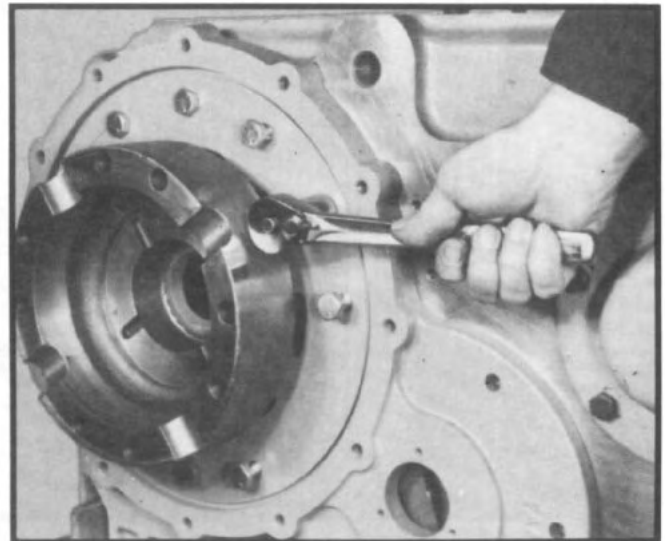

Fig. 122

VII. TRANSFER CASE ASSEMBLY

- 2.14 Install oil pump (with ports facing towards top of case) and gasket to rear face plate using three capscrews. (See fig. 123.) Tighten capscrews to correct torque. If oil pump has been disassembled. Consult Section VII-I.

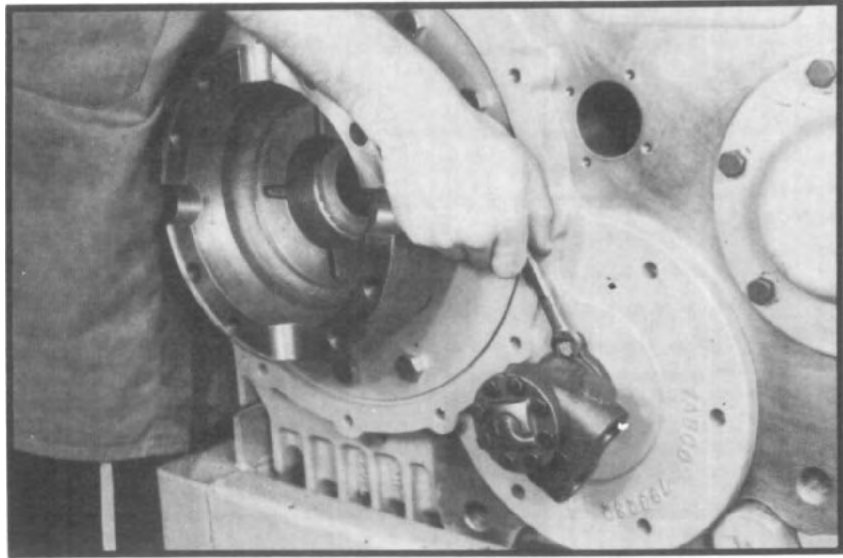

Fig. 123

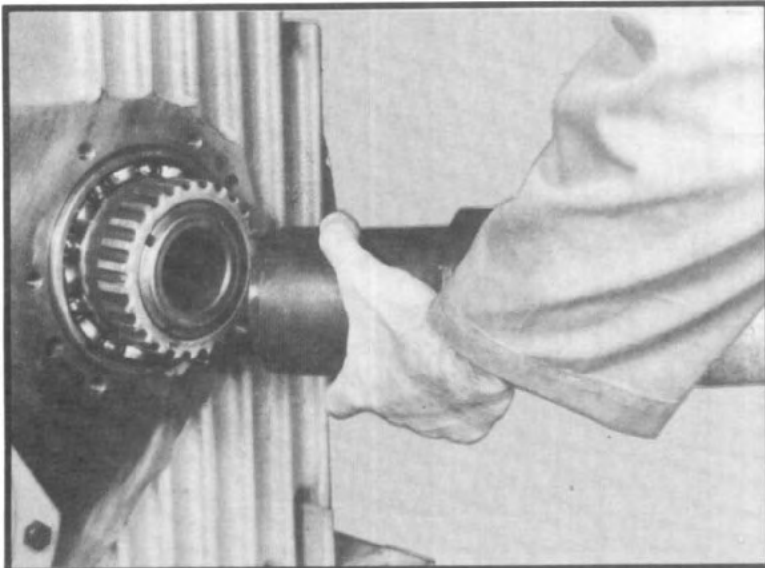

Fig. 124

- 2.15 Tighten special nut on front of lower shaft to correct torque, using a special wrench. (See tool reference, Section X and fig. 124.) With a feeler gauge, measure the end play between the gears and thrust-washers. There should be .015-.020 end play on both gears.

- 2.16 Insert inner shaft through rear of lower shaft assembly and press retaining ring over the groove located on front of inner shaft. (See fig. 125.)

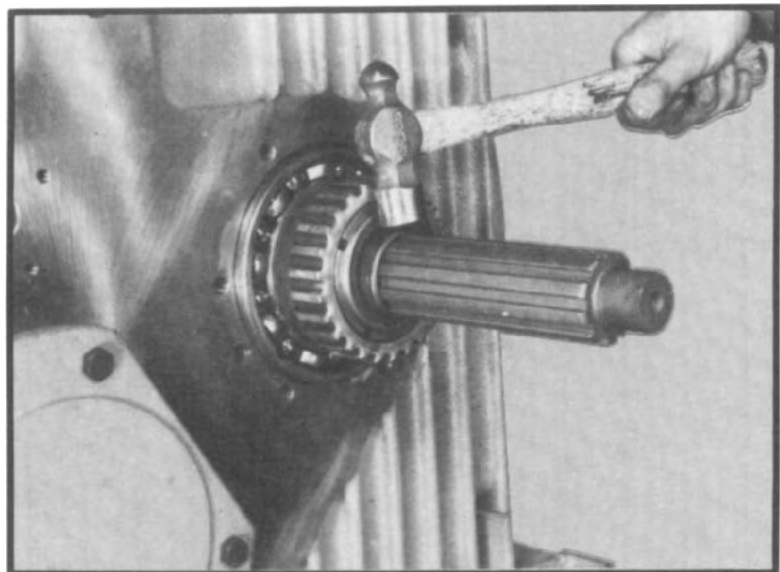

Fig. 125

VII. TRANSFER CASE ASSEMBLY

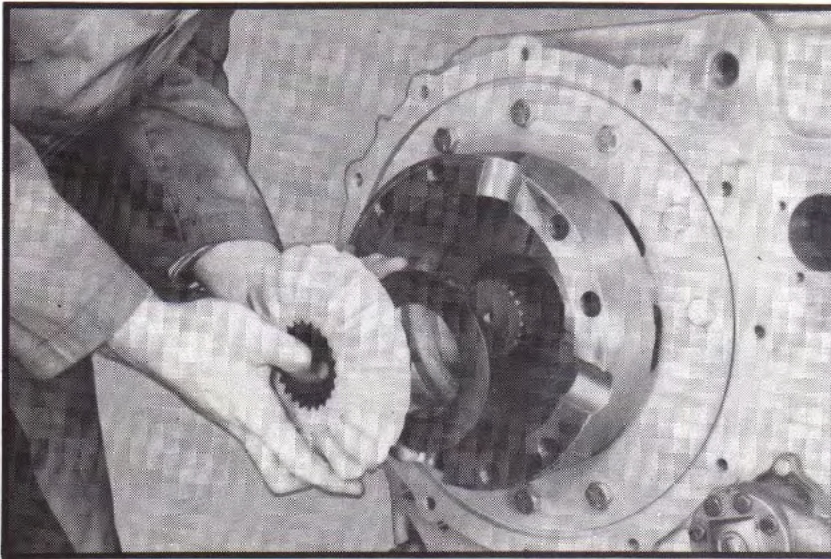

Fig. 126

- 2.17 Slide thrust washer and differential side gear onto spline of inner shaft and into front half of differential case. (See fig. 126.)

- 2.18 Assemble differential side gear and thrust washer to rear half of differential case. (See fig. 127.) Assemble differential spider and pinion gear assembly to rear of differential case (spider and pinion gear, assembly consists of spider, four thrust washers and four pinion gears, See fig. 128.)

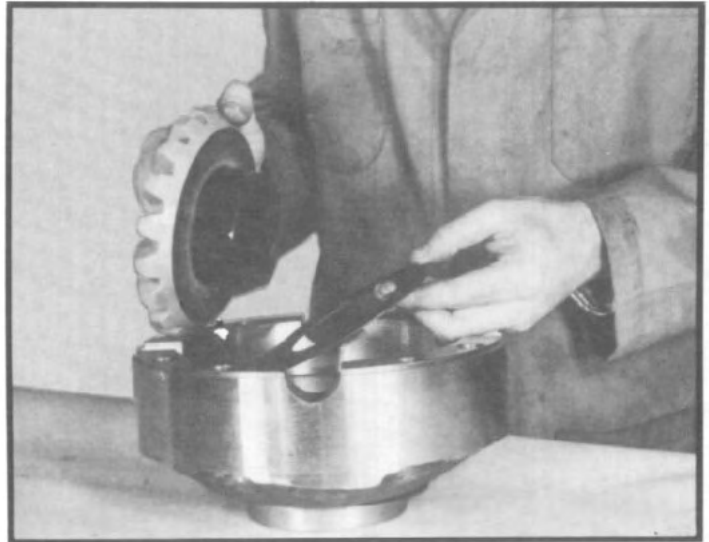

Fig. 127



Fig. 128

VII. TRANSFER CASE ASSEMBLY

2.19 Assemble rear half of differential case with the spider and pinion gear assembly to the front half of the differential case. (See fig. 129.) Make sure to align the alignment marks (denoted by an X on the assembled case halves) when assembling the rear half of the differential case. (See fig. 130.) Bolt halves together using the eight bolts and nuts. Check the differential assembly to see that it rotates freely.

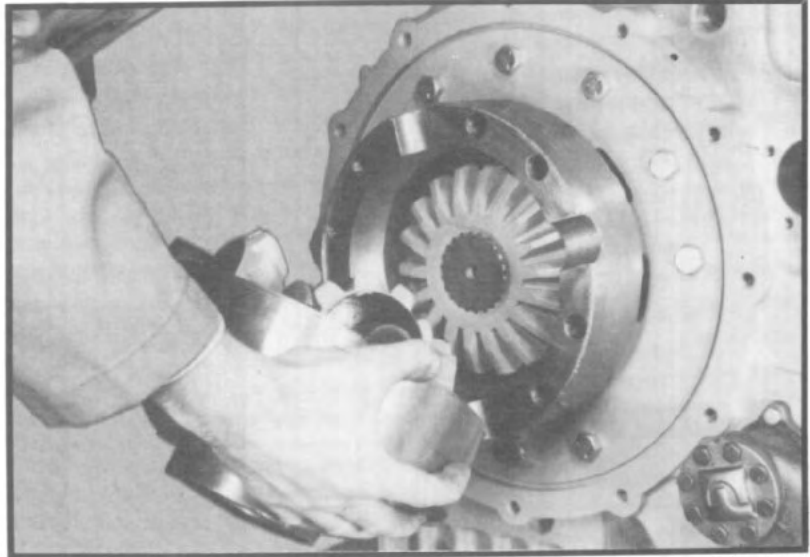

Fig. 129

2.20 Tap bearing onto the rear of the differential case with a suitable driver. Tap evenly on the inner race. Position bearing with shield toward rear.

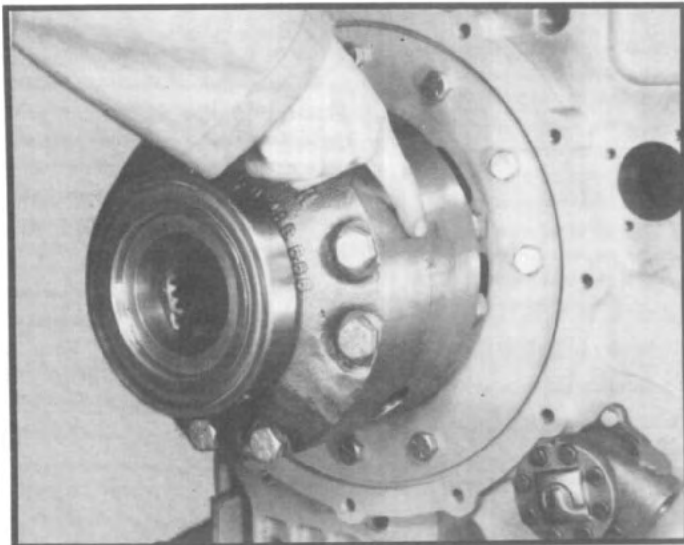

Fig. 130



Fig. 131

2.21 Press double row ball bearing onto rear output shaft with snap ring towards threaded end. Install rear output shaft with bearing into differential carrier cap by tapping on outside race of ball bearing, until retaining ring is flush with cap. install large diameter o-ring into differential cap, if being replaced. (See fig. 131.)

2.22 If seal is being replaced: Tap seal into rear seal carrier with an appropriate driver.

2.23 Install spacer ring and speedometer drive gear on rear output shaft.

2.24 Assemble seal carrier and gasket to differential carrier cap using the six capscrews. Be sure to align oil passages. Tighten capscrews to correct torque. (See fig. 132.)

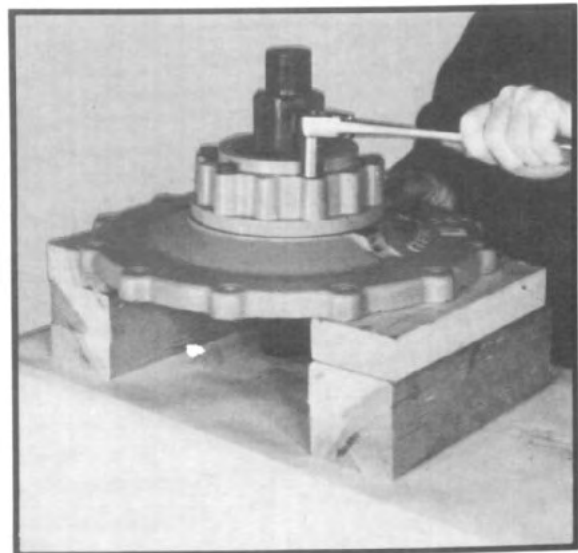

Fig. 132

2.25 Screw twelve studs into rear face plate.

VII. TRANSFER CASE ASSEMBLY

2.26 Tap differential housing into rear face plate and against o-ring. (See fig. 133.)

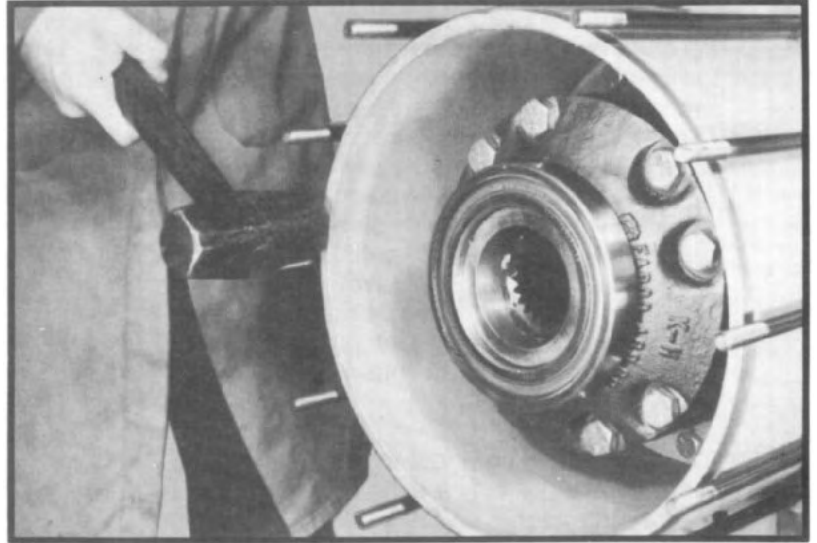

Fig. 133

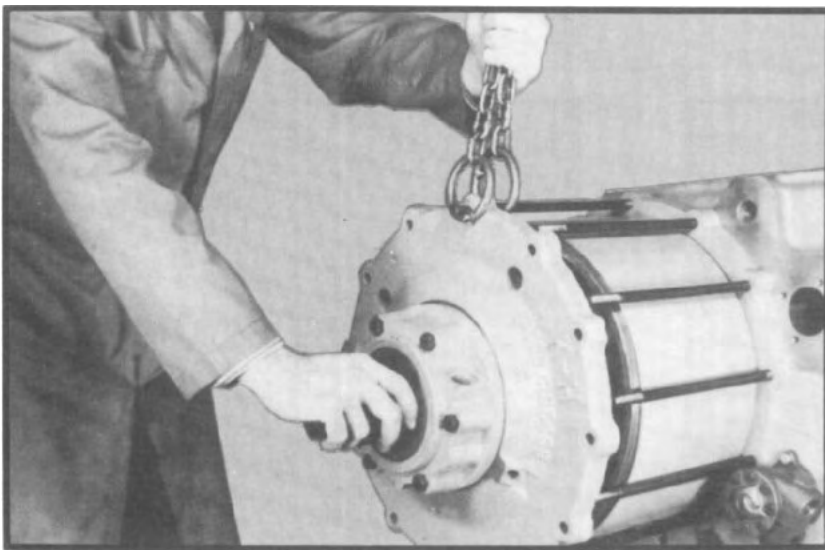

Fig. 134

2.27 Using a chain hoist, lift the differential cap assembly into place. Work the rear output shaft into the splines of the differential case. Be sure the oil drain plug is facing toward the bottom of the transfer case. Push the differential carrier cap onto the studs and tap the cap firmly against the differential housing. Housing must be seated evenly inside the differential cap. (See fig. 134.)

2.28 Assemble stud nuts to studs and tighten nuts to correct torque. (See fig. 135 and fig. 136.)

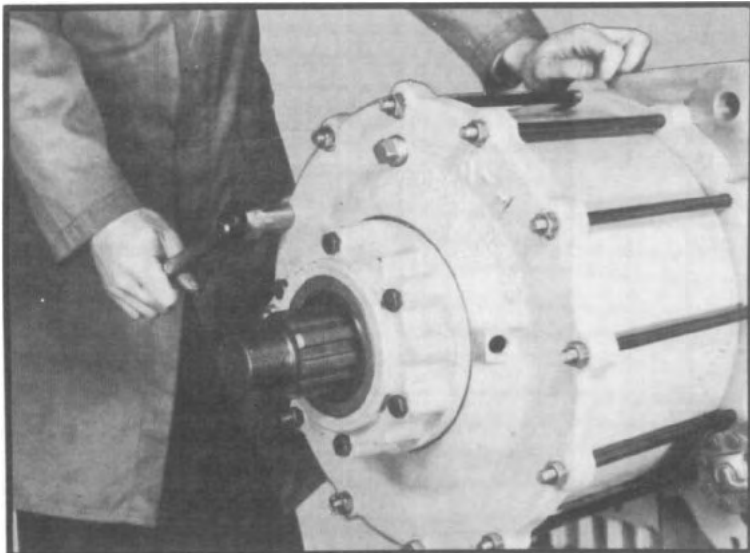

Fig. 135

Pro Gear and Transmission • 906 W. Gore St. Orlando, FL 32805 • 1 (877) 776-4600 / (407) 872-1901

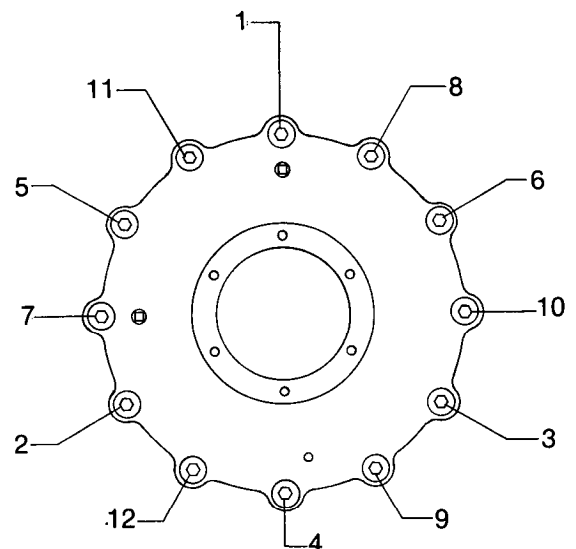

Fig. 136

Bolt or nut tightening sequence for proportional differential carrier caps.

VII. TRANSFER CASE ASSEMBLY

- 2.29 Install speedometer drive gear into seal carrier to mesh correctly with drive gear. (See fig. 137.)
- 2.30 Install speedometer sleeve, tightening securely.
- 2.31 Coat the hub of the output flange or yoke with gear lubricant and slide the flange or yoke onto rear output shaft.
- 2.32 Assemble washer and locknut to rear output shaft. Tighten locknut to correct torque.

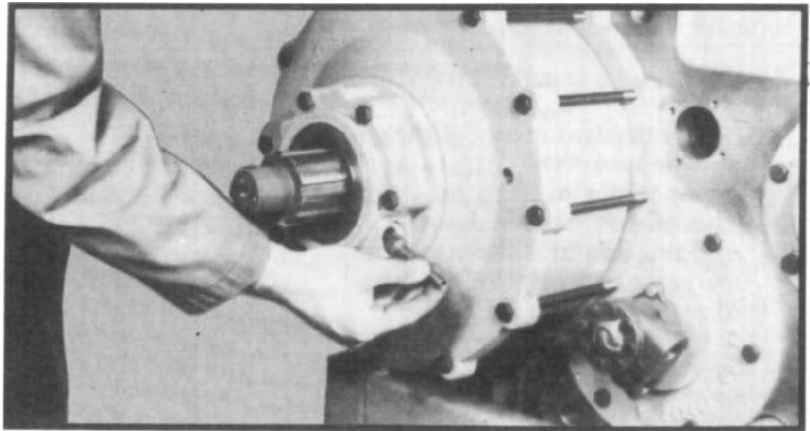

Fig. 137

VII. TRANSFER CASE ASSEMBLY

3.0 Lower Shaft Assembly With 26/74 Differential

- 3.1 Install clutch collar on shaft.
- 3.2 Place the two identical thrust rings over the shaft and against the outside faces of the clutch gear splines. Oil groove side of washer to face outwards and toward the drive gear. (See fig. 55)

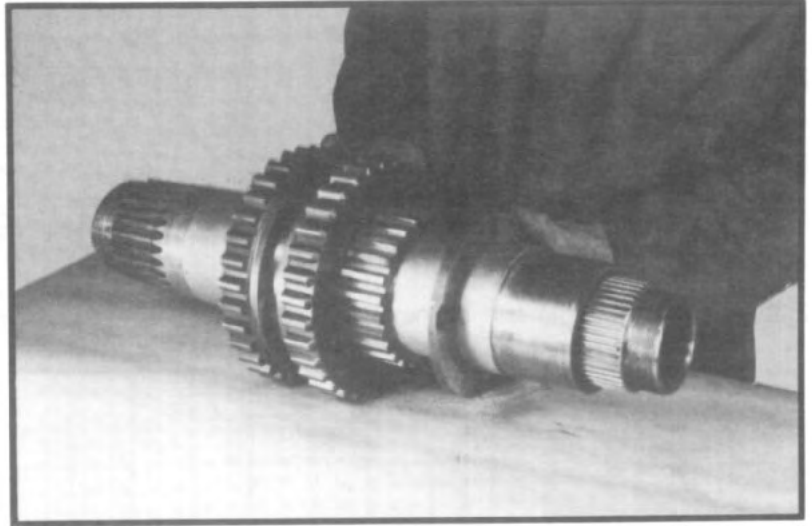

Fig. 138

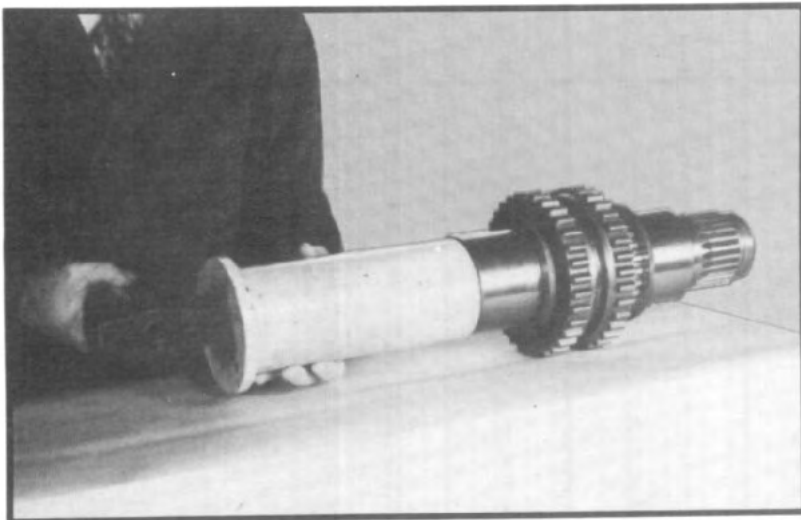

Fig. 139

- 3.3 Tap the needle bearing inner races over each end of shaft. (The needle bearing inner race must be snug against the thrust washer, See fig. 139.)

- 3.4 Slide the two needle bearing assemblies and spacer ring over the front of the shaft. The wider needle bearing, first; spacer ring, second and narrower needle bearing, last. (See fig. 140.)

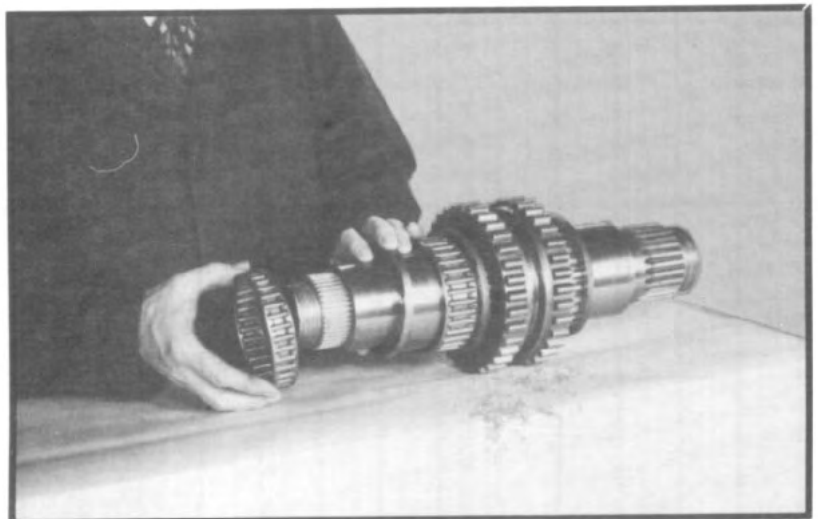

Fig. 140

VII. TRANSFER CASE ASSEMBLY

- 3.5 Place underdrive gear in housing with clutch face inward. (See fig. 141.)

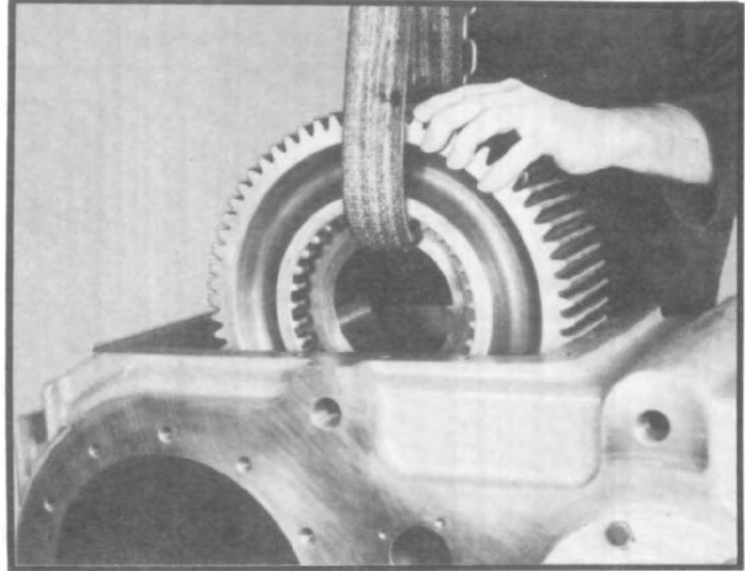

Fig. 141

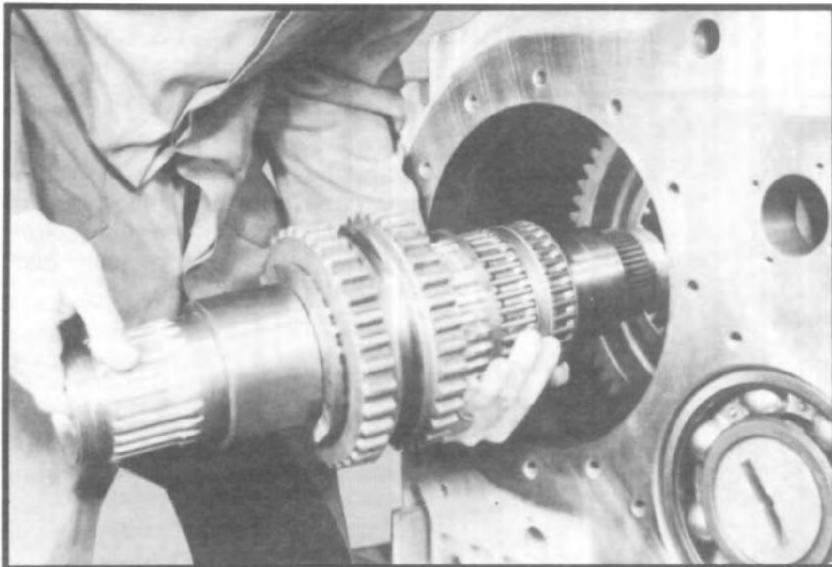

Fig. 142

- 3.6 Install lower shaft assembly into housing through rear bore. (See fig. 142.) Insert shaft assembly into underdrive gear. As shaft assembly enters the front bore, place the thrust washer over front of shaft and against underdrive gear. Place flat side of washer against the gear.

- 3.7 Install lower shaft front ball bearing on front of shaft. Supporting the shaft assembly with a chain hoist, tap the ball bearing with a suitable driver to push the bearing into the housing. (Tap evenly on inner race.) Do not remove the chain hoist support until after Step 10. (See fig. 143.)

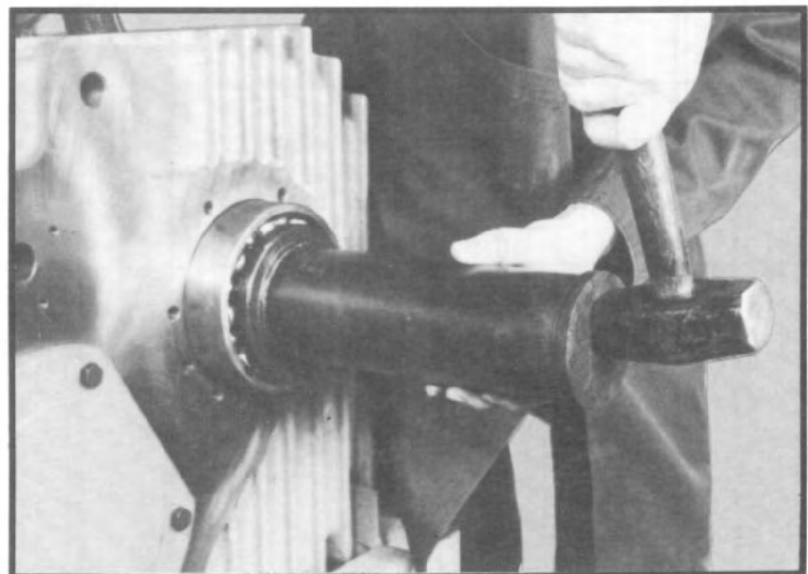

Fig. 143

VII. TRANSFER CASE ASSEMBLY

3.8 Slide clutch gear onto front of shaft and secure to shaft with special nut. (See fig. 117.)

3.9 Slide the two needle bearing assemblies over the rear of the shaft. The wider needle bearing, first and the narrower needle bearing, last. (See fig. 144.)

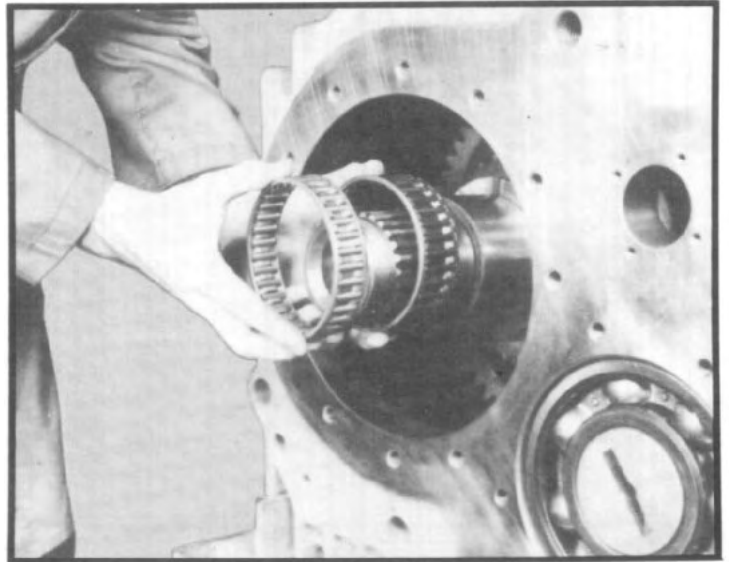

Fig. 144

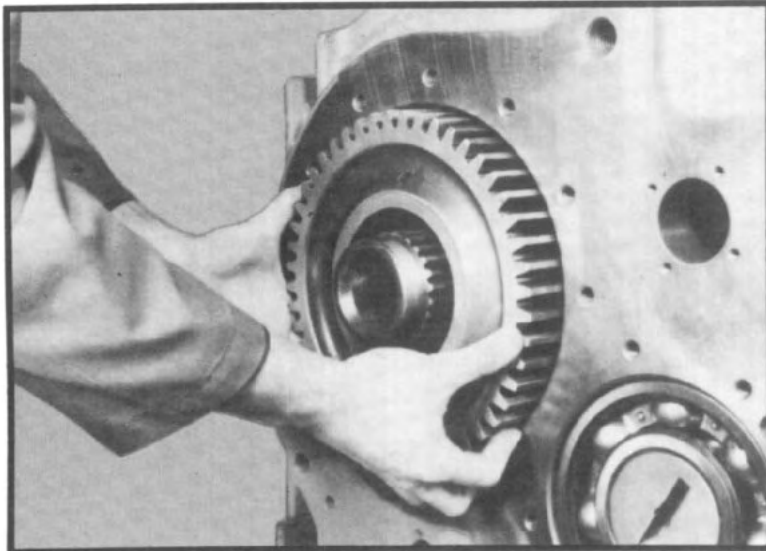

Fig. 145

3.10 Install direct drive gear through rear case bore and onto rear of shaft with clutch face inwards. (See fig. 145.) Remove chain hoist support from shaft assembly.

3.11 Place thrust washer onto rear of shaft and against gear. Place flat side of washer against the gear. (See fig. 146.)

3.12 Tap lower shaft rear roller bearing onto the rear of the lower shaft with a suitable driver.

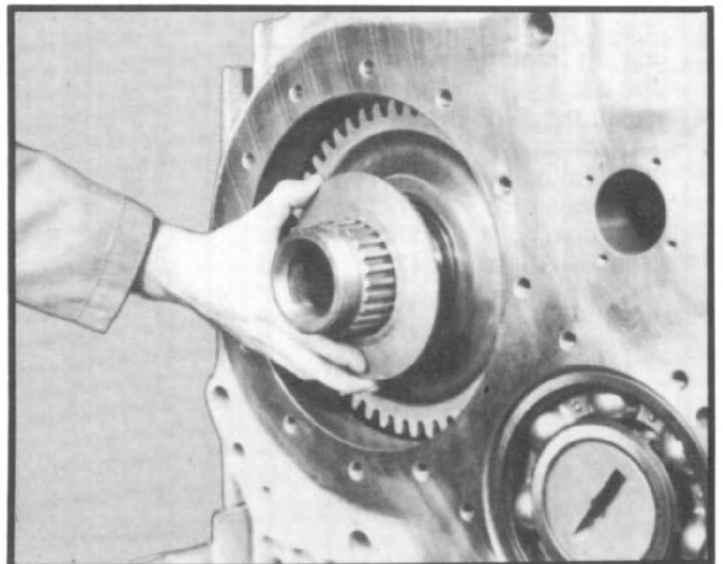

Fig. 146

VII. TRANSFER CASE ASSEMBLY

- 3.13 Install large diameter o-ring into face plate, if o-ring is being replaced. Using a chain hoist, install rear face plate and gasket to housing by first inserting the face plate into the lower shaft rear bore and tapping the face plate flush against the housing. (See fig. 147.) Rotate the face plate to the proper position and bolt face plate to housing with 15 capscrews. (See fig. 148.)

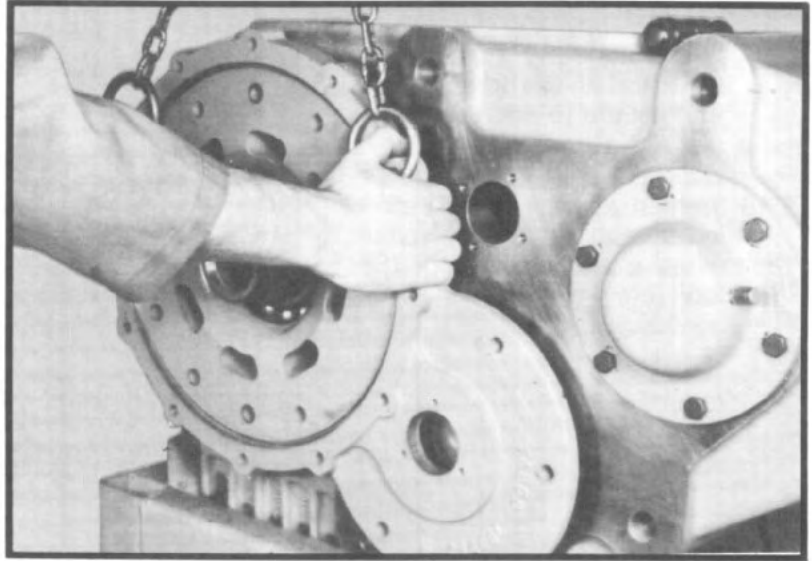

Fig. 147

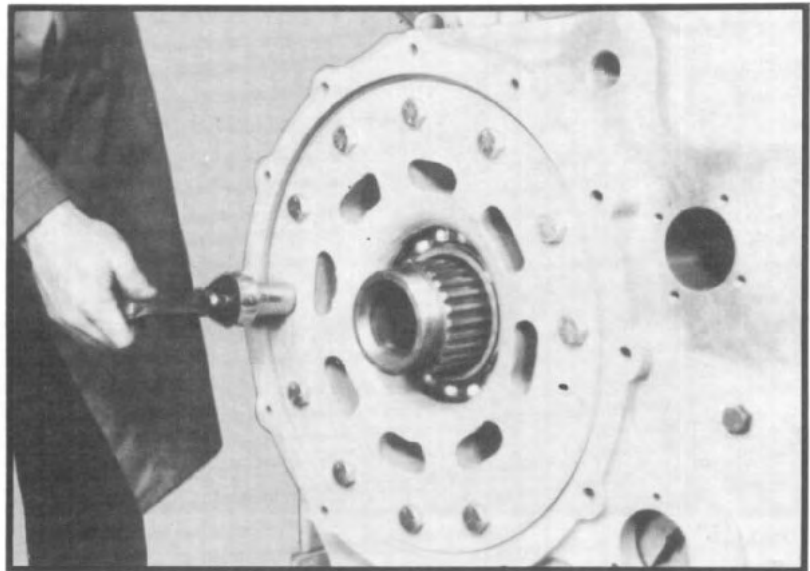

Fig. 148

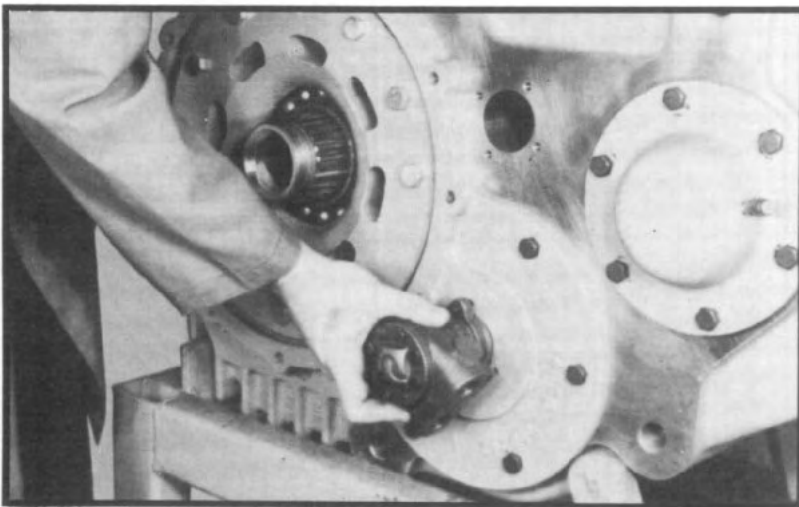

Fig. 149

- 3.14 Install oil pump, with ports facing towards top of case, (See fig. 149.) and gasket to rear face plate using three capscrews. Tighten capscrews to correct torque. If oil pump has been disassembled, consult Section VII-I.

VII. TRANSFER CASE ASSEMBLY

3.15 Slide planetary carrier onto the, rear of the lower shaft, and secure to shaft with special nut.

3.16 Tighten special nut on rear of lower shaft to correct torque, using a special wrench. (See tool reference, Section X and fig. 150.)

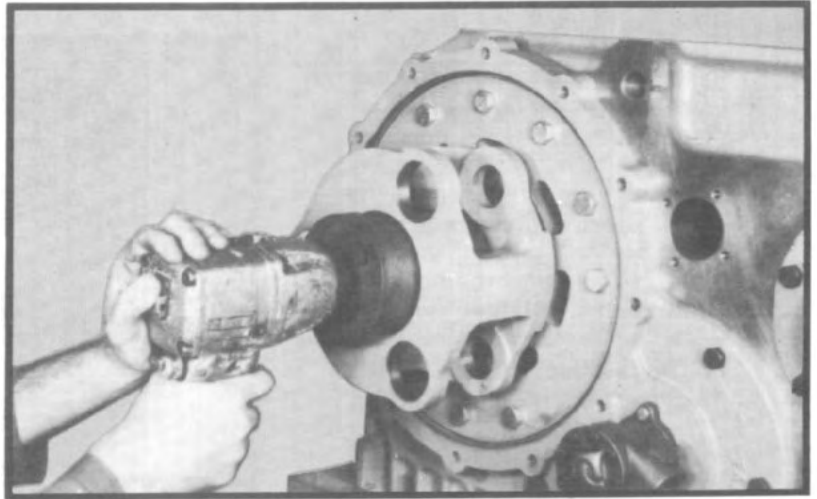

Fig. 150

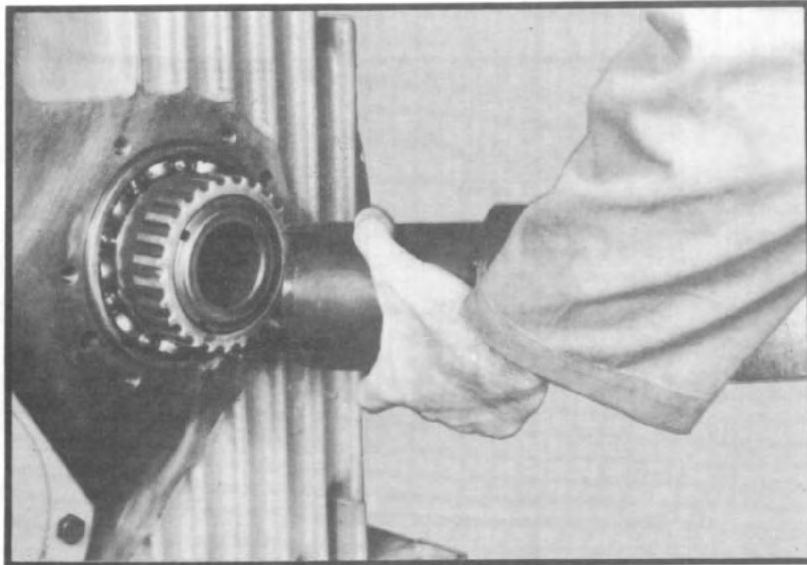

Fig. 151

3.17 Tighten special nut on front of lower shaft to correct torque, using a special wrench. (See tool reference, Section X and fig. 151.) With a feeler gauge, measure the end play between the gears and the thrust washers. There should be .015-.020 end play on both gears.

3.18 Assemble sun gear to shaft by installing inner (round) retaining ring (if removed), installing sun gear, smaller counterbore over retaining ring, and installing outer snap ring. Insert sun gear shaft through rear of lower shaft assembly and press retaining ring over the groove located on front of shaft. (See fig. 152.)

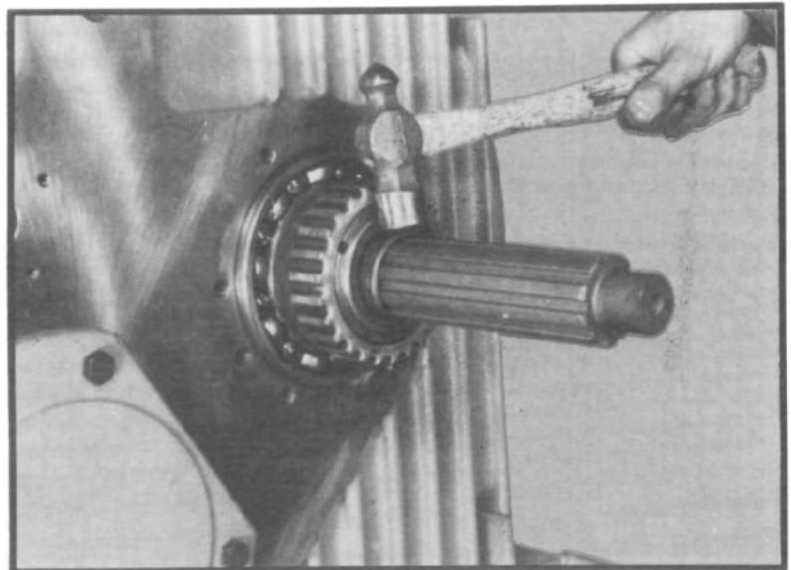
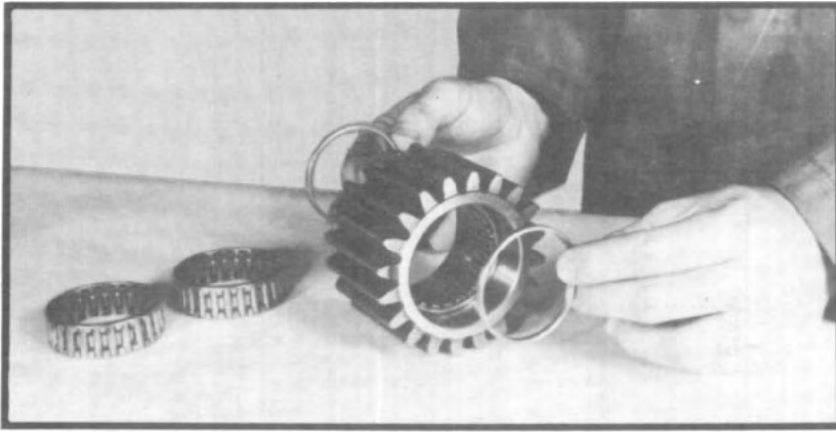

Fig. 152

VII. TRANSFER CASE ASSEMBLY



3.19 Install three needle bearings and two spacers into each planet gear. (See fig. 153.)

Fig. 153

3.20 Slide planet gear with needle bearings into planetary carrier, add planet pin spacers on each side of planet gear and slide planet pin through spacers and gear. Repeat procedure for remaining two planet gears. (See fig. 154.)

3.21 Install snap ring on the end of each planet pin.

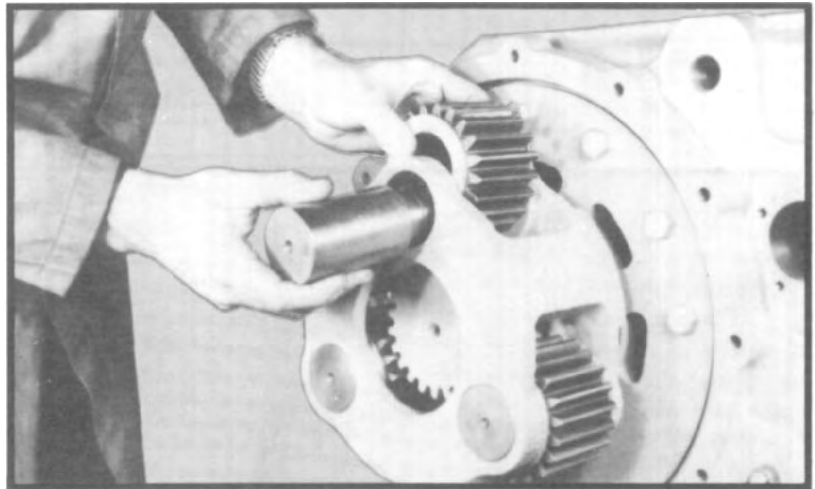

Fig. 154

3.22 Tap planetary housing into rear face plate and against o-ring. (See fig. 155.)

3.23 Tap ball bearing into planetary carrier cap. Install large diameter o-ring into planetary cap, if being replaced.

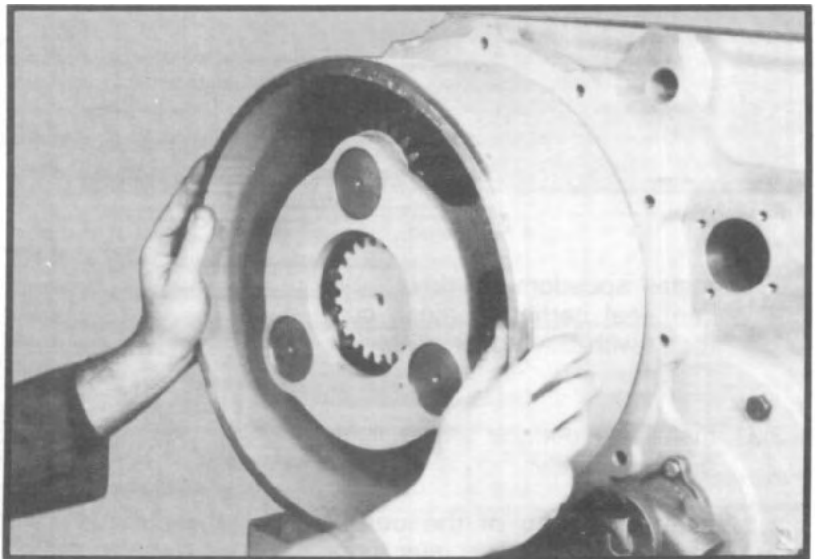

Fig. 155

3.24 Tap planetary carrier cap onto rear output shaft-internal gear assembly. Tap inside race of double row ball bearing. (See fig. 156.)

3.25. If seal is being replaced: Tap seal into rear seal carrier with an appropriate driver.

3.26. Install spacer ring and speedometer drive gear on front of output shaft.



Fig. 156

- 3.27 Assemble seal carrier and gasket to planetary carrier cap using the six capscrews. Be sure to align oil passages. Tighten capscrews to correct torque. (See fig. 157.)

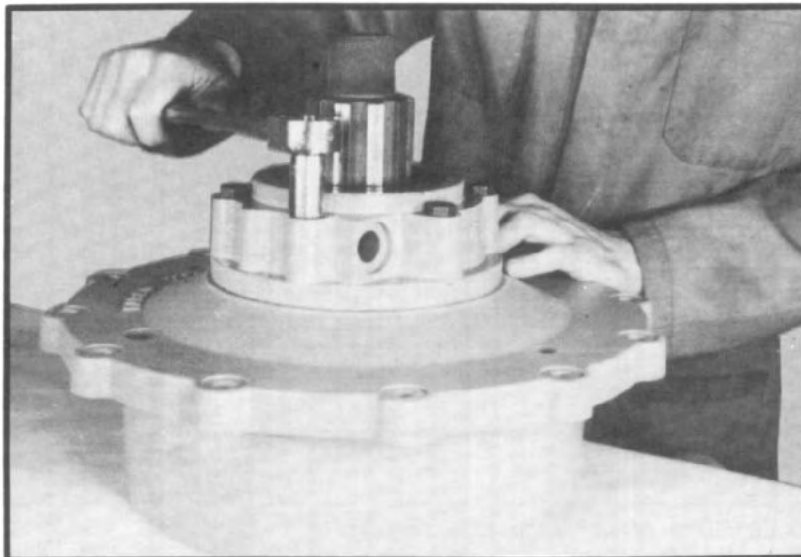
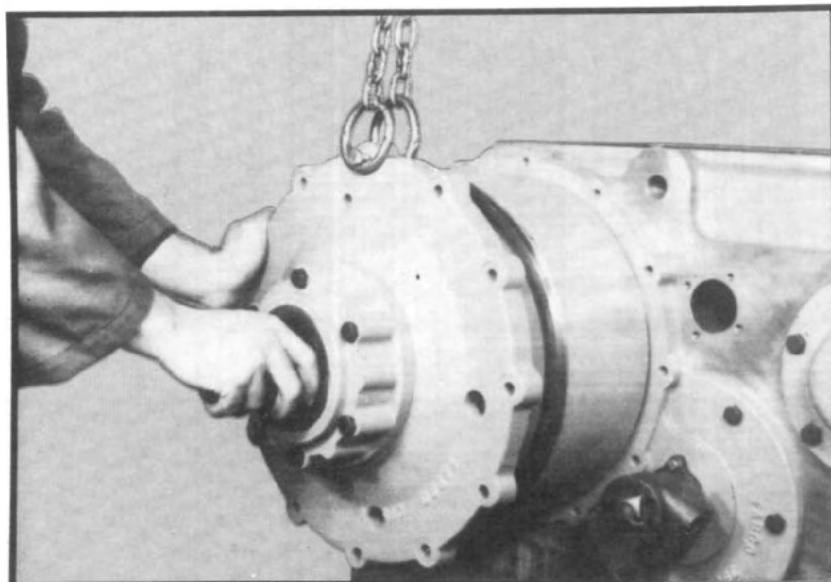

Fig. 157



- 3.28 Using a chain hoist, lift the planetary cap assembly into place. Slide planetary internal gear onto the planetary gears (See fig. 158.) Be sure the oil drain plug is facing toward the bottom of the transfer case. Tap planetary cap firmly onto planetary housing.

- 3.29 Assemble capscrews to planetary cap and tighten to correct torque. (See fig. 136.)

Fig. 158

- 3.30 Install speedometer drive gear into seal carrier to mesh correctly with drive gear. (See fig. 159.)
- 3.31 Install speedometer sleeve, tightening securely.
- 3.32 Coat the hub of the output flange or yoke with gear lubricant and slide the flange or yoke onto rear output shaft.
- 3.33 Assemble washer- and locknut to rear output shaft. Tighten locknut to correct torque.

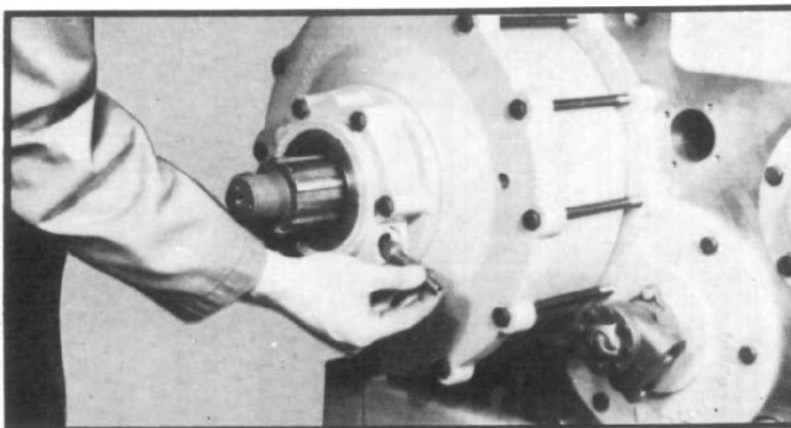

Fig. 159

VII. TRANSFER CASE ASSEMBLY

E. Lockout Assembly

1. Assemble the lockout housing and gasket to the front of the transfer case with the six cap-screws. Be sure to align oil passages. (See fig. 160.)

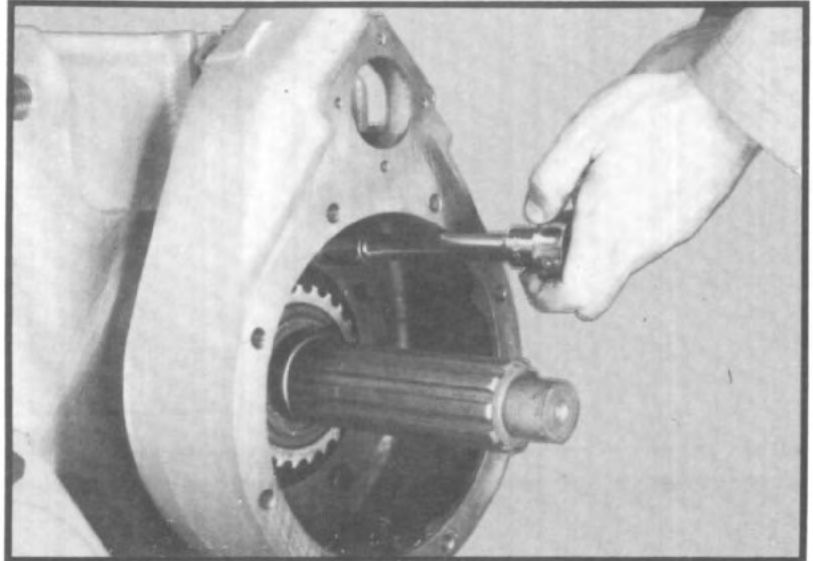
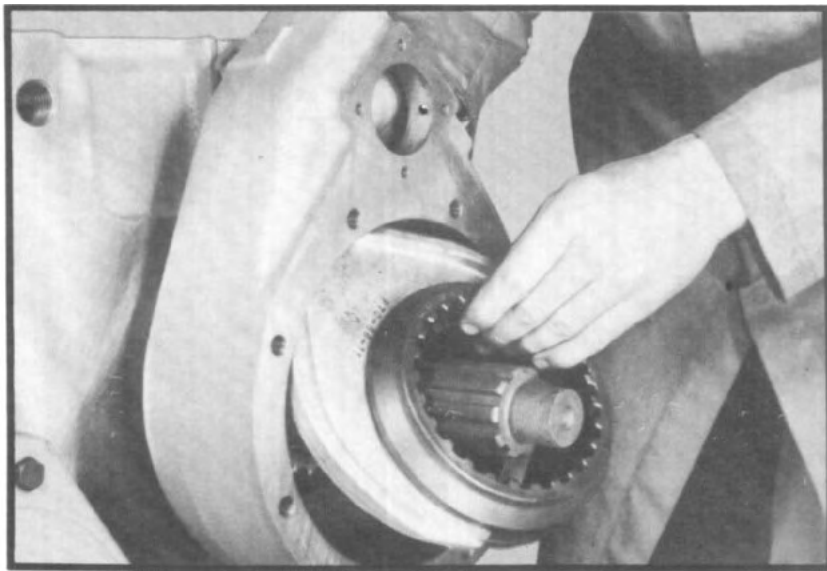

Fig. 160



2. Slide clutch collar onto shift fork and install the two parts together into the lockout housing. The tapped holes in the shift fork must face toward indicator switch position. (See fig. 161.)

Fig. 161

3. Slide the lockout gear onto the spline of inner shaft and into the clutch collar. (See fig. 162.)

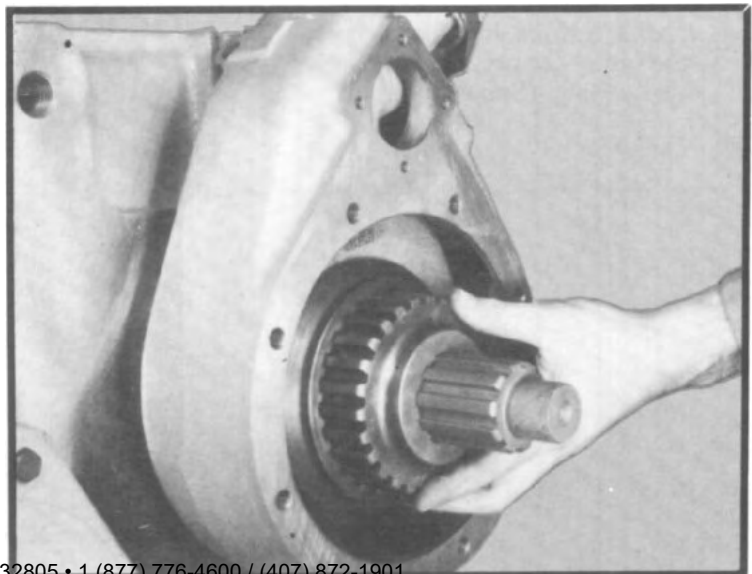

Fig. 162

VII. TRANSFER CASE ASSEMBLY

4. Install shift shaft through shift fork and into lockout housing. Align two grooves in shaft with clamping screw holes. (See fig. 163.)

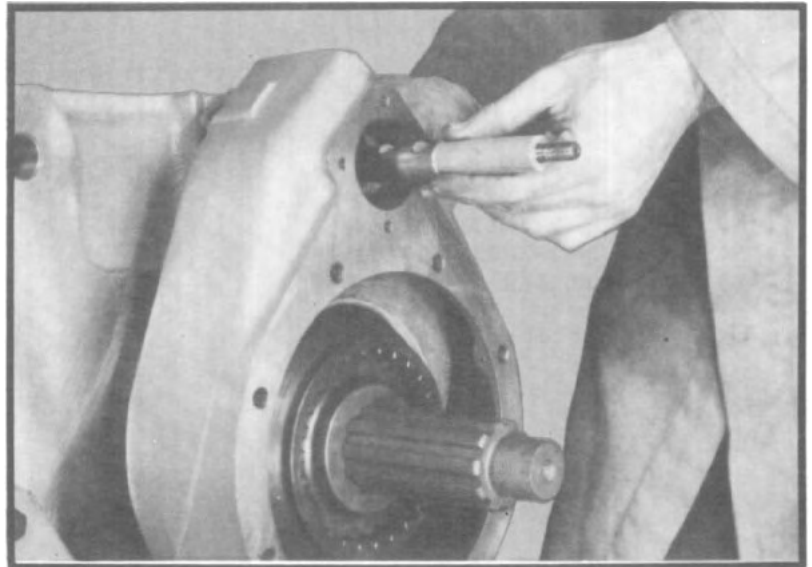

Fig. 163

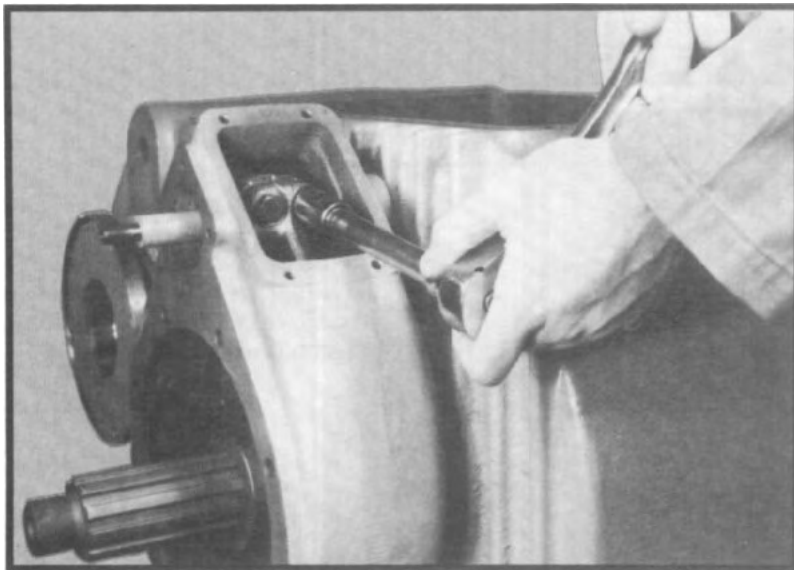

Fig. 164

5. Install two shift fork clamping screws and tighten to correct torque. Secure clamp screws with lockwire. (See fig. 164.) If clamp screw heads are not easily accessible as shown, the shift fork is installed backward.

6. Install o-rings in adapter tube and insert adapter tube into lock-out housing. (See fig. 165.)

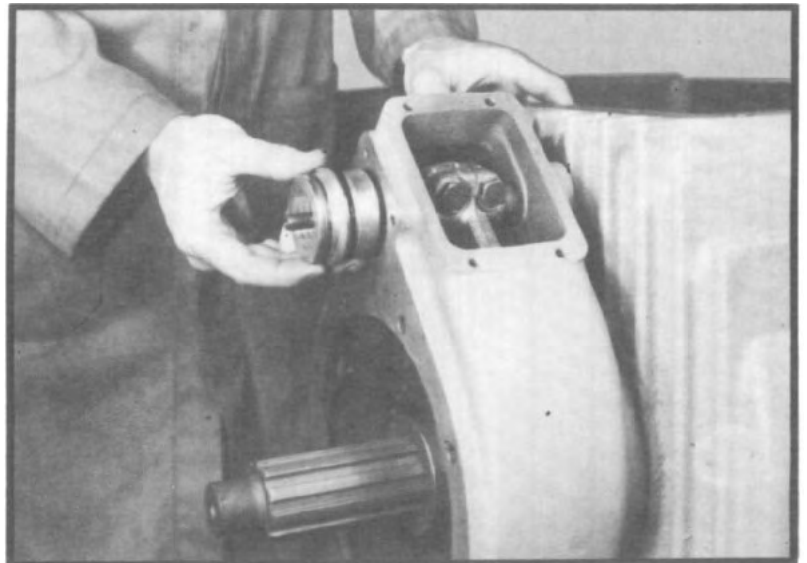

Fig. 165

7. Place stop ring over shift shaft and place spring over end of shift shaft.
8. Place small o-ring over threads of shift shaft.
9. Place piston over threads of shift shaft (depressing spring) with shallower of two grooves facing towards shaft. (See fig. 166 and 167.)
10. Install shift shaft nut and washer. Tighten nut to correct torque.



Fig. 166

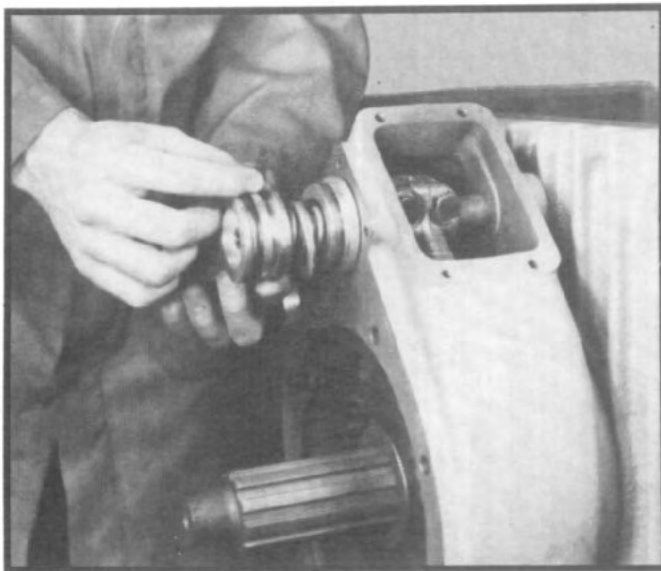

Fig. 168

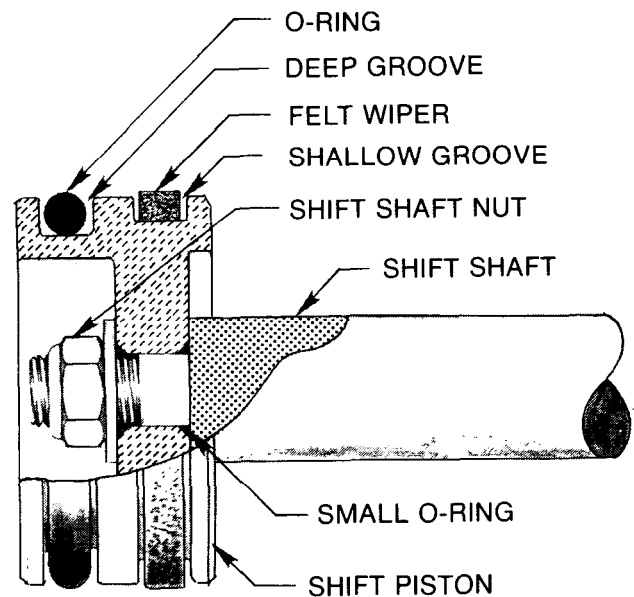

Fig. 167

11. Place an oil soaked felt wiper in shallow groove on piston and an o-ring into deep groove. (See fig. 168 and fig. 167.)
12. Coat the shift cylinder tube lightly with gear lubricant. Place cylinder tube over piston and over adapter tube. (Use care not to cut or displace o-rings.)
13. Install o-ring into shift cylinder cap.
14. Install cylinder cap on cylinder tube with four long capscrews, tightening to correct torque. Tighten capscrews evenly to prevent cocking the cylinder cap. (See fig. 169.)

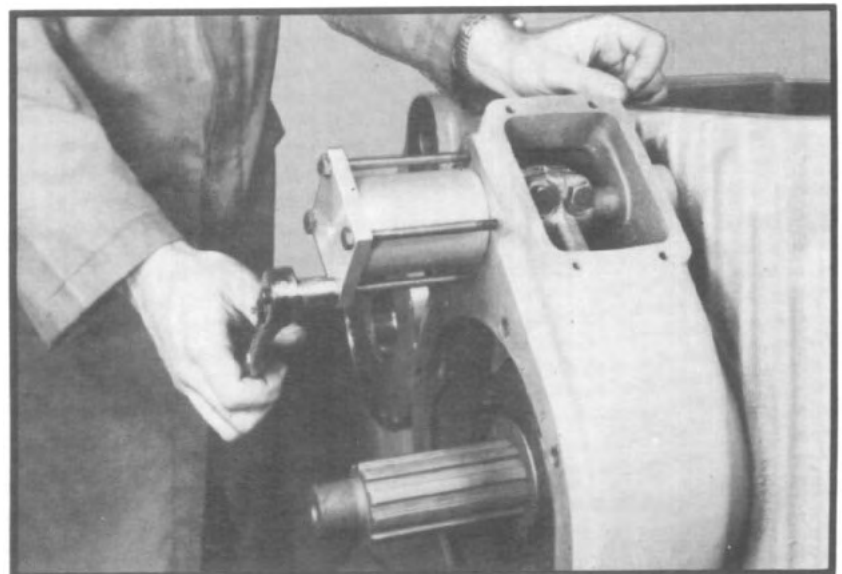

Fig. 169

VII. TRANSFER CASE ASSEMBLY



Fig. 89

15. Apply cover plate gasket to lockout housing.
16. Install cover plate with four capscrews, tightening to correct torque. (See fig. 170.)
17. Insert plunger into indicator switch hole.
18. Install indicator switch, shimming with copper washers as necessary for proper operation; check with continuity checker.

19. Install double row ball bearing into carrier and assemble bearing carrier and gasket to lockout housing with eight capscrews. Tighten capscrews to correct torque. (See fig. 171.)
20. If seal is being replaced: Tap seal into front seal carrier with an appropriate driver.

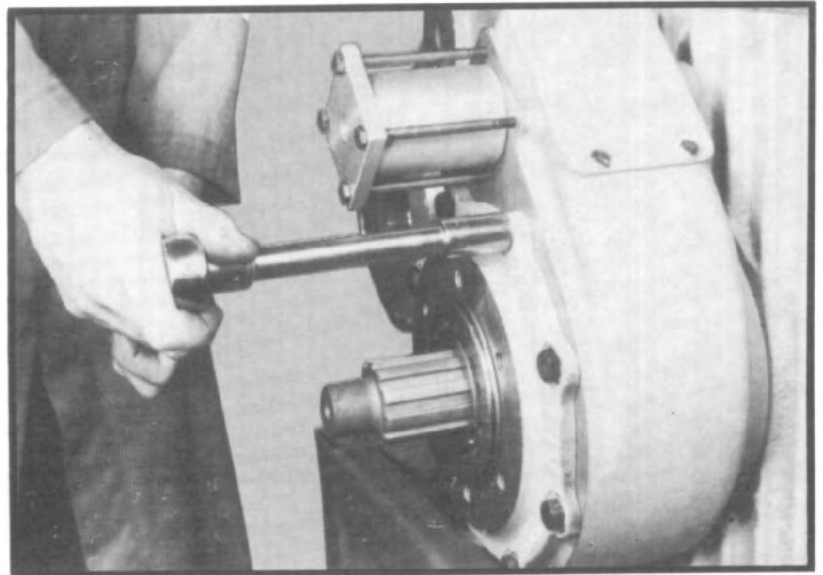
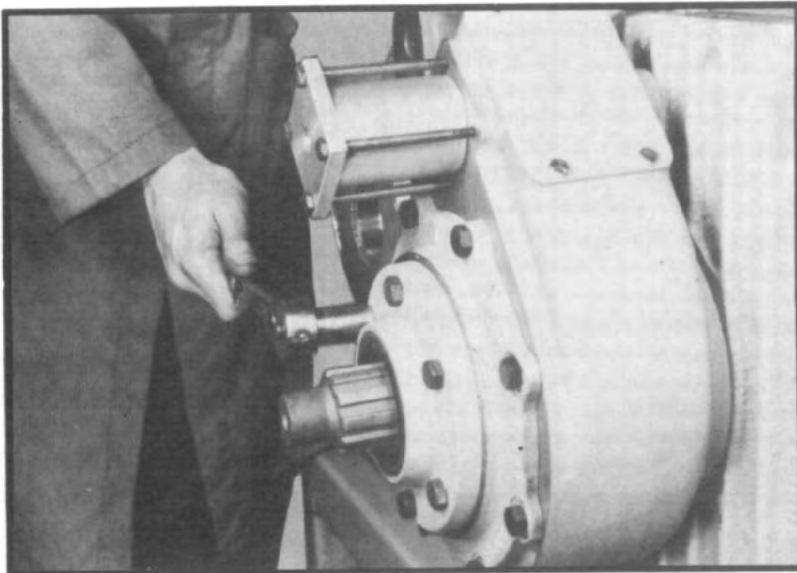

Fig. 90



21. Assemble seal carrier and gasket to bearing carrier with capscrews. Tighten capscrews to correct torque. (See fig. 172.)
22. Coat the hub of the companion flange with gear lubricant and slide companion flange onto output shaft.
23. Assemble washer and nut to front output shaft. Tighten locknut to correct torque.

Fig. 91

VII. TRANSFER CASE ASSEMBLY

F. PTO And Declutch Assembly

Note: The PTO and declutch assemblies are similar except for the manner in which the housings are bolted to the transfer case. See figs. 173 and 174 for mounting of appropriate housing.

1. Bolt PTO/declutch housing and gasket to main case with six capscrews. Be sure to align oil passages. Tighten capscrews to correct torque. (See fig. 173)

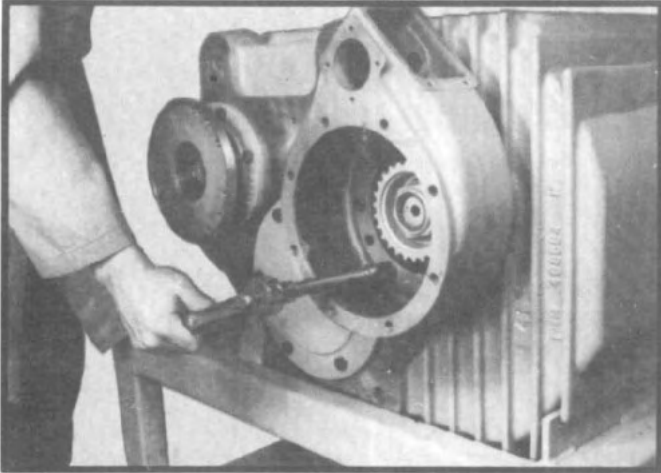

Fig. 173 Location of Declutch Housing

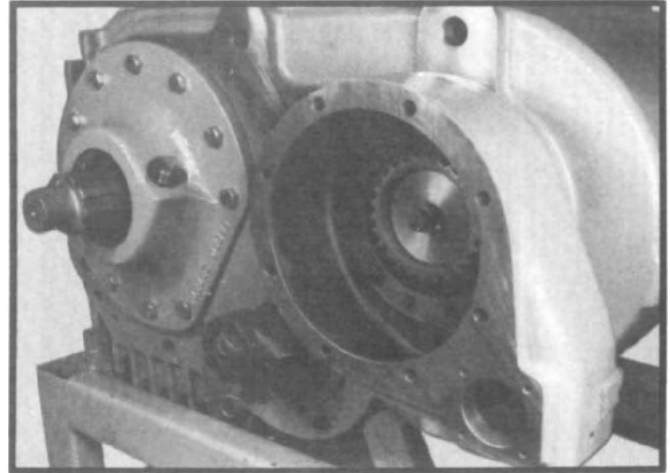

Fig. 174 Location of PTO Housing

2. Slide clutch collar onto shift fork and install the two parts together into the PTO/declutch housing, sliding the clutch collar over the declutch gear. The tapped holes in the shift fork must face toward indicator switch position. (See fig. 175)

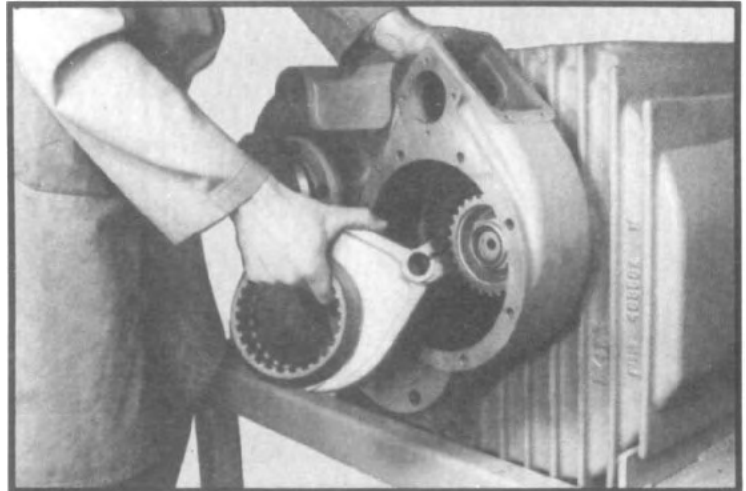

Fig. 175

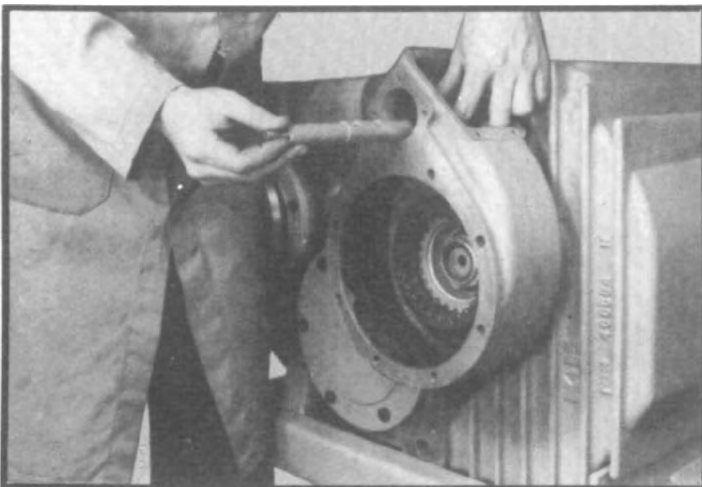

Fig. 176

3. Install shift shaft through shift fork and into PTO/declutch housing. Align two grooves in shaft with clamping screw holes. (See fig. 176)

VII. TRANSFER CASE ASSEMBLY

4. Install two shift fork clamping screws and tighten to correct torque. Secure clamp screws with lockwire. (See fig. 177.) If clamp screw heads are not easily accessible as shown, the shift fork is installed backward.

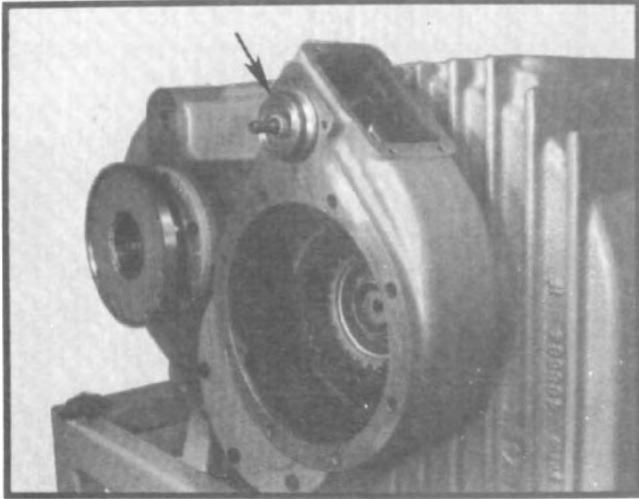

Fig. 178

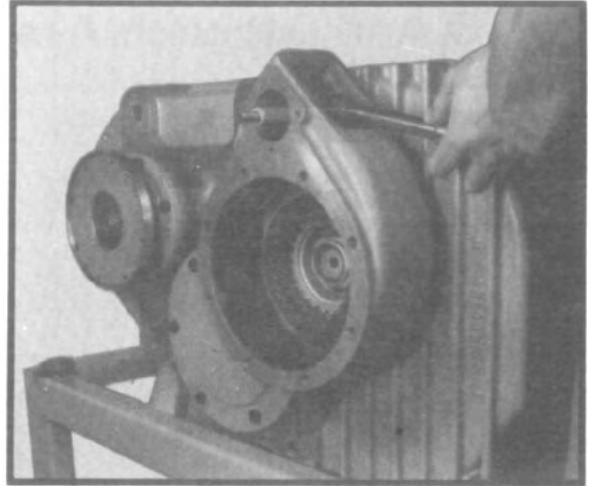

Fig. 177

5. Install o-rings in adapter tube and insert adapter tube into PTO/declutch housing. (See fig. 178)

6. Place small o-ring over threads of shift shaft. (See fig. 179.)
7. Place stop ring over shift shaft and place spring over end of shift shaft.

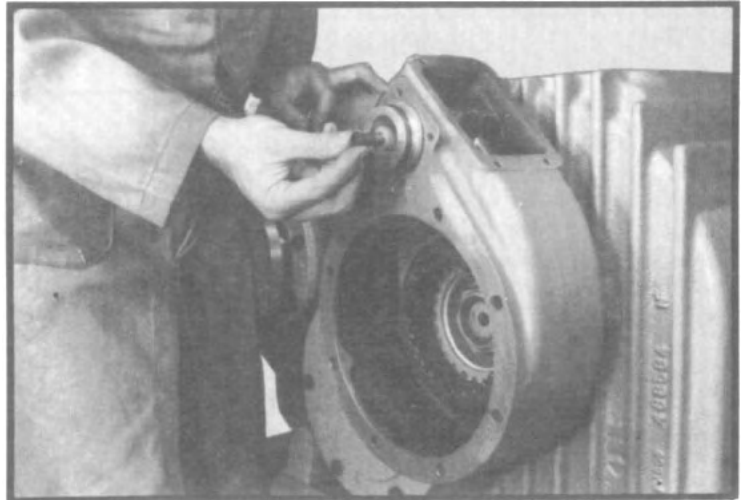

Fig. 179

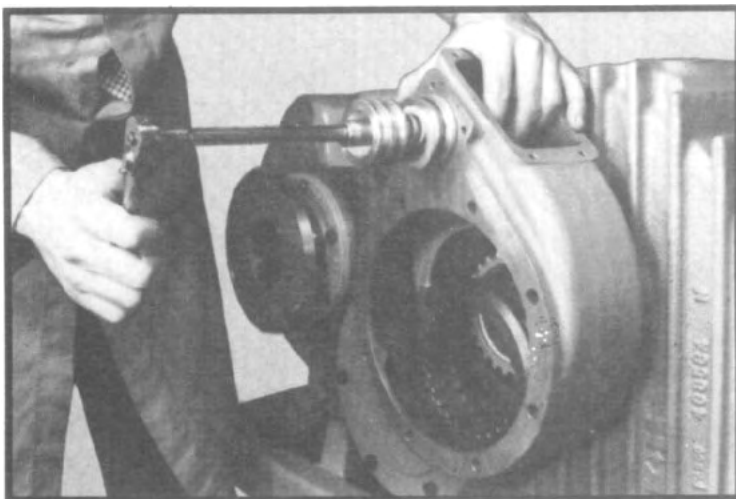

Fig. 180

8. Place piston over threads of shift shaft (depressing spring) with shallower of two grooves facing towards shaft. (See fig. 167)
9. Install shift shaft nut and washer. Tighten nut to correct torque. (See fig. 180.)

VII. TRANSFER CASE ASSEMBLY

10. Place an oil soaked felt wiper in shallow groove on piston and an o-ring into deep groove. (See fig. 181 and fig 167.)
11. Coat the shift cylinder tube lightly with gear lubricant. Place cylinder tube over piston and over adapter tube. (Use care not to cut or displace o-rings.)
12. Install o-ring in shift cylinder cap.

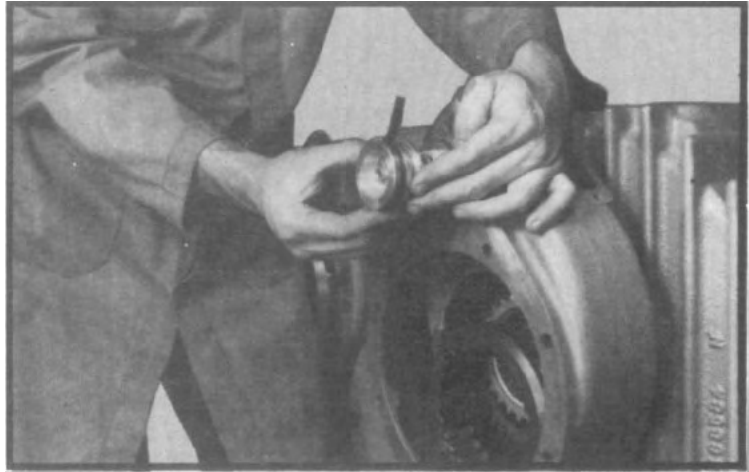
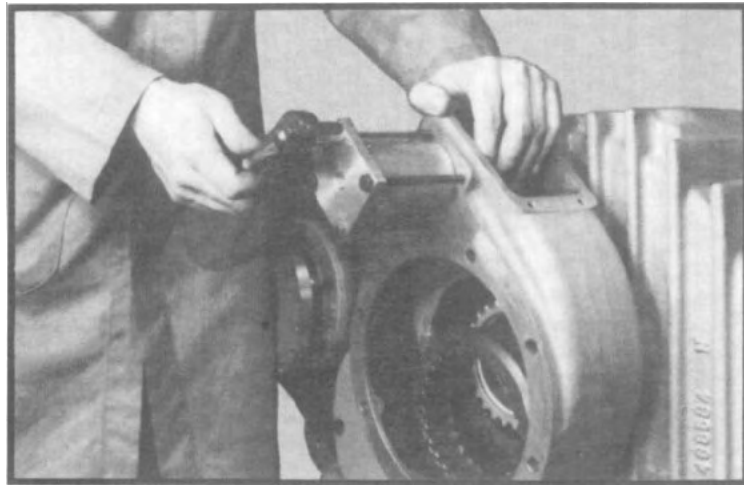

Fig. 181



13. Install cylinder cap on cylinder tube with four long capscrews, tightening to correct torque. Tighten capscrews evenly to prevent cocking the cylinder cap, (See fig. 182)

14. Apply cover plate gasket to PTO/declutch housing.

Fig. 182

15. Install cover plate with four cap-screws, tightening to correct torque. (See fig. 183)
16. Insert plunger into indicator switch hole.
17. Install indicator switch, shimming with copper washers as necessary for proper operation. Check with continuity checker.

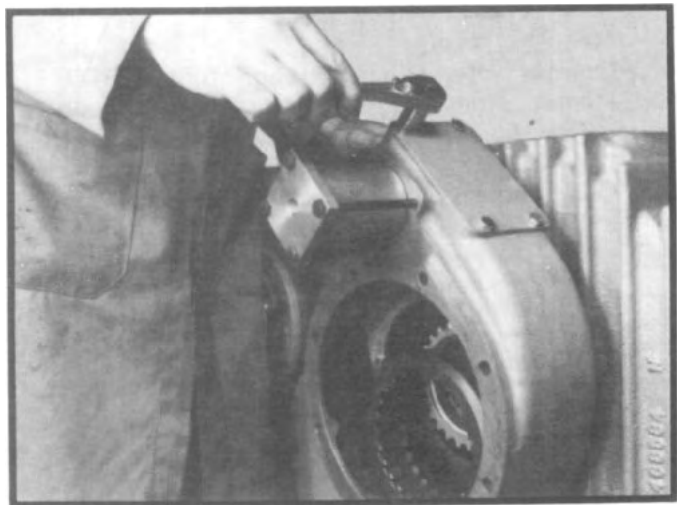

Fig. 183



Fig. 184

18. Press bearing cups into PTO/declutch carrier in an arbor press. (See fig. 184)

VII. TRANSFER CASE ASSEMBLY

19. Install snap ring on output shaft and slide clutch gear onto output shaft. (See fig. 185.)

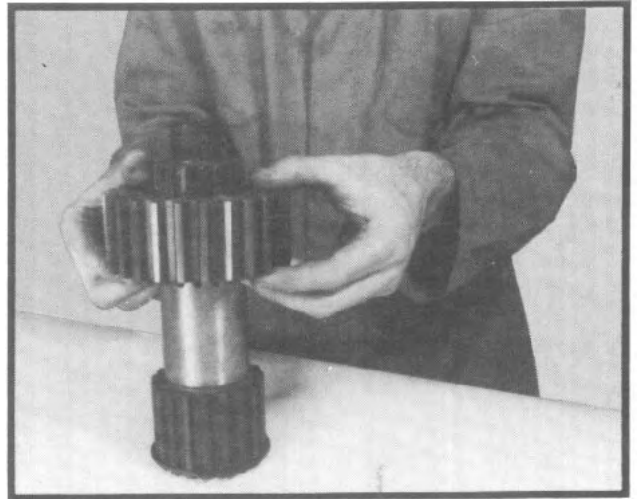

Fig. 185

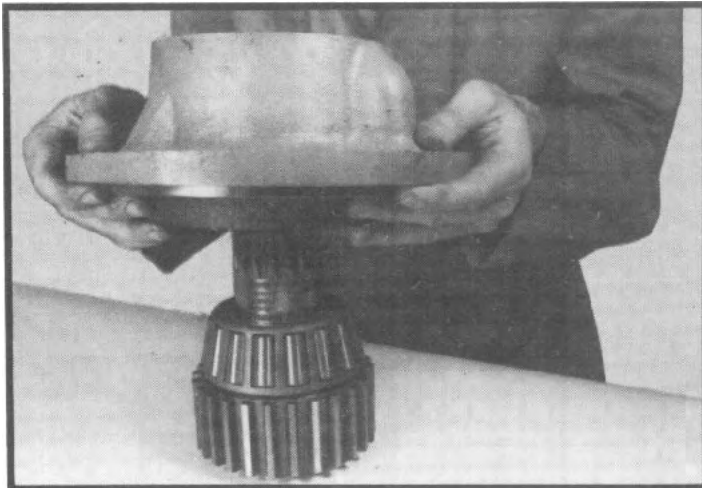

Fig. 186

21. Place end play spacer through front of PTO/declutch carrier and on top on inner roller bearing. (See fig. 187.)
22. Press outer roller bearing onto output shaft and into PTO/declutch carrier. (See fig. 188.)

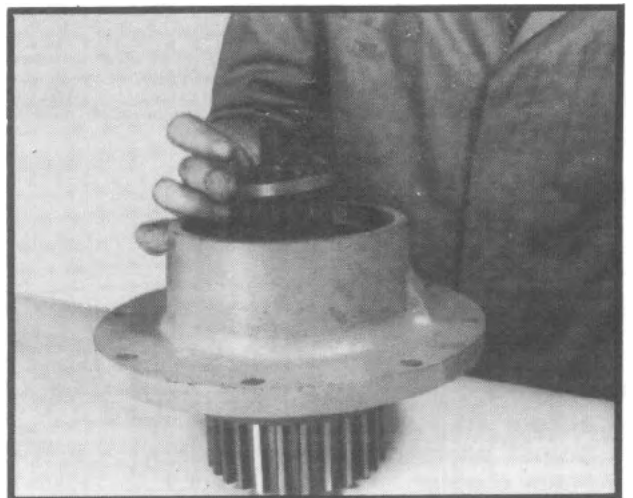

Fig. 187

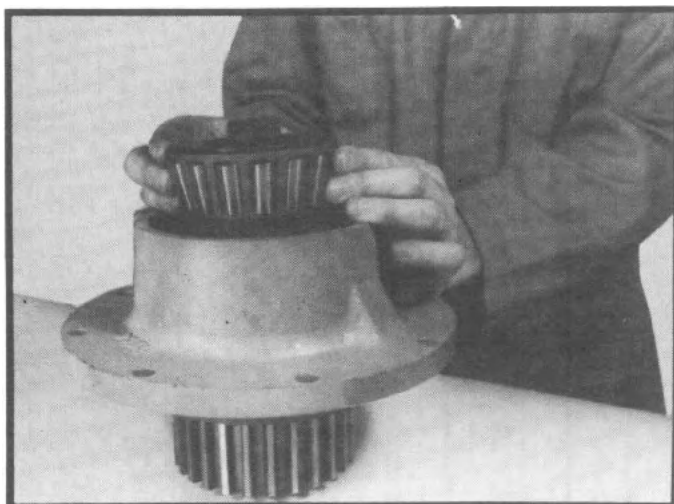

Fig. 188

20. Press roller bearing onto output shaft insert PTO/declutch carrier onto output shaft. (See fig. 186)

Note: The declutch and PTO output shaft bearings need no adjustment as the bearing spacer is factory selected for proper adjustment. If the bearings have been replaced, assemble the output shaft in its carrier and check the end play. If it is more than .006 inch or less than .003 inch, substitute a spacer with another thickness and re-check. Spacers of .313, .318, .323 and .328 inch thickness are available. Use a .323 spacer to start. Experience has shown that 75% of the time this value will give the correct end play on the first trial.

VII. TRANSFER CASE ASSEMBLY

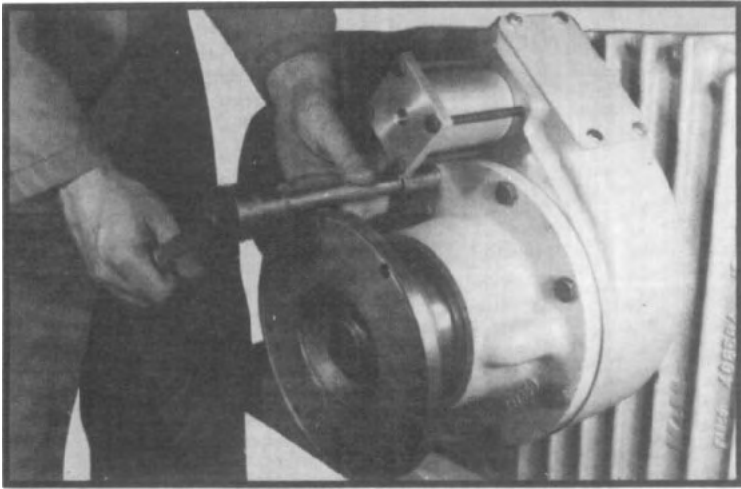

Fig. 189

23. Install drive flange seal with an appropriate driver.
24. Coat the flange hub with gear lubricant. Install drive flange onto output shaft with nut and lockwasher. Tighten nut to correct torque.
25. Apply gasket to PTO/declutch housing and install declutch carrier with eight capscrews, tightening to correct torque. PTO/declutch carrier must be installed so oil port is facing toward the bottom of the case. (See fig. 189.)

G. Direct Pump Drive Assembly

1. Refer to Section VII-F and follow steps 1 through 17.
2. Install pump drive gear on pump shaft with one-eighth inch clearance between face of gear hub and pump mounting flange. Tighten setscrews securely.
3. Apply gasket to declutch housing and install mounting plate on declutch housing with eight capscrews, tightening to correct torque.
4. Apply gasket to mounting plate and install pump on mounting plate with four capscrews, tightening to correct torque.

H. Shift Shaft Assembly

OLD STYLE:

1. Install shift shaft cap and gasket with four capscrews, tightening to correct torque. (See fig. 190.)

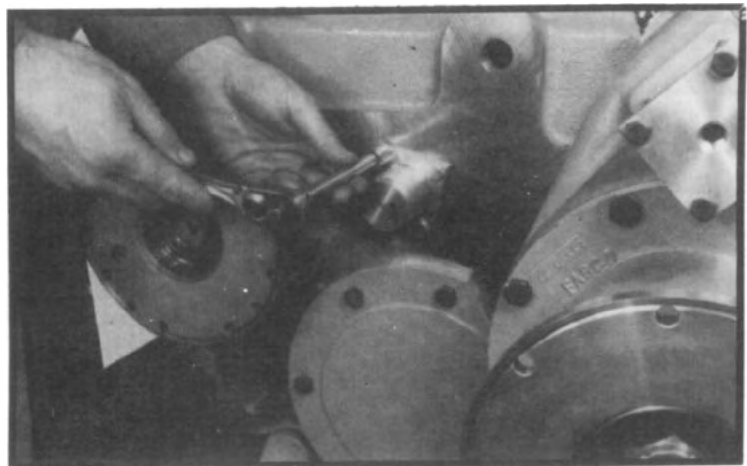

Fig. 190

VII. TRANSFER CASE ASSEMBLY

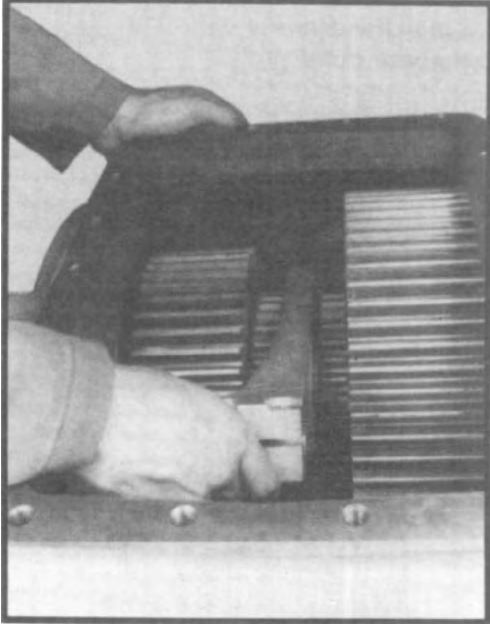

Fig. 191 (old style shown)

OLD STYLE:

2. Position shift fork on clutch gear so that clamping screws will point upwards. (See fig. 191.)

NEW STYLE:

Position shift fork so that flat machined side faces underdrive gear (front). (See fig. 191)

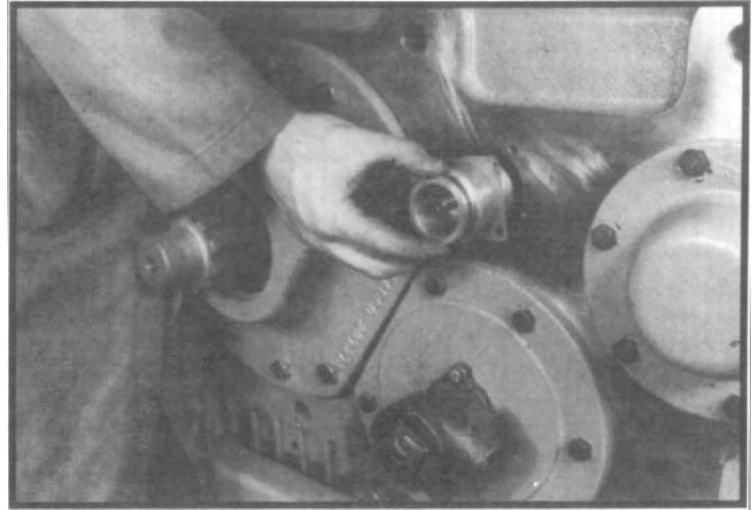

Fig. 192

NEW STYLE:

3. Place a small amount of oil on shaft, install shaft through large hole in housing. Thread jam nut onto shaft threads from inside housing and screw shaft into fork. Use a hex wrench to turn shaft. (See fig. 197A.)

4. Install o-ring in adapter tube and insert tube and gasket into housing over shaft. (See fig. 192.)

5. Place small o-ring over threaded end of shift shaft. (See fig. '193.)

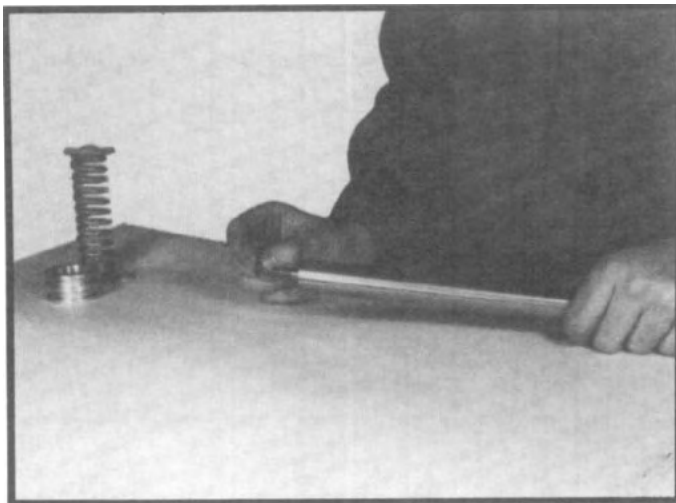

Fig. 193

6. Place spring and stop ring over shaft and place piston over shift shaft with the shallower of the two grooves toward shaft. (See fig. 194 and fig. 167.)

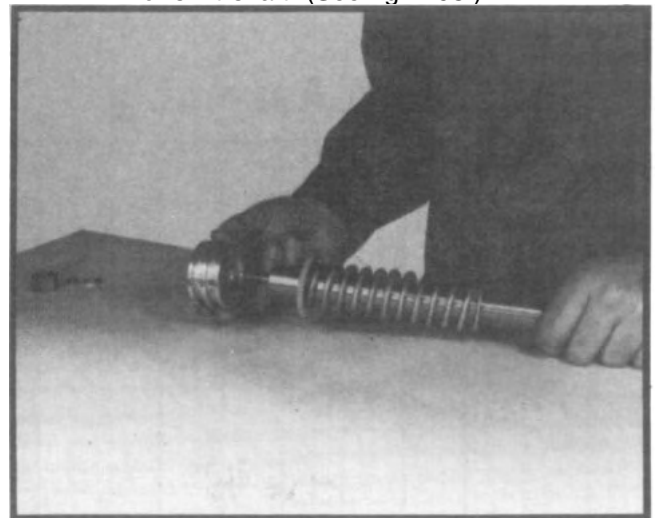

Fig. 194

7. Install shift shaft nut and washer, tightening nut finger tight.

VII. TRANSFER CASE ASSEMBLY

OLD STYLE:

8. Place a small amount of oil on shaft and install shift fork, sliding shaft into cap on opposite side of housing. (See fig. 196.) Align two grooves with clamping screw holes and install shift fork clamping screws. Tighten shift fork clamping screws to correct torque. (See fig. 197.) Secure clamp screws with lockwire.

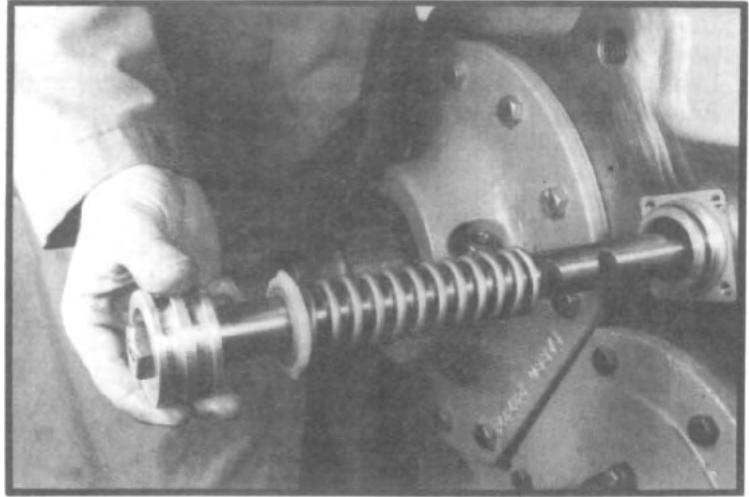

(old style) Fig. 196

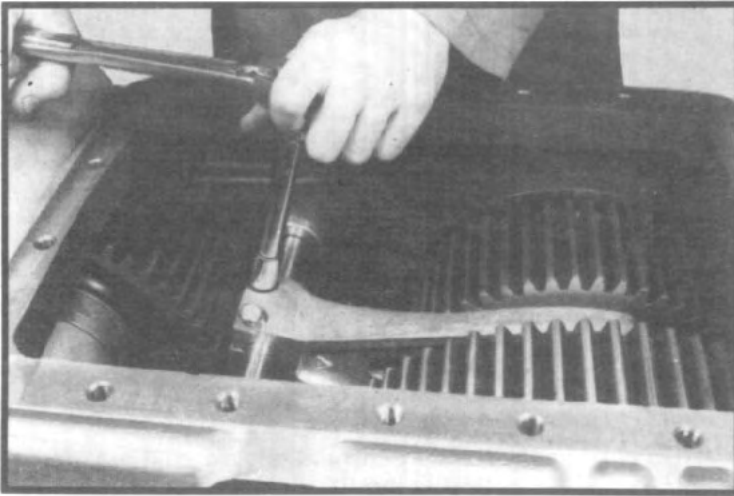

Fig. 197 (old style)

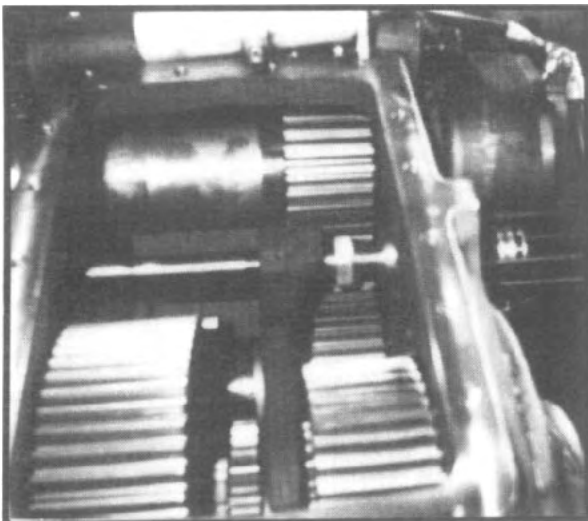

Fig. 197A (new style)

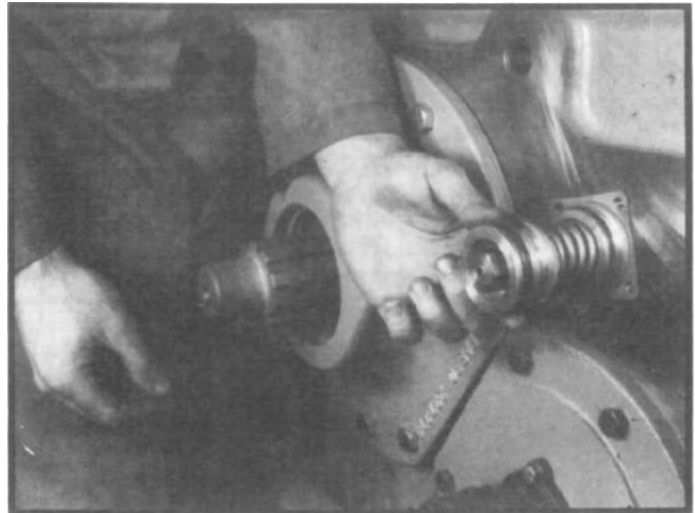

Fig. 198

9. Place an oil soaked felt wiper in shallow groove on piston and an o-ring into deep groove. (See fig. 198 and 167.) Tighten shift shaft nut to correct torque. Install and tighten set screw, if so equipped.

VII. TRANSFER CASE ASSEMBLY

10. Coat the shift cylinder tube lightly with gear lubricant, install cylinder tube over piston and seat against adapter tube. (See fig. 199.)
11. If transfer case is not equipped with neutral feature for PTO operation, skip to step 18.

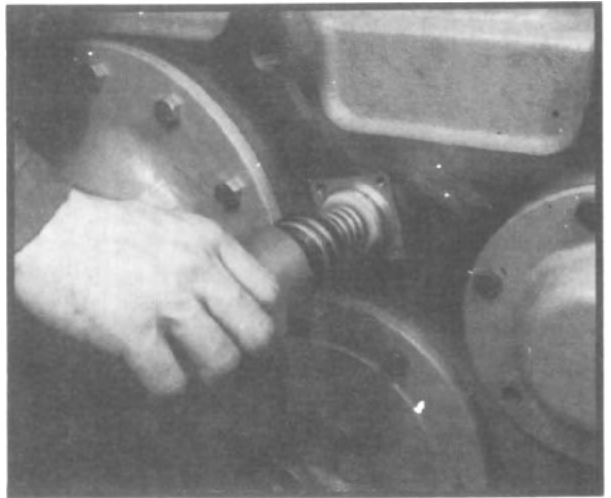

Fig. 199

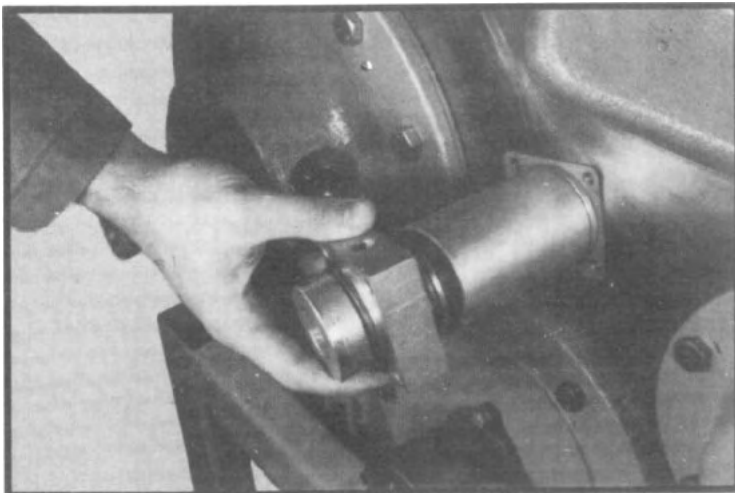

Fig. 200

12. Install o-rings in neutral adapter tube and insert tube into cylinder. (See fig. 200)
13. Place small o-ring over threaded end of neutral shift shaft.
14. Place piston over neutral shaft with the shallower of the two grooves toward shaft. (See fig. 167)
15. Install neutral shaft nut and washer, tightening to correct torque.

16. Place an oil soaked felt wiper in shallow groove on piston and o-ring in the deep groove. Place stop ring over neutral shaft. (See fig. 167)
17. Coat cylinder tube lightly with gear lubricant, install cylinder tube over piston and seat against neutral adapter tube. (See fig. 201)

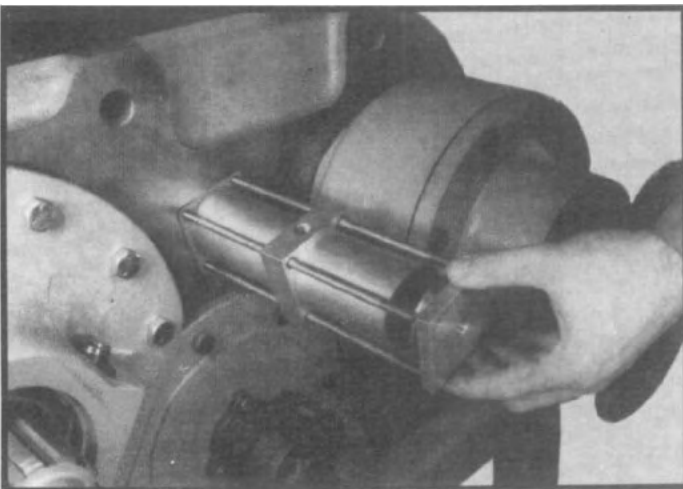

Fig. 202

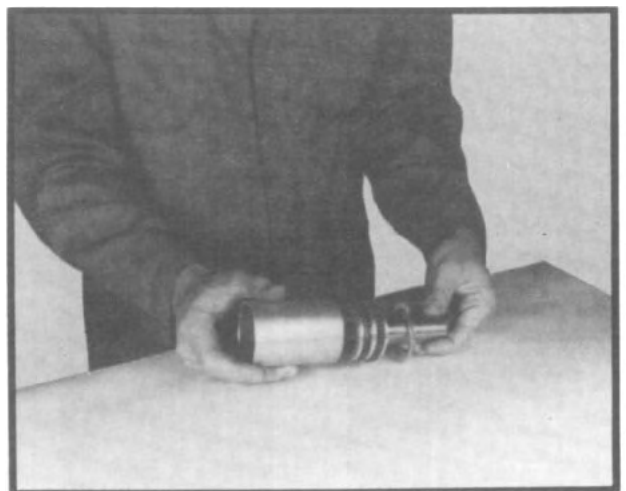

Fig. 201

18. Install o-ring in shift cylinder cap and install shift cap into the cylinder tube. Secure assembly with capscrews or studs with nuts, tightening to correct torque. (See fig. 202 and fig. 203.)

VII. TRANSFER CASE ASSEMBLY

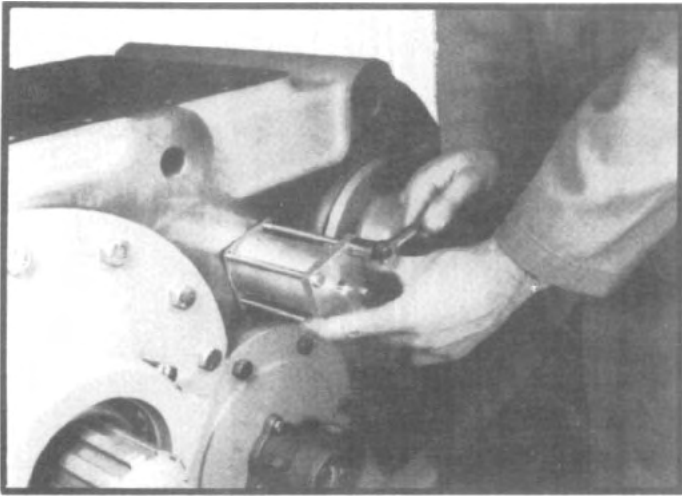

Fig. 102

NEW STYLE:

19. Using a hex wrench to screw shaft in or out, adjust all three positions, high-neutral-underdrive (high-underdrive on cases without neutral) to give a centered neutral and approximately equal engagement at both ends of the shift. Use shop air pressure to operate the shifts. Tighten the jam nut to correct torque and install rear cap and gasket with four capscrews. (See fig. 197A.)

I. Oil Pump Assembly

1. Install rotor in pump body.
2. Apply gasket to cover.
3. Place idler gear on pin in cover assembly.
4. Place cover assembly with idler gear on pump housing. Use care to align matching marks for proper location. Insure cover notch is in same position as when removed.
5. Install cover plate capscrews securely. Pull down gradually and alternate from a screw on one side to one on the opposite side.
6. Install and tighten housing plug with appropriate spanner wrench.
7. Check pump for free rotation by turning shaft with a suitable wrench. (Shaft should turn freely without binding.) Rotor end play of .003-.010 can be obtained by adding or taking out cover plate shims.

J. Final Assembly

1. Install cover plate and gasket with capscrews and lockwashers, tightening to correct torque. (See fig. 204.)



2. Install oil drain plug.
3. Install temperature sensor if vehicle is so equipped.
4. Prior to plumbing, prime oil pump with oil can.
5. Connect oil pump lines.
6. Fill filter sump prior to running.

VIII. TORQUE SPECIFICATIONS

LOCATION	SIZE	GRADE	TORQUE (FT. LBS.)
Transfer case cover bolts	7/16-14 × 1-1/4	5	35
Upper shaft front seal carrier bolts	7/16-14 × 1-1/4	5	35
Upper shaft rear cover bolts	7/16-14 × 1-1/4	5	35
Intermediate shaft front/rear cover bolts	7/16-14 × 1-1/4	5	35
Oil pump bolts	1/4-20 × 1	5	5
Lower shaft rear output carrier bolts	1/2-13 × 1-1/2	5	55
PTO/Declutch/Lockout housing to transfer case housing bolts	7/16-14 × 2-1/4	5	35
Front drive declutch gear nut	1-1/2-18	—	400
Front drive yoke or flange nut	1-1/4-18	—	300
Rear drive yoke or flange nut	1-3/4-16	—	400
Input yoke or flange nut	1-1/2-18	—	400
PTO/Declutch/Lockout inspection cover bolts	1/4-20 × 1/2	5	5
PTO/Declutch carrier bolts	7/16-14 × 1-1/4	5	35
PTO shift cylinder capscrews	1/4-20 × 3-3/4	5	15
Declutch/Lockout shift cylinder capscrews	1/4-20 × 3-3/4	5	15
High-Low shift cylinder capscrews	1/4-20 × 4-1/2	5	15
H-N-U Shift cylinder stud nuts	1/4-20 × 4-1/2	—	15
PTO yoke or companion flange nut	1-1/4-18	—	300
Shift shaft cap capscrews	1/4-20 × 3/4	5	15
PTO/Declutch/Lockout shift fork clamping bolts	7/16-20 × 1-1/2	5	35
Shift shaft flexlock nuts (high-low, H-N-U, PTO, declutch, and lockout)	3/8-24	—	15
H-N-U shifter shaft inner piston nut	3/8-24	—	15
Shift Fork Jamnut (new style)	1-1/4-12	—	250

General: Oil threads or coat with Permatex #2. (Refer to VII-A-2 on page 38)

VIII. TORQUE SPECIFICATIONS

50/50 Proportional Differential

LOCATION	SIZE	GRADE	TORQUE (FT. LBS.)
Differential carrier cap stud nuts	7/16-14	—	40
Lower shaft rear seal carrier bolts	7/16-14 × 2¾	5	35
Rear face plate to transfer case mounting bolts	½-13 × 1½	5	55
Proportional differential case bolts	⅝-18 × 5	5	130
Lower shaft clutch gear nut	N-13	—	150
Locknut bearing carrier to lockout housing bolts	7/16-14 × 1¼	5	35
Lower shaft front seal carrier bolts	7/16-14 × 1¼	5	35

26/74 Proportional Differential

LOCATION	SIZE	GRADE	TORQUE (FT. LBS.)
Planetary carrier cap bolts	7/16-14 × 7	5	35
Lower shaft planetary carrier nut	AN-15	—	150
Lower shaft rear output shaft to internal gear bolts	⅜-16 × 1½	5	40
Lower shaft rear seal carrier bolts	7/16-14 × 2¾	5	35
Rear face plate to transfer case mounting bolts	½-13 × 1½	5	55
Lower shaft clutch gear nut	N-13	—	150
Lower shaft front seal carrier bolts	7/16-14 × 1¼	5	35
Lockout bearing carrier to lockout housing bolts	7/16-14 × 1¼	5	35

IX. TOOL REFERENCE

Note: Prints are available from the Kelsey-Hayes Co., FABCO Division to make these tools—contact FABCO engineering and request prints by drawing number.

NAME	WHERE USED	ILLUSTRATION	FABCO PART NO.	DRAWING NO.
SOCKET WRENCH	Lower shaft clutch gear nut (50/50 differential and 27/74 planetary assemblies	Fig. 218	866 368	866 368
SOCKET WRENCH	Lower shaft planetary nut 26/74 differential assembly	Fig. 217	866 367	866 367
TC-140 ASSEMBLY STAND	Transfer case disassembly and assembly	Fig. 219	350 078	350 078
INSTALLATION TOOL	Intermediate shaft assembly	Fig. 83	866 420	866 420

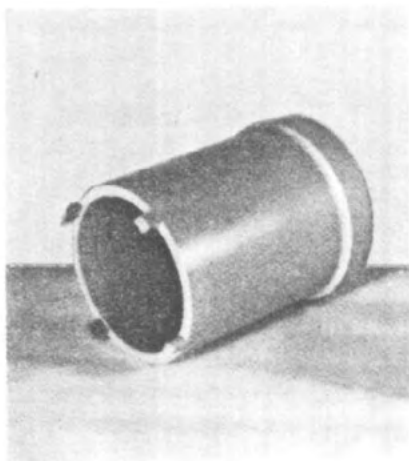

fig. 217

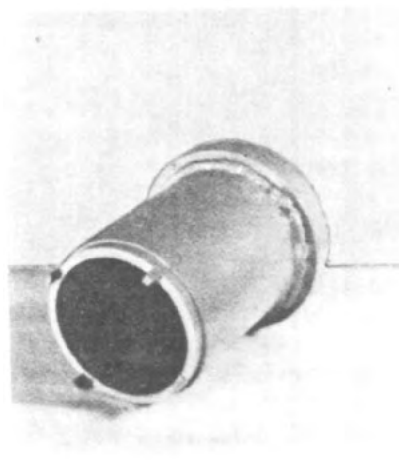

fig. 218

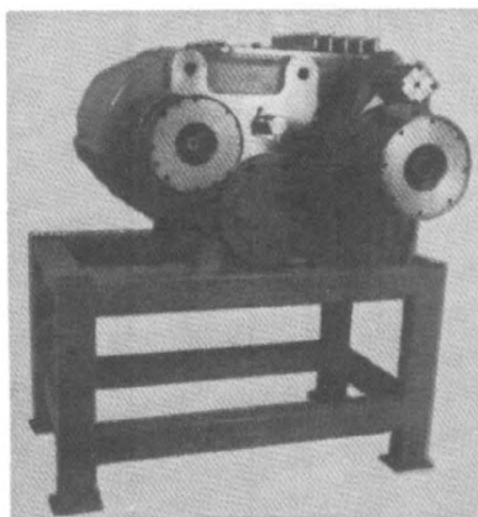

fig. 219