



Eaton Fuller FO-16E313A-VHP Transmission Parts Manual

This is Eaton Fuller FO-16E313A-VHP Transmission parts manual brought to you by Pro Gear and Transmission to assist you identifying the parts for your Eaton / Fuller transmission unit.

If you need any assistance identifying the correct Eaton / Fuller unit for your truck and equipment, contact your Eaton replacement parts specialists at Pro Gear and Transmission.

Pro Gear stocks every part for your Eaton transmission including: Valve Assemblies, Synchronizers, Yoke Assemblies, O-Ring Kits, Drive Gears, Gaskets, Bearing and Seal Kits, and much more.

Pro Gear and Transmission has same day shipping and thousands of products in stock and ready to ship internationally for your next project.

For parts or service contact the Eaton transmission specialists at Pro Gear & Transmission, Inc.

 CALL US

 EMAIL US

 VISIT MODEL PAGE

 VISIT ONLINE STORE



Roadranger®

More time on the road®

Illustrated Parts List

FO-16E313A-VHP

November 2012

Contents

How To Use The Illustrated Parts List	3
AFTERMARKET TRANSMISSIONS.....	4
AUXILIARY DRIVE GEAR	5
CASE (AUX)	6
CASE (FRONT)	8
CONTROLLER ECU & HARNESS	11
COUNTERSHAFT & BRGS(AUX)	12
COUNTERSHAFT ASSY.....	13
ELECTRIC CLUTCH ACTUATOR	15
FILTER REGULATOR.....	16
HEAT EXCHANGER	17
INPUT SHAFT & DRIVE GEAR	18
INTEGRAL OIL PUMP	20
KITS & ASSEMBLIES	22
MAINSHAFT & SYNCHRO(AUX)	24
MAINSHAFT ASSY	26
OIL FILTER.....	28
RANGE CYLINDER.....	30
REVERSE IDLER	32
SHIFT BAR HOUSING	35
SHIFT CONTROLS.....	37
SPLITTER CYLINDER	39
X-Y SHIFTER MODULE	41

How To Use The Illustrated Parts List

The information contained in this document is subject to frequent updates. Therefore, for the latest information available, please visit the interactive Electronic Parts Catalog at www.roadranger.com/epc.

Model Designation or Nomenclature

- For information regarding Model Designation and Nomenclature, visit www.roadranger.com.

Kits and Assemblies (K/A's)

- Kits and Assemblies contain groups of individual or assembled parts developed for optimal replacement or repair of a service problem.
- Kits and Assemblies are shown with applicable parts groupings in the parts listings.

Identifying Kits and Assemblies

A- Part numbers beginning with the letter 'A' are pre-assembled Production Assemblies

K- Part numbers beginning with the letter 'K' are kits that are not assembled

S- Part numbers beginning with the letter 'S' are pre-assembled Service Assemblies

- Note: Some Production Assemblies do not begin with a letter prefix (Midrange only).

Illustrations

- Illustrations show parts in assembly groups.
- Item numbers on illustrations correspond with parts listings on pages adjacent to the illustration.
- Notes are included on illustrations where additional information is needed.

Parts Listing

Parts listings are defined by parts groupings and are broken down by service assemblies. Parts listings identify a part for servicing with the following categories

- **Item Number** - corresponding with numbers on illustrations for part identification.
- **Current Part** - identifies part as it is available for service.
- **Description** - specifies part name or description.
- **Replaced Part** - quantity quantity required for assembly.
- **Quantity** - defines unique characteristics or requirements.
- **Notes** - indicates Kits or Assemblies that contain a particular part.
- **Kits/Assy's Where Used**



BACKED BY
Roadranger
SUPPORT



UltraShift Plus Transmission

AFTMKT 09U-12

Generic Illustration - Not specific to part numbers listed below

AFTERMARKET TRANSMISSIONS

Item	Current Part	Description	Replaced Part	Qty.	Notes	Kits/Assys Where Needed
	TA-G47-12X	FO-16E313A-VHP EXCHANGE UNIT		1	WITH INTERNAL PUMP - NO CLUTCH HOUSING	
	TN-G47-12R	FO-16E313A-VHP REMAN TRANS		1	WITH INTERNAL PUMP	
	TN-G47-12X	FO-16E313A-VHP EXCHANGE UNIT		1	WITH INTERNAL PUMP - NO CLUTCH HOUSING	

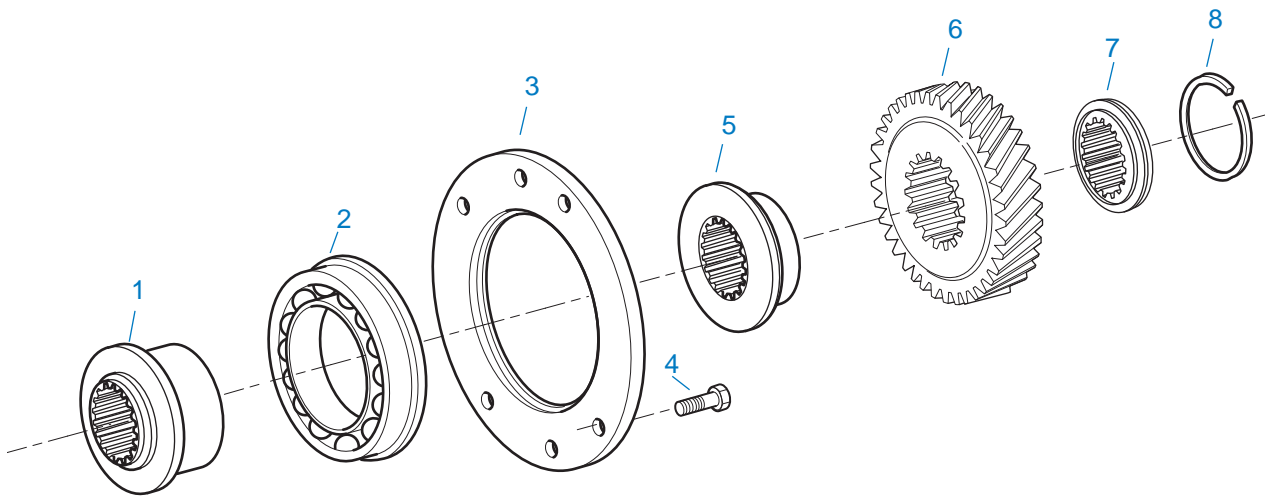

10484-6-93

AUXILIARY DRIVE GEAR

Item	Current Part	Description	Replaced Part	Qty.	Notes	Kits/Assys Where Needed
1	4306314	SPACER		1		
2	5566510-BOX	BEARING	5566510	1		K-3941
3	4304497	RETAINER		1		
4	X-8-680	CAPSCREW		6	3/8"-16X1-1/2"	
5	4304500	SPACER		1		
6	4303825	AUXILIARY DRIVE GEAR		1		
7	4303185	WASHER	4300901	1		
8	4301254	SNAP RING		1		K-3941,K-4140

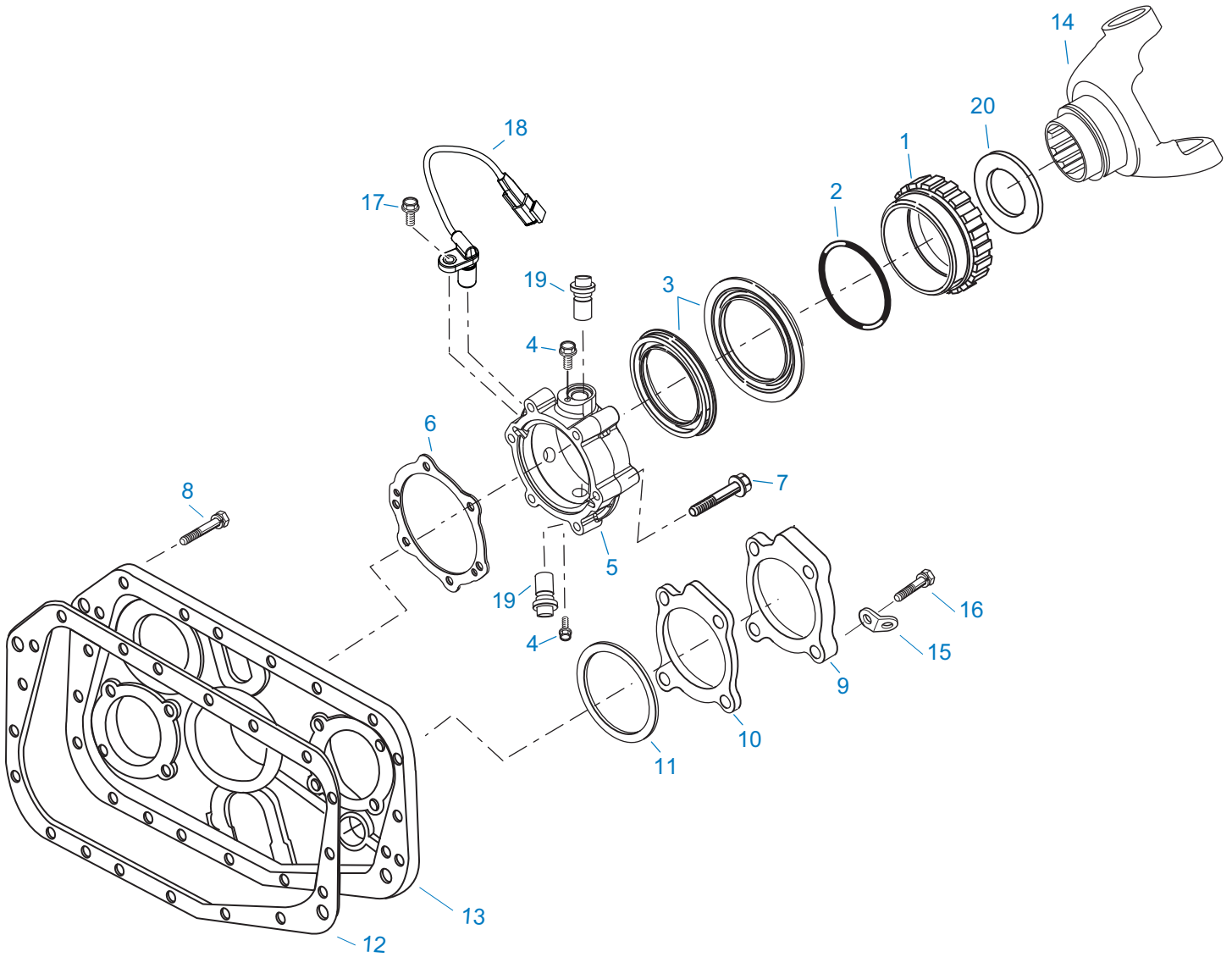

11407-11-10

CASE (AUX)

Item	Current Part	Description	Replaced Part	Qty.	Notes	Kits/Assys Where Needed
1	S-2501	SPEEDO ROTOR ASSY	4302242	1	MAGNETIC	
2	5568511	-O- RING		1		K-2918,S-2501,S-3106
3	K-2918	OIL SEAL KIT	4302322 4302323	1	"FOR MAGNETIC COVER"	K-3941
4	X-8-0801M	CAPSCREW		2	M8 X 1.25 X 12MM	S-3106
5	S-3106	REAR BEARING COVER ASSY	4306498	1		
6	1009551	GASKET - RED EDGE MOLDED		1		K-2918,K-3939,S-3106

Item	Current Part	Description	Replaced Part	Qty.	Notes	Kits/Assys Where Needed
7	X-8L-611	CAPSCREW		4	3/8"-16X3-1/4"	S-3106
7	X-8L-614	CAPSCREW		2	3/8"-16X2"	S-3106
8	X-8L-602	CAPSCREW		16	3/8"-16X1-1/2"	
8	X-8L-614	CAPSCREW		2	3/8"-16X2"	S-3106
8	X-8L-616	CAPSCREW	X 8 616	1	3/8"-16X2-3/4"	
9	4302320	COVER	21346	2		
10	4305978	GASKET	4302246	2		K-3547,K-3939
11	K-2805	SHIM KIT	21452 K - 2106	1		K-3941
12	14335	GASKET		1		K-3939
13	4306307	REAR HOUSING		1		
14	5505543	YOKE-1710 HALF ROUND		1		
15	20815	LIFTING EYE	17105	2		
16	X-8L-600	CAPSCREW		8	3/8"-16X1"	K-4012
17	X-8C-409	CAPSCREW		1	1/4"-20X5/8"	K-3938,K-3947,S-3111
18	K-3947	DIRECTIONAL SPEED SENSOR KIT	4306497	1		
19	K-3523	SPEEDO PLUG KIT	4302707	2		
20	4304653	SHIELD		1		S-3106

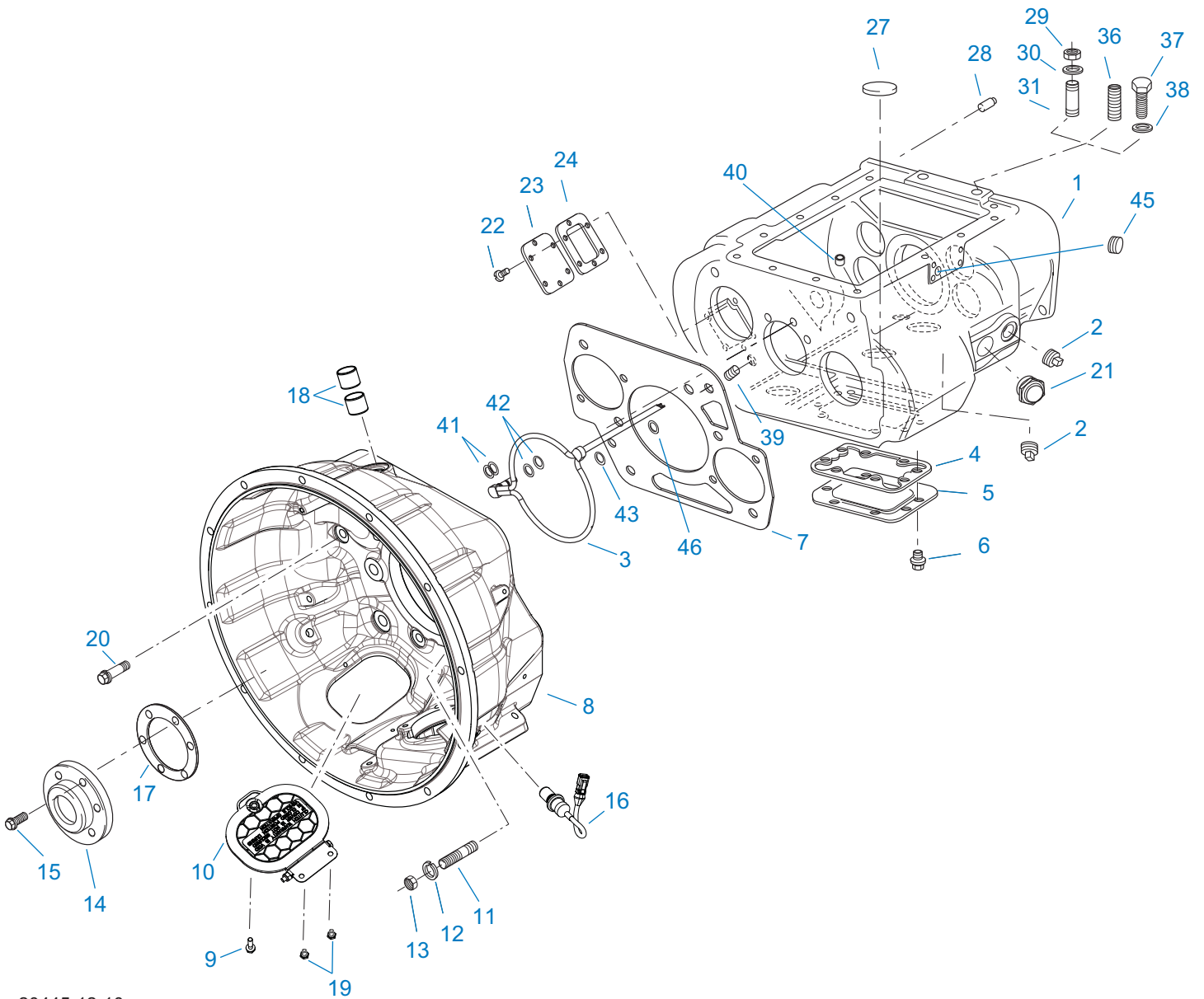

20445-12-10

CASE (FRONT)

Item	Current Part	Description	Replaced Part	Qty.	Notes	Kits/Assys Where Needed
1	S-3121	CASE ASSY	4306036	1		
2	4304023	PLUG	4303747	2	1-1/16" MAGNETIC, O-RING INCLUDED	
3	A-7471	EXTENDED LUBE TUBE ASSY	4305393	1		
4	4305310	GASKET	4302810	1		K-3939
5	4302809	PTO COVER	16596 ,4300571	1		
6	X-8-725	CAPSCREW	X 8 724	8	7/16"-14X7/8"	

Item	Current Part	Description	Replaced Part	Qty.	Notes	Kits/Assys Where Needed
7	4306584	CLUTCH HOUSING GASKET	4304815,4305668	1		K-3939,K-4145
8	A-8117	CLUTCH HOUSING ASSY	4307000	1	STANDARD	
8	A-8118	CLUTCH HOUSING ASSY, NODAL	4306906	1	NODAL	
9	X-8C-401	CAPSCREW		1	1/4"-20X1-1/8"	K-4088
10	K-4088	HAND HOLE COVER KIT	4306459	1		
11	4306583	STUD	5966	4	FOR CLUTCH HOUSING	
11	5577005	STUD		2	(.625 X 3.75), FOR LCIB	
12	X-10-1005	WASHER	X 3 1000 ,X10 1000 ,X10 1004	6	1.23 X 6.60	K-4134
13	X-1-1012	HEX NUT	X-1-1005	6	.625-18	K-4134
14	4308012	FRONT BEARING COVER		1	MUST BE USED WITH 4308011 INPUT SHAFT	K-4144,K-4145
14	K-4144	INPUT SHAFT REPLACEMENT KIT	4306466	1		
15	X-8L-604	CAPSCREW		6	3/8"-16X1-1/4"	K-3547
16	K-3938	SPEED SENSOR KIT		1		
17	14311	GASKET		1		K-3939,K-4142
18	12815	BUSHING		2		K-4036
19	X-8-423	CAPSCREW		2	1/4"-20X1/2"	K-4088
20	X-8C-830	HEX HEAD SCREW/WASHER ASSY	X-8C-826	6	.500-13 X 1.490	
21	4305550	SIGHT PLUG (1-5/8)	4304123	1		
22	X-8-686	CAPSCREW		6	3/8"-16X3/4"	
23	14575	PTO COVER	4302254	1		
24	4305309	GASKET	1684	1		K-3939
27	14373	MAGNET		3		S-3121
28	18128	PIN		2		
29	X-1-1012	HEX NUT		2	.625-18	K-4134
30	X-10-1005	WASHER	X 3 1000 ,X10 1000 ,X10 1004	2	1.23 X 6.60	K-4134
31	14554	STUD	1632 ,6579	2	5/8" X 2-3/16"	
36	23104	PLUG	1712	2		
37	X-8-1005	CAPSCREW		2	5/8"-11X1-1/4"	
38	20814	SPACER		2		

Item	Current Part	Description	Replaced Part	Qty.	Notes	Kits/Assys Where Needed
39	X-12-802	PIPE PLUG	X12 800	1	1/2"	
40	691447	PIN		1		
41	13835	-O- RING		2		
42	13653	-O- RING		2		K-2908,K-4005
43	5568544	-O- RING		1		
45	X-12-1212	PIPE PLUG		1		
46	13834	-O- RING		1		

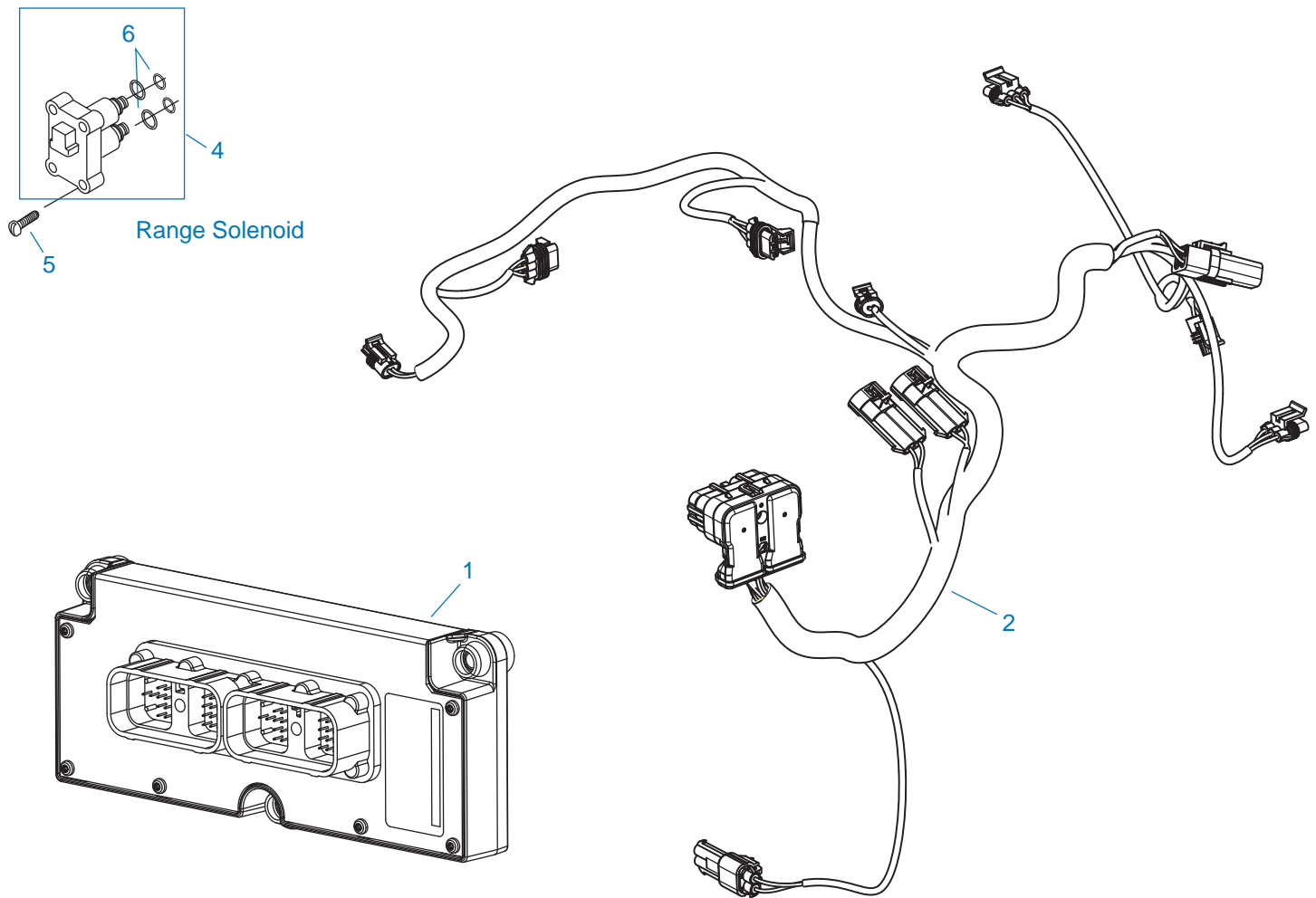

20322-10-05

CONTROLLER ECU & HARNESS

Item	Current Part	Description	Replaced Part	Qty.	Notes	Kits/Assys Where Needed
1	K-4139	ECU ASSEMBLY KIT (VHP)		1		
2	K-3984	TRANSMISSION HARNESS KIT		1		
4	K-3682	RANGE/SPLITTER VALVE KIT	5561801 ,5561804 ,K - 2907	1		
5	X-8-264	HEX FLANGE HEAD SCREW	X 8 259	4	#10-24 X 1 1/4	
6	K-2908	-O- RING KIT		1	FOR SOLENOID VALVE	

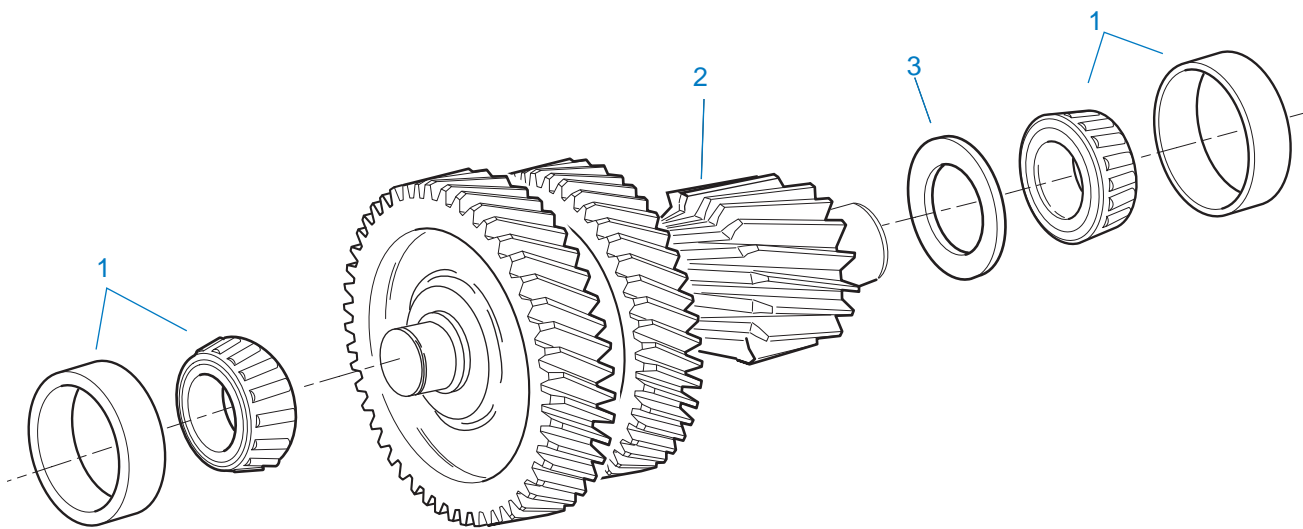

10444-5/93 CS Helical

COUNTERSHAFT & BRGS(AUX)

Item	Current Part	Description	Replaced Part	Qty.	Notes	Kits/Assys Where Needed
1	4301851-BOX	BEARING	4301851	4		K-3941
2	K-3220	COUNTERSHAFT REPLT KIT	4301792 ,4301793 ,A - 6187 ,A - 6602 ,A - 6603	2		
3	4303124	SPACER				
	2		K-3220			

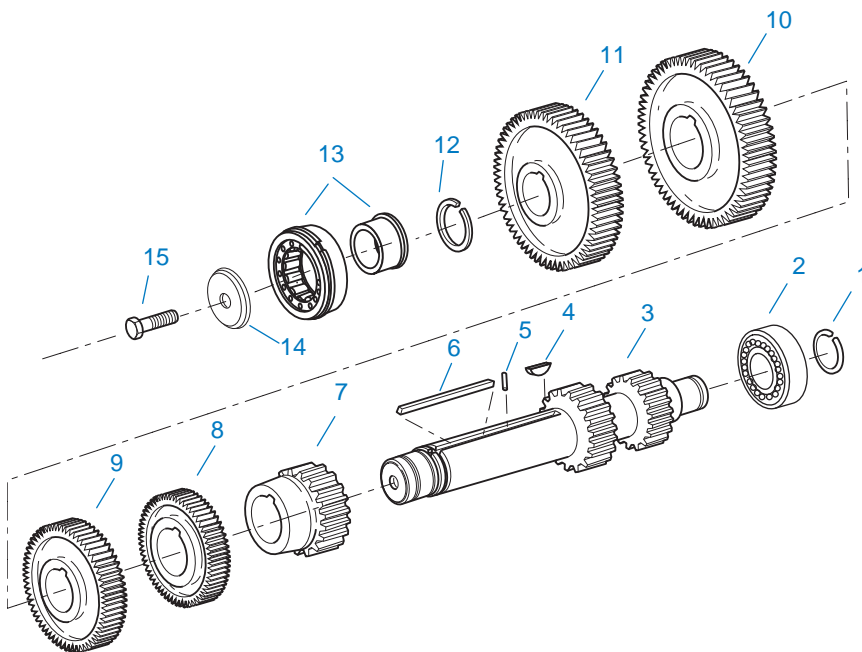

10364-11-96 CS/RT

COUNTERSHAFT ASSY

Item	Current Part	Description	Replaced Part	Qty.	Notes	Kits/Assys Where Needed
1	4302082	SNAP RING		2		K-3941,K-4140
2	4302712	BEARING		2		K-3941
3	K-2947	CNTRSHFT W/REV & LO	4302652	2		
4	X-6-E	KEY		2		
5	62511	ROLL PIN		2		
6	4304840	KEY	19673	2		
7	4304765	1ST GEAR-CNTRSHFT	4303702 ,4304520	2		
8	4300247	2ND GEAR-CNTRSHFT		2		
9	4303666	OD GEAR-CNTRSHFT	4304508 ,4304315	2		
10	15953	PTO GEAR - LOWER		1		
10	20840	PTO GEAR - UPPER	15952	1		
11	4302666	DRIVE GEAR-CNTRSHFT	4303697,4304512	2		
12	19198	SNAP RING		2		K-3941,K-4140
13	4304599	BEARING	4302677, 4304598, 4306332	2		K-3941
14	4304605	RETAINER	19548	2		
15	X-7-1005	CAPSCREW		2	5/8"-18X1-3/4"	

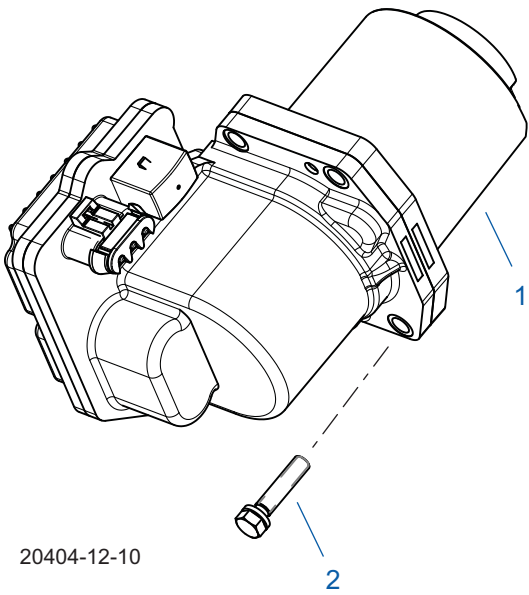

ELECTRIC CLUTCH ACTUATOR

Item	Current Part	Description	Replaced Part	Qty.	Notes	Kits/Assys Where Needed
0	K-4103	ECA SHIELD KIT	A-8155, A-8602	1	NOT PICTURED	
1	K-3936	ECA INLINE KIT		1		
2	X-8L-609	CAPSCREW		4		K-3936,K-4036

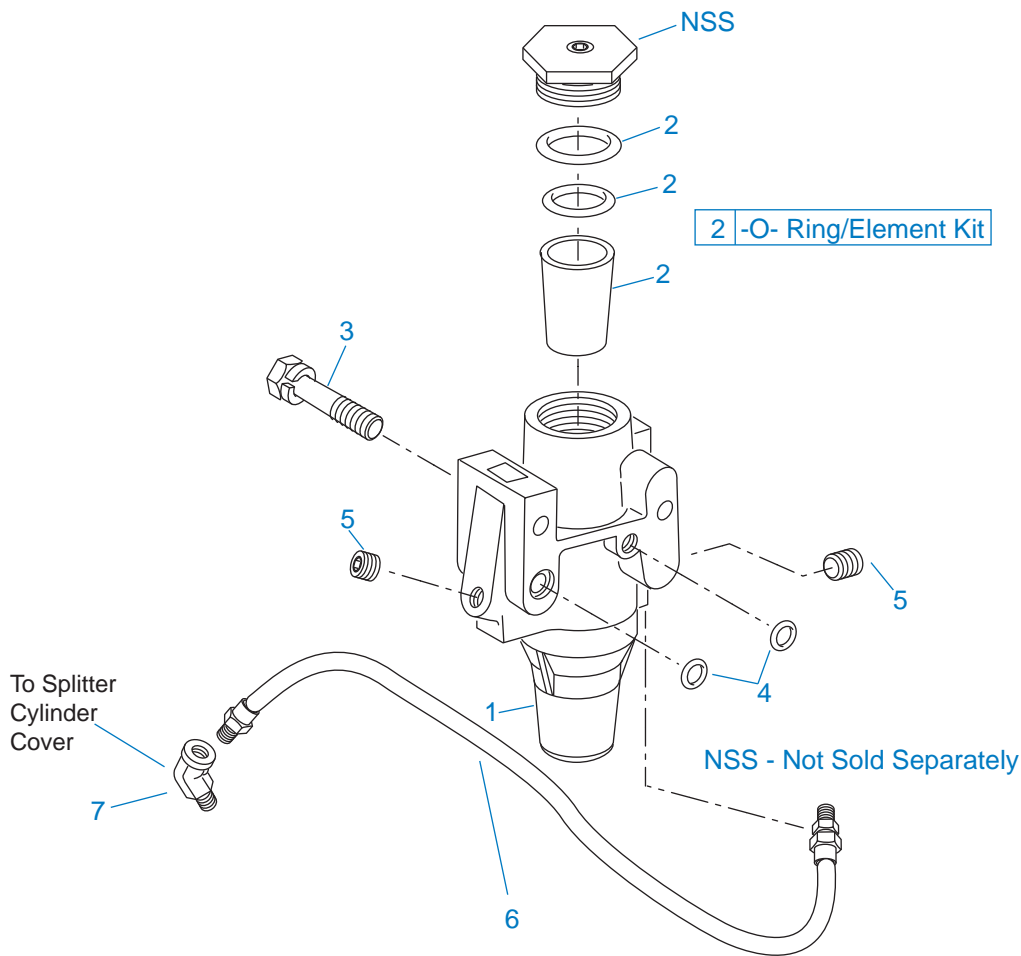

10131A-08-01

FILTER REGULATOR

Item	Current Part	Description	Replaced Part	Qty.	Notes	Kits/Assys Where Needed
1	K-2170	FILTER REG KIT	A - 5454	1		
2	K-1698	-O- RING/ELEMENT KIT		1	FOR FILTER REGULATOR	
3	X-8C-412	CAPSCREW	X 8S 412	2	1/4"-20X2-1/4"	
4	15114	-O- RING		2		K-2170,K-3365
5	X-12-208	PIPE PLUG		2	1/8" NPT	
6	55505	HOSE ASSY		1	16"	
7	12845	ELBOW		1	1/8"	K-3366

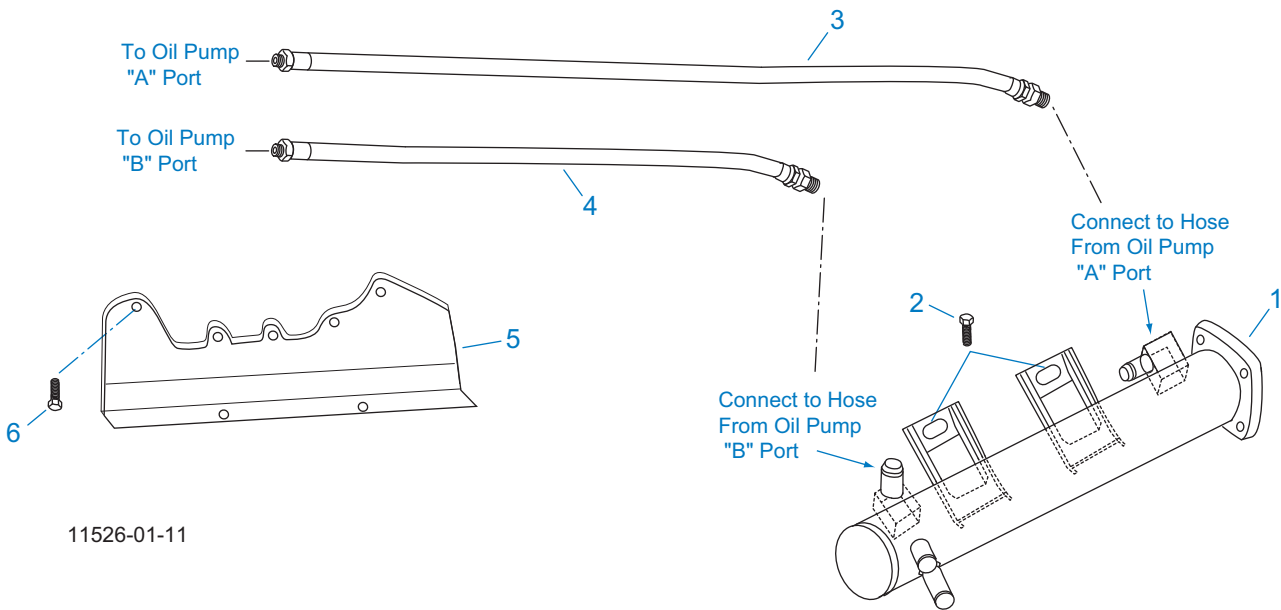

11526-01-11

HEAT EXCHANGER

Item	Current Part	Description	Replaced Part	Qty.	Notes	Kits/Assys Where Needed
1	5586645	HEAT EXCHANGER		1		
2	X-8C-604	CAPSCREW		2	3/8"-16X1-1/4"	
3	5588108	OIL HOSE ASSEMBLY	5586908	1	52"	
3	5588110	OIL HOSE ASSEMBLY		1	57.5", FOR USE WITH OIL FILTER	
4	5588107	OIL HOSE ASSEMBLY	5586907	1	45"	
4	5588111	OIL HOSE ASSEMBLY		1	50", FOR USE WITH OIL FILTER	
5	K-3902	MOUNTING BRACKET	4306412	1		
6	X-8C-609	SCREW		5	3/8 - 16 X 1-3/4	K-3902

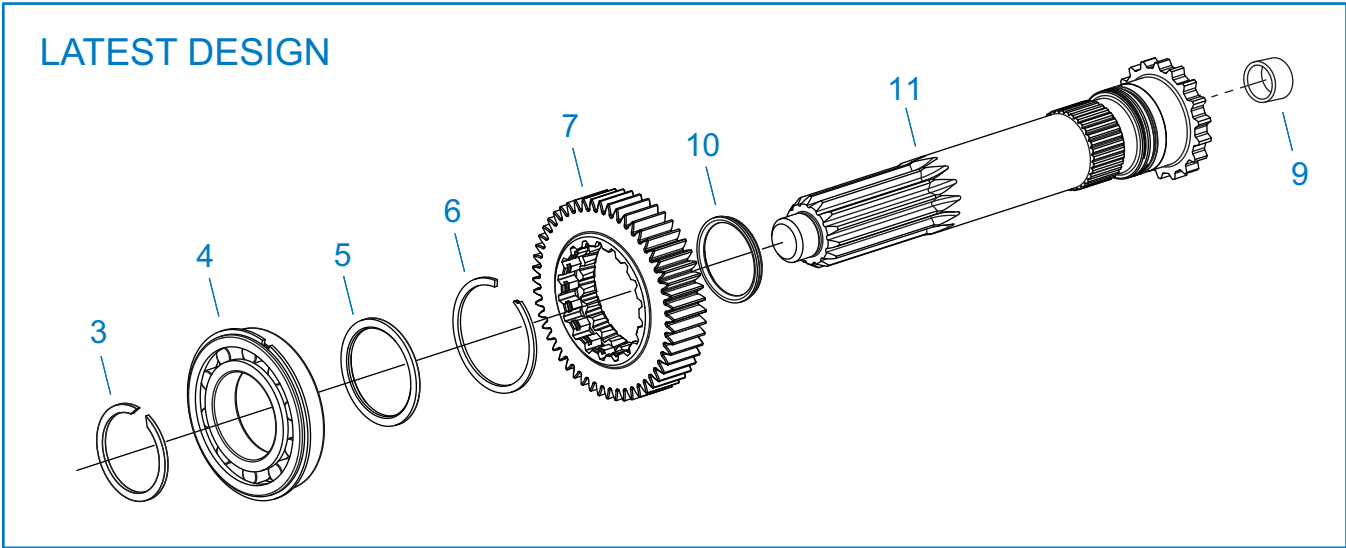
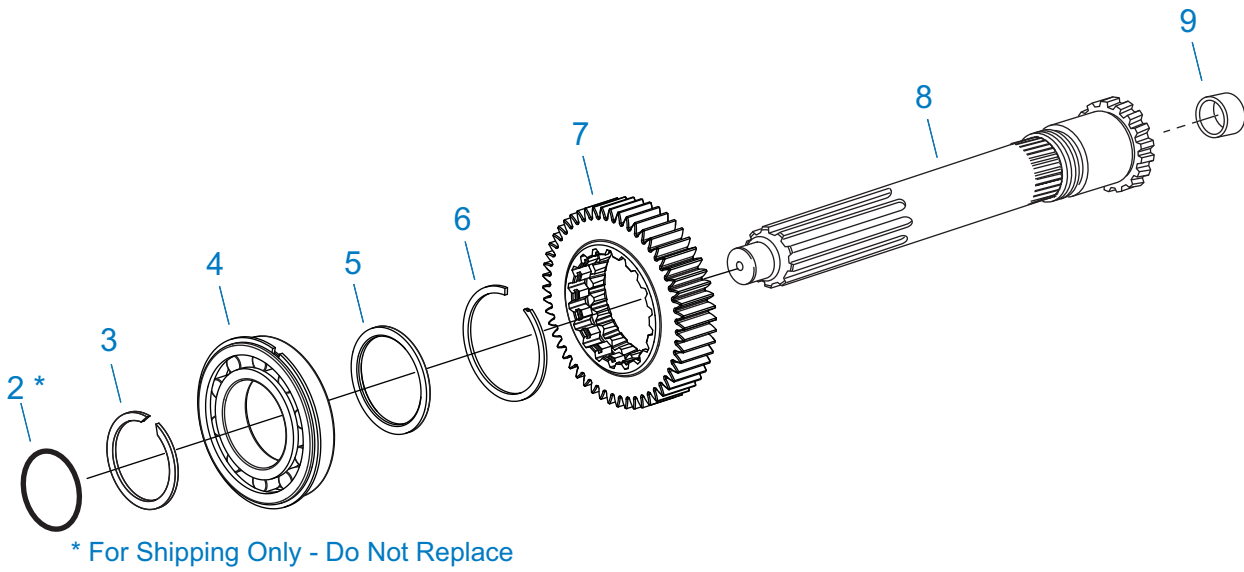

10370C-01-11

INPUT SHAFT & DRIVE GEAR

Item	Current Part	Description	Replaced Part	Qty.	Notes	Kits/Assys Where Needed
2	5568554	O-RING		1	NOT SOLD FOR SERVICE	
3	16980	SNAP RING		1		K-3941,K-4140,K-4143,K-4145
4	4301417	BEARING		1		K-3941,K-4145
5	16463	SPACER		1		
6	14750	SNAP RING		1		K-3941,K-4140,K-4145
7	4304510	MAIN DRIVE GEAR		1		

Item	Current Part	Description	Replaced Part	Qty.	Notes	Kits/Assys Where Needed
8	K-4144	INPUT SHAFT REPLACEMENT KIT	4306467,S-3078	1		
9	16566	BUSHING		1		K-3941
10	K-4142	SEAL KIT	23559	1		K-4143,K-4145
11	K-4143	INPUT SHAFT KIT	4308011,S-3127	1	MUST BE USED WITH 4308012 FRONT BEARING COVER	K-4144

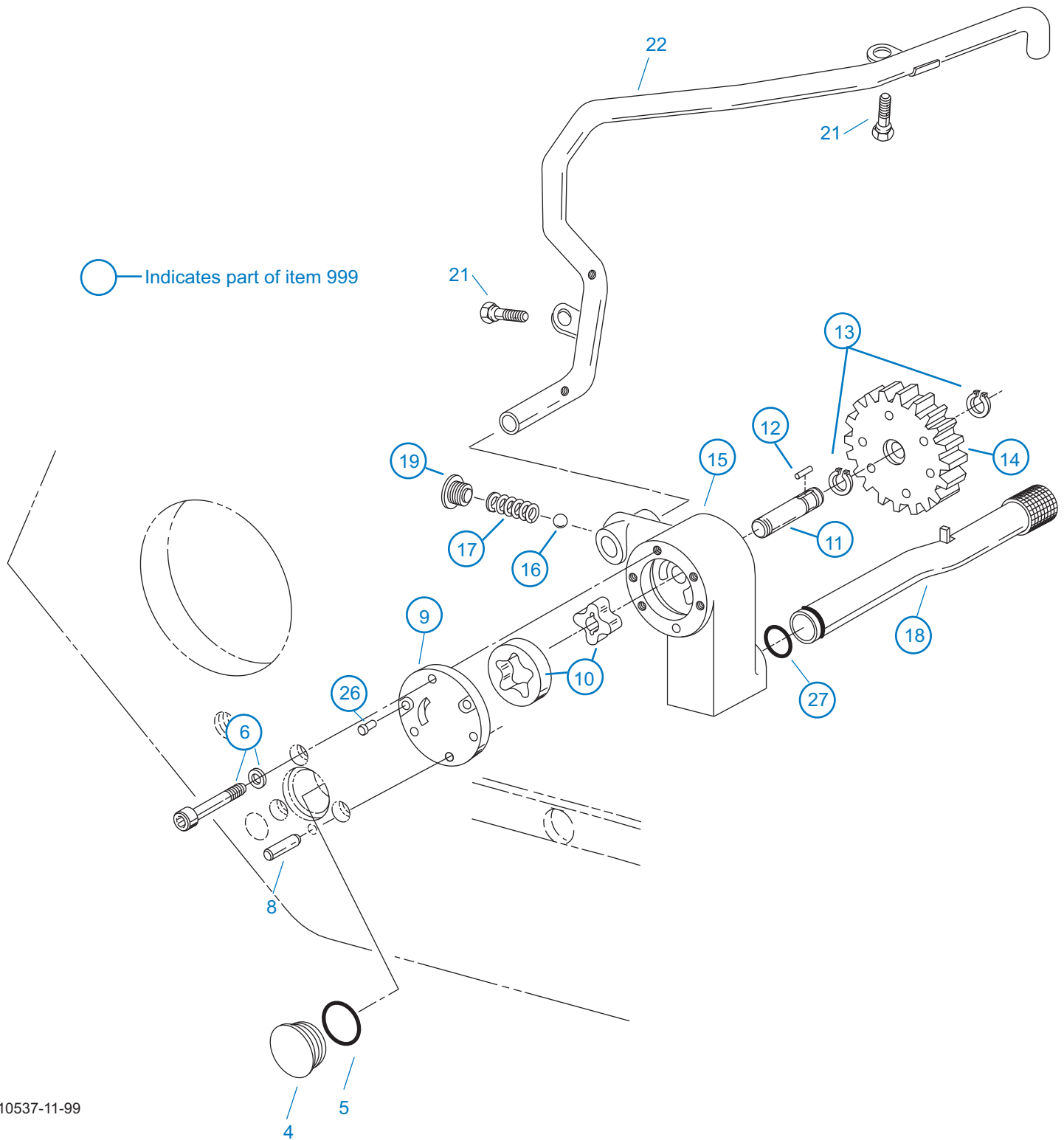

10537-11-99

INTEGRAL OIL PUMP

Item	Current Part	Description	Replaced Part	Qty.	Notes	Kits/Assys Where Needed
4	20823	PLUG		1		

Item	Current Part	Description	Replaced Part	Qty.	Notes	Kits/Assys Where Needed
5	14765	-O- RING		1		
6	K-4126	FASTENER KIT	20824, X-8-448	1	KIT CONTAINS 3 FASTENERS AND 3 WASHERS	K-3367
8	20825	DOWEL PIN		1		
9	4303773	RETAINER		1		
10	K-3367	OIL PUMP KIT	4301829 ,4301948 ,4303776 ,4304529 ,4304572 A - 6963 ,A - 7173	1		
11	K-3367	OIL PUMP KIT	4301829 ,4301948 ,4303776 ,4304529 ,4304572 A - 6963 ,A - 7173	1		
12	20509	KEY		1		
13	14853	SNAP RING		2		
14	4303774	PUMP DRIVE GEAR	4304880	1		
15	K-3367	OIL PUMP KIT	4301829 ,4301948 ,4303776 ,4304529 ,4304572 A - 6963 ,A - 7173	1		
16	X-14-700	STEEL BALL		1	7/16"	
17	4303775	SPRING		1		
18	4305713	SUCTION TUBE	4304628	1	O-RING INCLUDED ON SUCTION TUBE	K-3367
19	4304629	PLUG		1		
21	X-8-686	CAPSCREW		2	3/8"-16X3/4"	
22	4305715	SPLITTER LUBE TUBE	A - 7197	1		
26	X-8-447	SCREW		2		
27	20225	-O- RING		1		
999	K-3367	OIL PUMP KIT	4301829 ,4301948 ,4303776 ,4304529 ,4304572 A - 6963 ,A - 7173	1		

KITS & ASSEMBLIES

Item	Current Part	Description	Replaced Part	Qty.	Notes	Kits/Assys Where Needed
	K-1698	-O- RING/ELEMENT KIT		1		
	K-2170	FILTER REG KIT		1		
	K-2805	SHIM KIT		1		K-3941
	K-2908	-O- RING KIT		1		
	K-2918	OIL SEAL KIT		1		K-3941
	K-2947	COUNTERSHAFT REPL KIT		1		
	K-3365	RANGE CYL COVER KIT		1		
	K-3366	SPLT CYL COVER KIT		1		
	K-3367	OIL PUMP KIT		1		
	K-3438	POSITION SENSOR KIT		1		
	K-3441	OIL FILTER/ADAPTER KIT		1		
	K-3492	SYNCHRONIZER KIT		1		
	K-3523	SPEEDO PLUG KIT		1		
	K-3682	RANGE/SPLITTER VALVE KIT		1		
	K-3734	TRANS CONTROLLER MOUNTING KIT		1		
	K-3784RX	REMAN EXCH GEN 3 X-Y SHIFTER KIT		1		
	K-3902	HEAT EXCHANGER MOUNTING BRACKET KIT		1		
	K-3936	ECA INLINE KIT		1		
	K-3938	SPEED SENSOR KIT		1	FOR USE AT INPUT SHAFT, MAINSHAFT AND CLUTCH LOCATIONS	
	K-3939	GASKET KIT		1		K-3941
	K-3941	BASIC REBUILD KIT		1		
	K-3947	DIRECTIONAL SPEED SENSOR KIT		1	USED IN OUTPUT SHAFT LOCATION	
	K-3984	TRANSMISSION HARNESS KIT		1		
	K-4005	SPLITTER CYLINDER REPAIR KIT		1		

Item	Current Part	Description	Replaced Part	Qty.	Notes	Kits/Assys Where Needed
K-4009		XY SHIFTER REPAIR KIT		1		
K-4012		PTO BRACKET KIT	4306528	1		
K-4035		OUTPUT YOKE / FLANGE RETAINER KIT	4306303	1		K-4140
K-4036		CROSS-SHAFT ASSEMBLY KIT		1		K-4145
K-4037		ECA CLUTCH GREASE LINE KIT		1		
K-4058		ECA SPEED SENSOR JUMPER HARNESS KIT		1		
K-4088		HAND HOLE COVER KIT		1		
K-4103		ECA SHIELD KIT	A-8155	1		
K-4134		LCIB BRAKE ASSY KIT	1271043	1		
K-4139		ECU ASSEMBLY KIT (VHP)		1		
K-4140		SMALL PARTS KIT		1		
K-4142		SEAL KIT		1		K-4143,K-4145
K-4143		INPUT SHAFT KIT		1		K-4144
K-4144		INPUT SHAFT REPLACEMENT KIT	S-3078	1		
K-4145		CLUTCH INSTALLATION KIT	K-4059	1		
S-3022		SHIFT BAR HOUSING ASSY		1	HOUSING ONLY	
S-3106		REAR BEARING COVER ASSY		1		
S-3111		SHIFT BAR HOUSING ASSY		1	COMPLETE	
S-3120		MAINSHAFT ASSY	4306316	1		
S-3121		CASE ASSY	4306036	1		

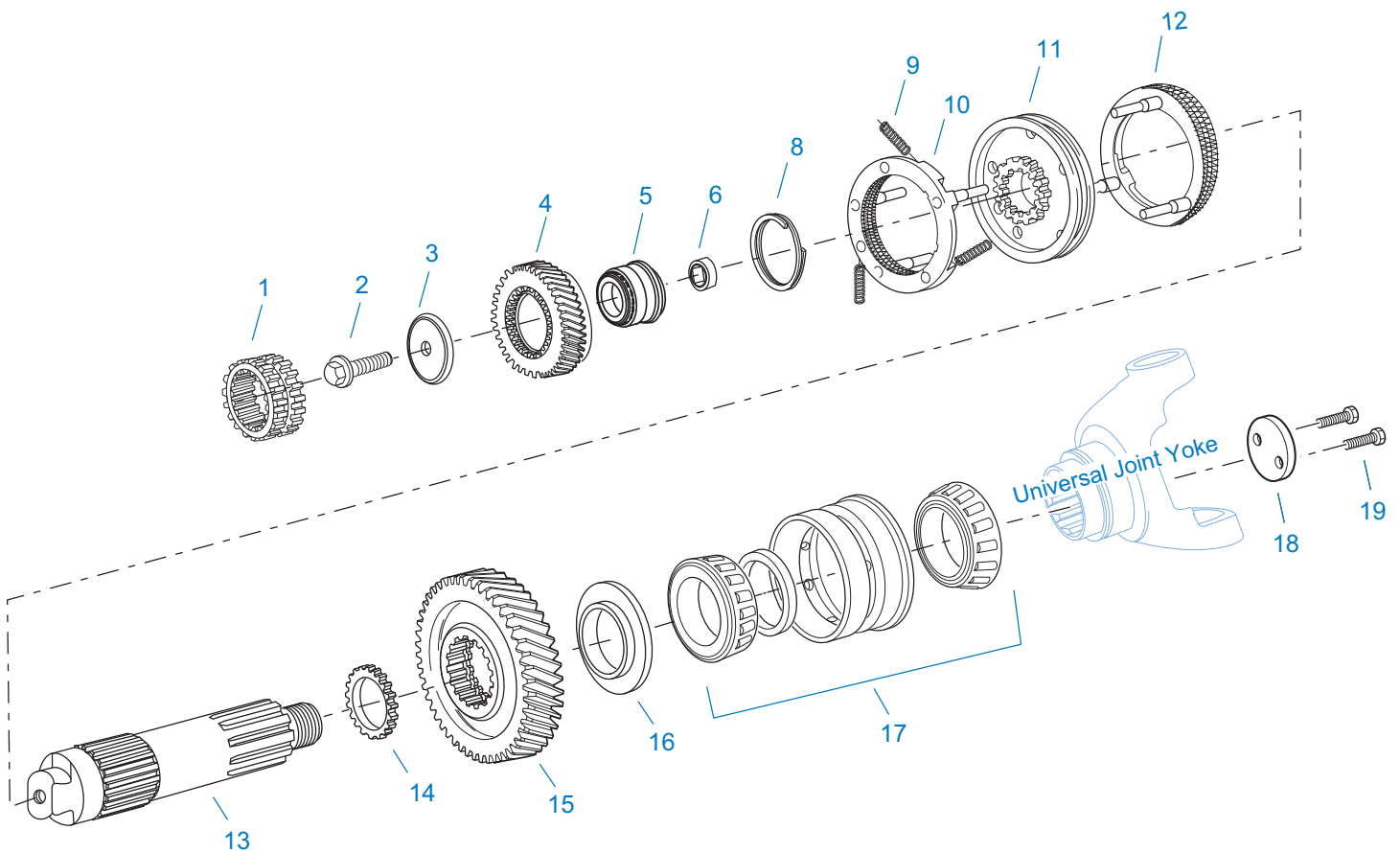

10438B-06-11

MAINSHAFT & SYNCHRO(AUX)

Item	Current Part	Description	Replaced Part	Qty.	Notes	Kits/Assys Where Needed
1	691934	SLIDING CLUTCH-SPLITTER	4303822	1		
2	X-7-1007	SCREW		1	5/8"-18X1-3/4"	
3	4301843	RETAINER		1		
4	691445	SPLITTER GEAR		1		
5	4300902-BOX	TAPERED ROLLER BRG	4300902	1		K-3941
6	4301844	BEARING SLEEVE		1		K-3941
8	4303424	SNAP RING		1		
9	14897	SPRING		3		K-3492,K-3941,K-4140
10	A-7331	SYNCHRONIZER ASSY	4304396 ,4304397 ,A - 5917	1	HI RANGE	K-3492
11	4301840	SLIDING CLUTCH	4303386	1		

Item	Current Part	Description	Replaced Part	Qty.	Notes	Kits/Assys Where Needed
12	A-7254	SYNCHRONIZER ASSEMBLY	A - 4937 ,A - 5876	1	LO RANGE	K-3492
13	4306305	MAINSHAFT		1		
14	4301842	WASHER		1		
15	4301795	REDUCTION GEAR	4301794	1		
16	4300912	SPACER		1		
17	5556507	TAPERED ROLLER BEARING		1		K-3941
18	K-4035	OUTPUT YOKE / FLANGE RETAINER KIT		1		K-4140
19	X-8-1209M	HEX FLANGE HEAD SCREW		2	M12X1.25X60	K-4035

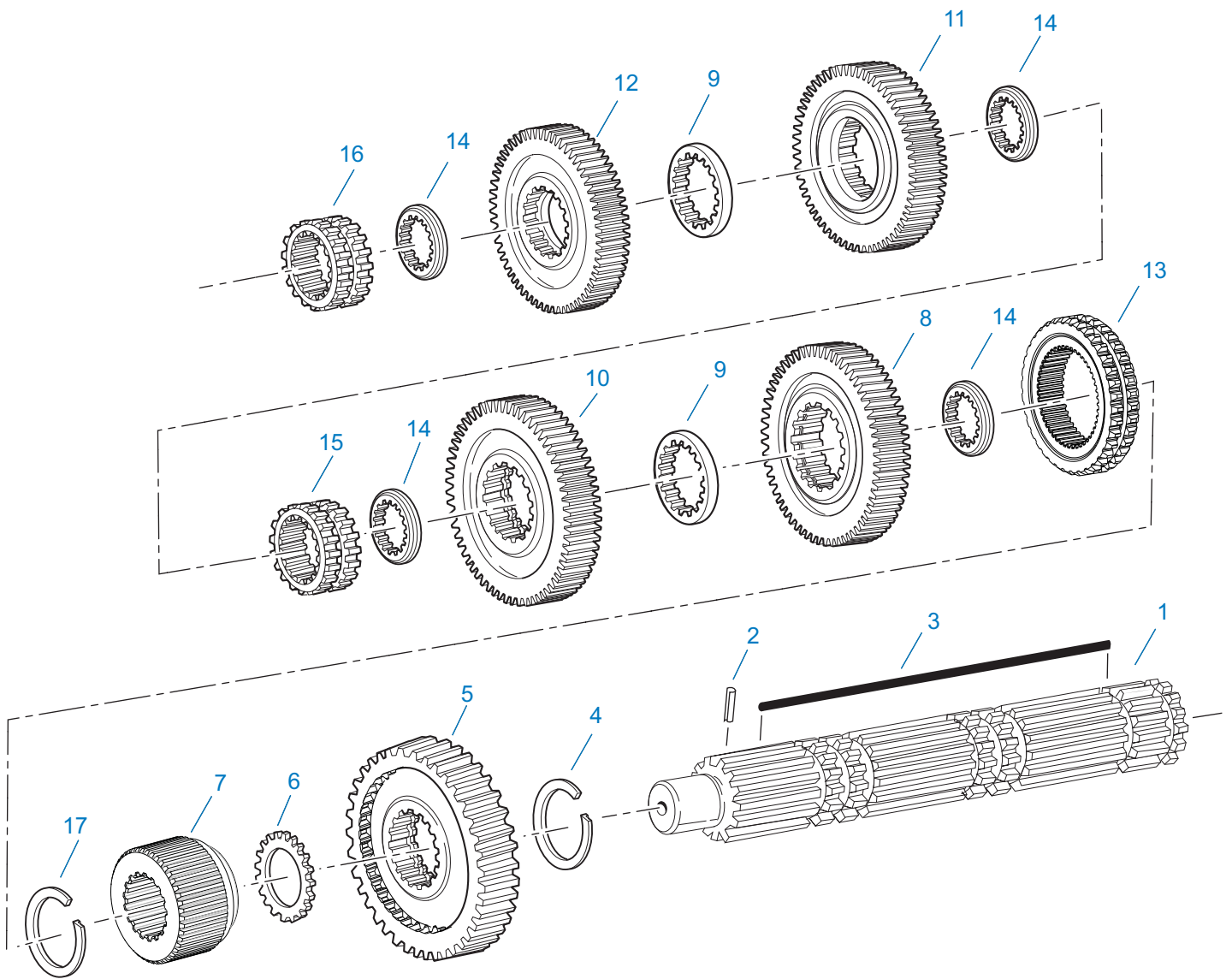

11322-11-10

MAINSHAFT ASSY

Item	Current Part	Description	Replaced Part	Qty.	Notes	Kits/Assys Where Needed
1	S-3120	MAINSHAFT ASSY	4306316	1		
2	62504	ROLL PIN		1		S-3120
3	4306293	KEY, MAINSHAFT (SPECIAL)		1		
4	4306308	SNAP RING		1		K-3941,K-4140
5	4306282	REVERSE GEAR-MAINSHAFT		1		
6	4306292	SPACER		1		K-4140

Item	Current Part	Description	Replaced Part	Qty.	Notes	Kits/Assys Where Needed
7	4306541	MAINSHAFT SLEEVE		1		
8	4306284	LO GEAR-MAINSHAFT		1		
9	4303603	WASHER		2		K-4140
10	4303701	1ST GEAR-MAINSHAFT		1		
11	4302670	2ND GEAR-MAINSHAFT		1		
12	4304514	OD GEAR-MAINSHAFT		1		
13	4306540	SLIDING CLUTCH		1	LO / REVERSE	
14	4302398	WASHER		4		K-4140
15	4305997	SLIDING CLUTCH		1	1ST / 2ND	
16	4305996	SLIDING CLUTCH		1	OD / DIRECT	
17	4301254	SNAP RING		1		K-3941,K-4140

11 Oil Filter Cover Kit
(not pictured)

○ - Contained in Item #11

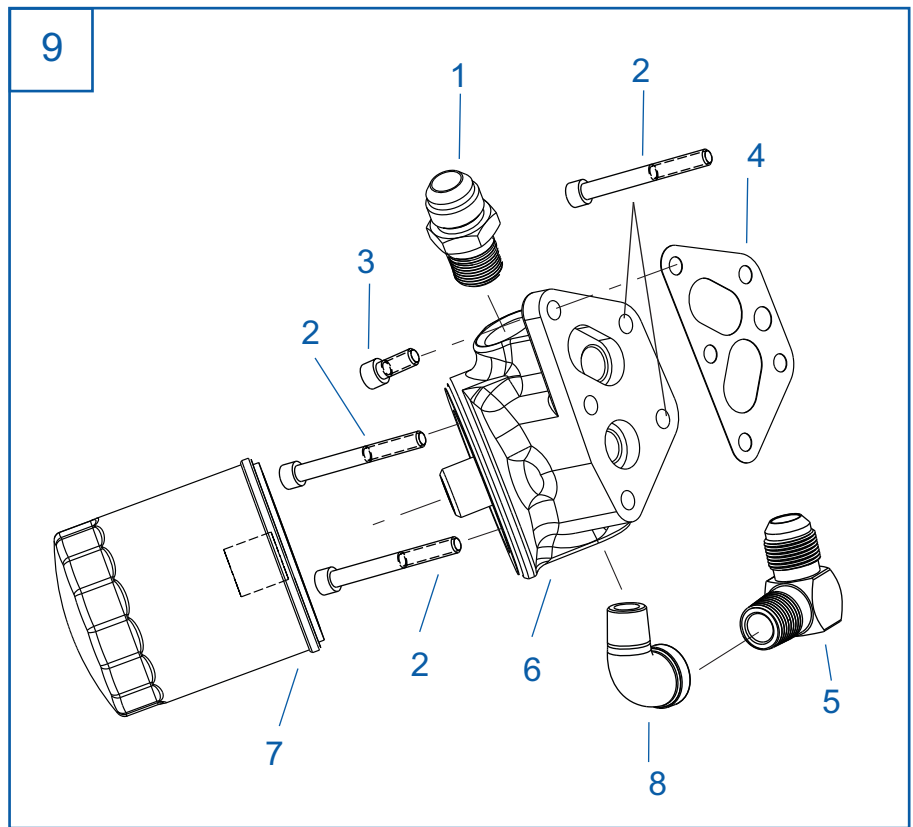
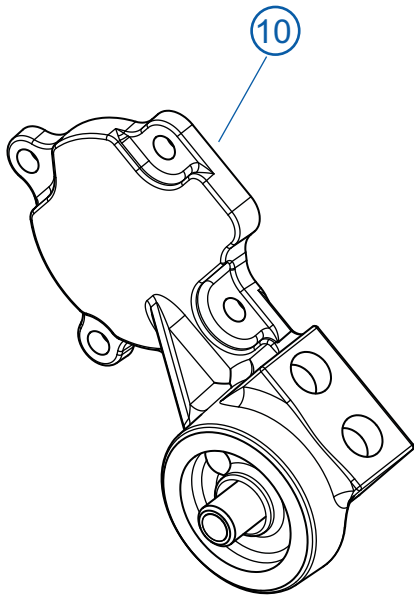

10539-3-00

OIL FILTER

Item	Current Part	Description	Replaced Part	Qty.	Notes	Kits/Assys Where Needed
1	19419	CONNECTOR		1		K-3441,K-3547
2	X-8-453	SCREW		4		K-3441
3	X-8-452	SCREW		1		K-3441
4	4304820	GASKET		1		K-3441,K-3939
5	4301123	ELBOW		1		K-3441
6	K-3441	OIL FILTER/ADAPTER KIT	A - 7174	1		
7	4304827	OIL FILTER ELEMENT		1		K-3441,K-3547
8	17007	ELBOW		1		K-3441
9	K-3441	OIL FILTER/ADAPTER KIT		1		
10	A-7300	AUX COUNTERSHAFT COVER ASSY		1		K-3547
11	K-3547	OIL FILTER COVER KIT		1	CONTAINS A-7300	

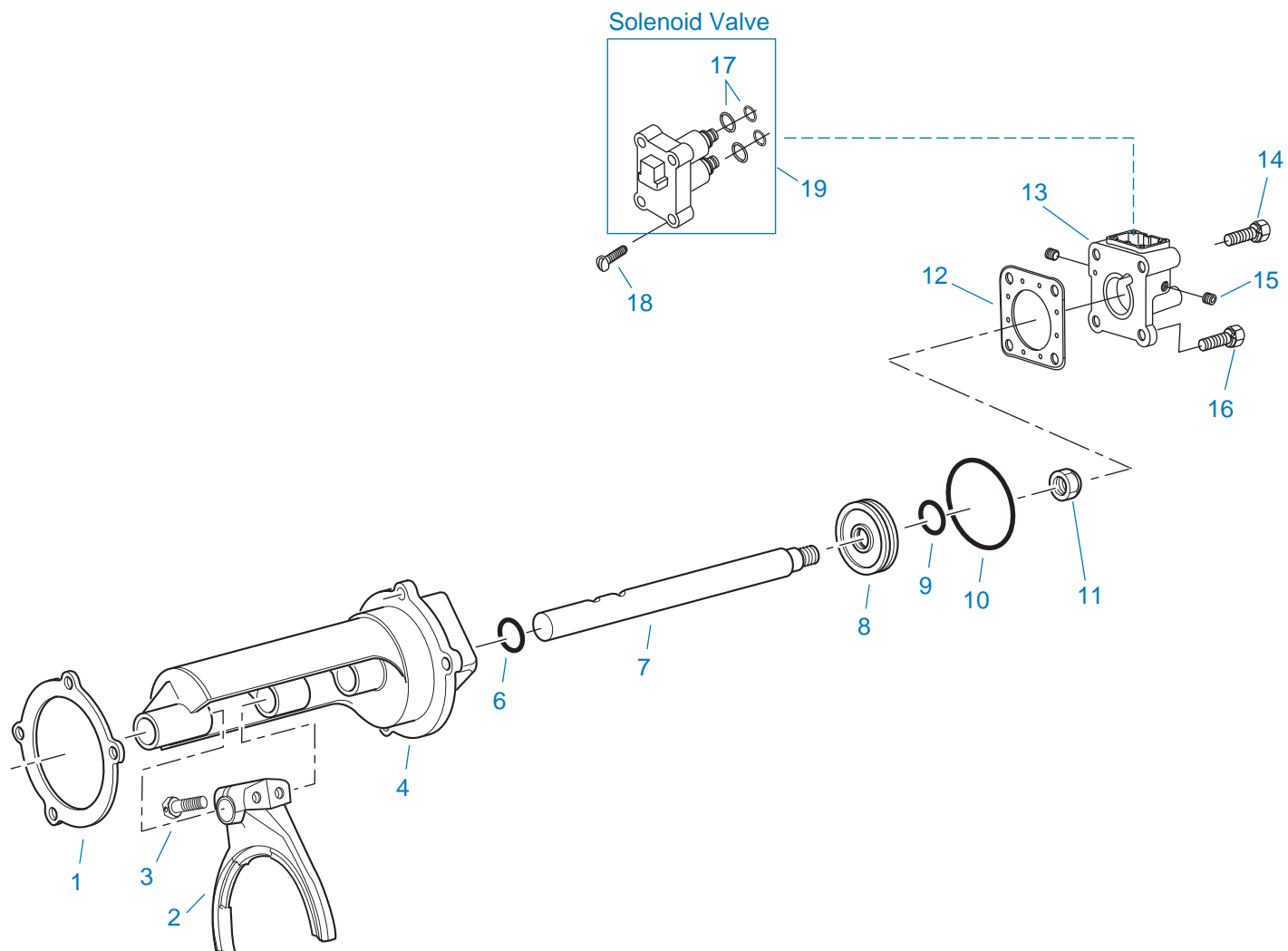

12461-08-01

RANGE CYLINDER

Item	Current Part	Description	Replaced Part	Qty.	Notes	Kits/Assys Where Needed
1	14347	GASKET		1		K-3939
2	22823	SHIFT YOKE	16775	1		
3	X-7-809	BOLT	X 7 810 ,X 7 811	2	1/2"-20X1-3/4"	
4	A-6690	RANGE CYLINDER ASSY	4303595	1		
6	14765	-O- RING		1		
7	4303596	YOKE BAR		1		
8	14341	PISTON	23353	1		
9	14345	-O- RING		1		
10	14344	-O- RING		1		

Item	Current Part	Description	Replaced Part	Qty.	Notes	Kits/Assys Where Needed
11	X-1-1010	NUT		1	5/8"-18	
12	691955	GASKET	691440	1		K-3365,K-3939
13	K-3365	RANGE CYL COVER KIT	691442	1		
14	X-8L-636	CAPSCREW		2	3/8"-16X3-3/4"	
15	X-12-208	PIPE PLUG		3	1/8" NPT	
16	X-8L-607	CAPSCREW		2	3/8"-16X2-1/4"	
17	K-2908	-O- RING KIT		1	FOR SOLENOID VALVE	
18	X-8-264	HEX FLANGE HEAD SCREW	X 8 259	4	#10-24 X 1 1/4	
19	K-3682	RANGE/SPLITTER VALVE KIT	5561801 ,5561804 ,K - 2907	1		

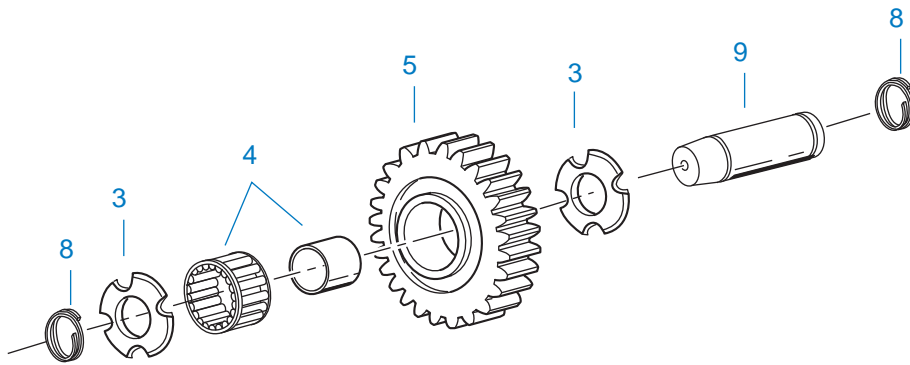

11382A-10-04

REVERSE IDLER

Item	Current Part	Description	Replaced Part	Qty.	Notes	Kits/Assys Where Needed
3	4302982	WASHER	14282	4		
4	14287	BEARING	4305020	2		K-3941
5	16757	REVERSE IDLER GEAR	22409	2		
8	4303336	RETAINING RING		4		
9	4305513	IDLER SHAFT		2		

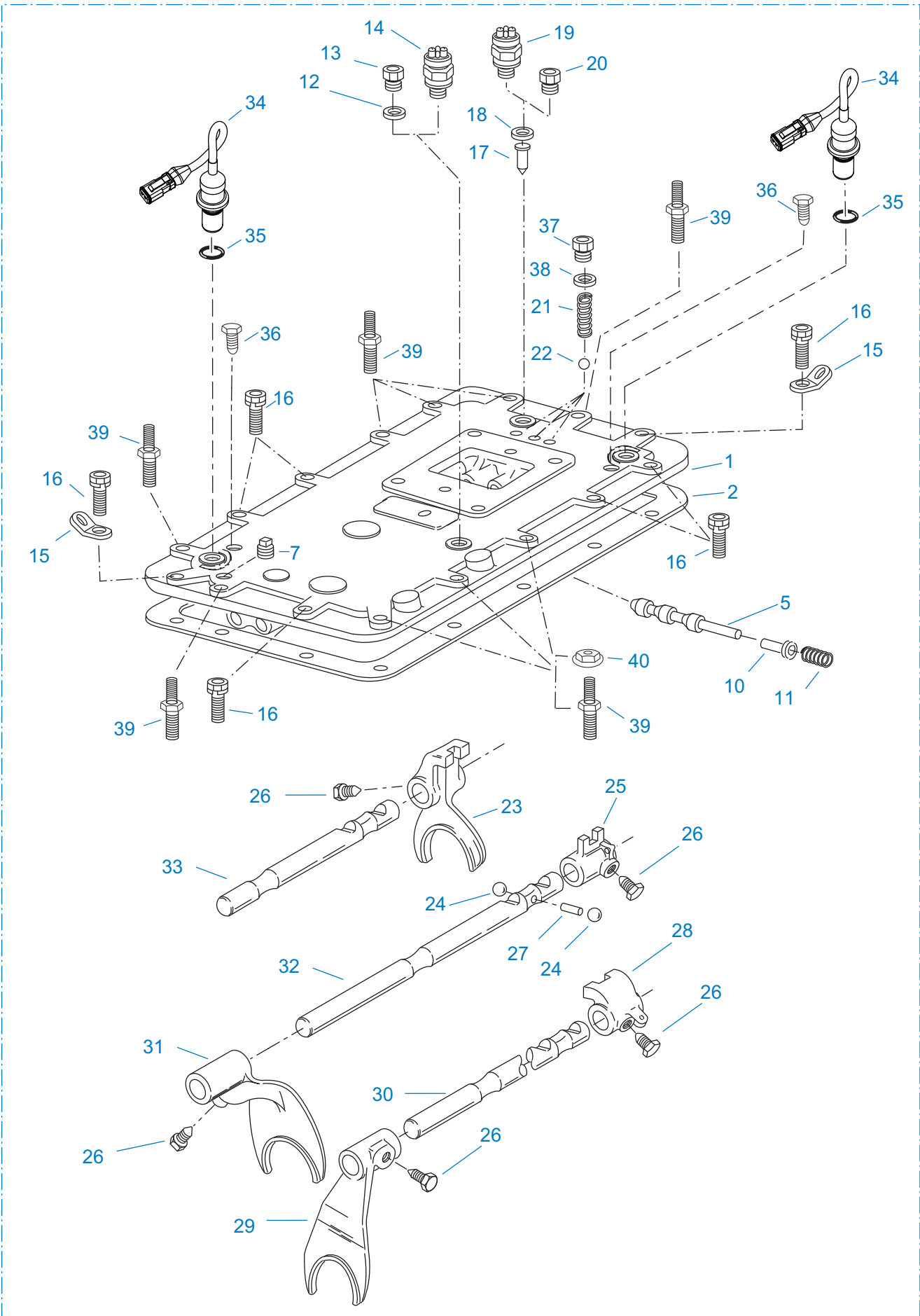

SHIFT BAR HOUSING

Item	Current Part	Description	Replaced Part	Qty.	Notes	Kits/Assys Where Needed
1	S-3022	SHIFT BAR HOUSING ASSY	4305895	1	HOUSING ONLY	
2	4302676	GASKET	14918	1		K-3939,S-3022,S-3111
5	20332	AIR VALVE SHAFT	17177	1		S-3111
7	X-12-603	PIPE PLUG	X12 602	1	3/8" NPT	S-3111
10	21966	PLUNGER		1		
11	4301372	SPRING		1		
12	17179	GASKET		1		K-3939,S-3022,S-3111
13	4303655	PLUG	17178	1		S-3022,S-3111
14	22941	NEUTRAL LIGHT SWITCH	12639	1	SWITCH NORMALLY CLOSED	
15	20815	LIFTING EYE	17105	2		
16	X-8L-602	CAPSCREW		5	3/8"-16X1-1/2"- TWO FOR LIFTING EYES, 2 FOR HARNESS BRACKET AND 1 FOR STRAIN RELIEF VALVE	
16	X-8L-604	CAPSCREW		2	3/8"-16X1-1/4"	K-3547
17	15899	PIN		1		
18	15900	GASKET		1		K-3939,S-3022,S-3111
19	22940	REVERSE LIGHT SWITCH	16830	1	SWITCH NORMALLY OPEN	
20	4303656	PLUG	15917	1		S-3022,S-3111
21	691661	COMPRESSION SPRING		3		K-4140,S-3111
22	X-14-800	STEEL BALL		3	1/2"	K-4140,S-3111
23	4306286	SHIFT YOKE		1	REVERSE/1ST	S-3111
24	X-14-1200	STEEL BALL		2	3/4"	S-3111
25	14658	SHIFT BLOCK		1	2ND/3RD	S-3111
26	3220	LOCKSCREW		5		S-3111
27	1634	INTERLOCK PIN		1		K-4140,S-3111
28	14659	SHIFT BLOCK		1	4TH/5TH	S-3111
29	691601	SHIFT YOKE	4302212	1	4TH/5TH	S-3111
30	4301366	YOKE BAR		1	4TH/5TH	S-3111
31	691600	SHIFT YOKE	4302994	1	2ND/3RD	S-3111
32	4301365	YOKE BAR		1	2ND/3RD	S-3111

Item	Current Part	Description	Replaced Part	Qty.	Notes	Kits/Assys Where Needed
33	4301364	YOKE BAR		1	REVERSE/1ST	S-3111
34	K-3938	SPEED SENSOR KIT		2	SINGLE PICK-UP (2 PIN)	
35	14142	-O- RING		2		S-3111
36	X-8C-409	CAPSCREW		2	1/4"-20X5/8"	K-3938,K-3947,S-3111
37	4303656	PLUG	15917	3		S-3022,S-3111
38	15900	GASKET		3		K-3939,S-3022,S-3111
39	4305869	SCREW		9	3/8 & 5/16	
40	4305870	NUT ASSEMBLY		3	5/16-18	K-3734,K-4139
999	S-3111	SHIFT BAR HOUSING ASSY		1	COMPLETE	

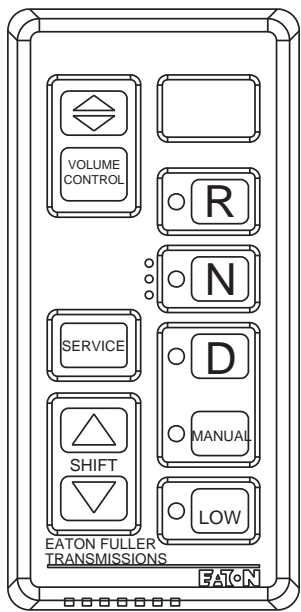

PUSHBUTTON ASSEMBLY

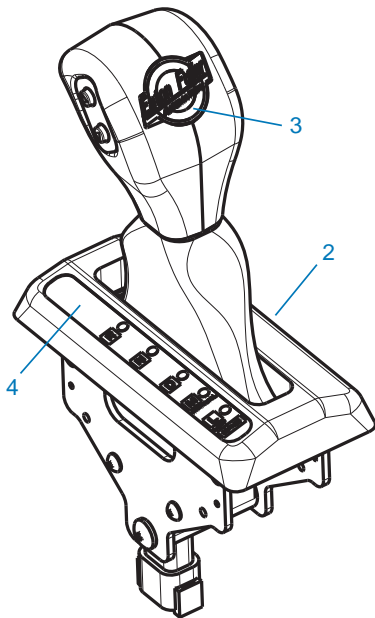

COBRA LEVER - only for use with 10MY559M Mack Swing Arm Bracket

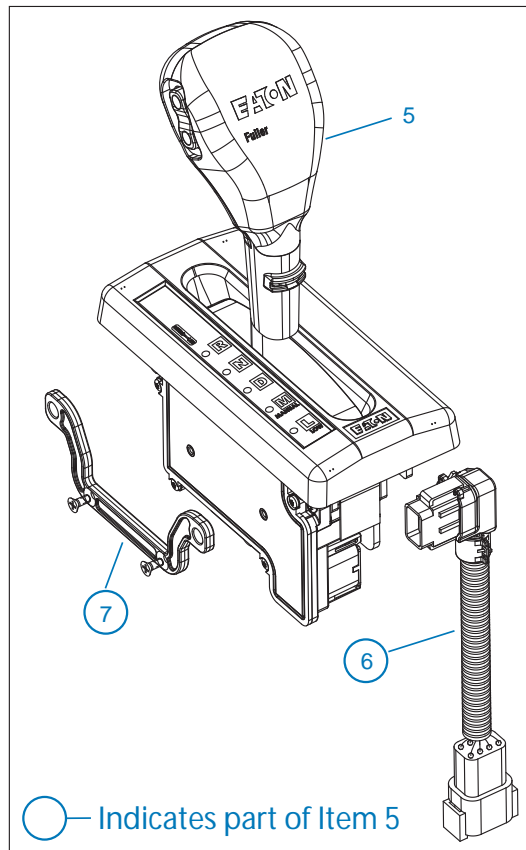

COBRA LEVER - Latest Design - for all applications with the exception of units using the 10MY559M Mack Swing Arm Bracket (see illustration to the left)

10209-06-09

SHIFT CONTROLS

Item	Current Part	Description	Replaced Part	Qty.	Notes	Kits/Assys Where Needed
1	4306043	PUSHBUTTON ASSY	A - 7466,S-3007	1		
2	K-3997	COBRA SHIFT LEVER KIT (RHO) W/MACK SWING ARM	4305447,K-3680	1	(LEFT HAND DRIVE), ALSO KNOWN AS (RHO) RIGHT HAND OPERATION - FOR UNITS USING THE MACK 10MY559M SWING ARM BRACKET	
3	5505111	SHIFT LEVER KNOB DECAL		1		
4	5505110	SHIFT LEVER POSITION STRIP		1		
5	K-3980	COBRA SHIFT LEVER KIT (RHO)	K-3680	1	(LEFT HAND DRIVE), ALSO KNOWN AS (RHO) RIGHT HAND OPERATION	
6	A-7982	JUMPER HARNESS ASSY		1		

Item	Current Part	Description	Replaced Part	Qty.	Notes	Kits/Assys Where Needed
7	K-3979	SPACER KIT		1	INCLUDES (4) SPACER MOUNTING SCREWS	

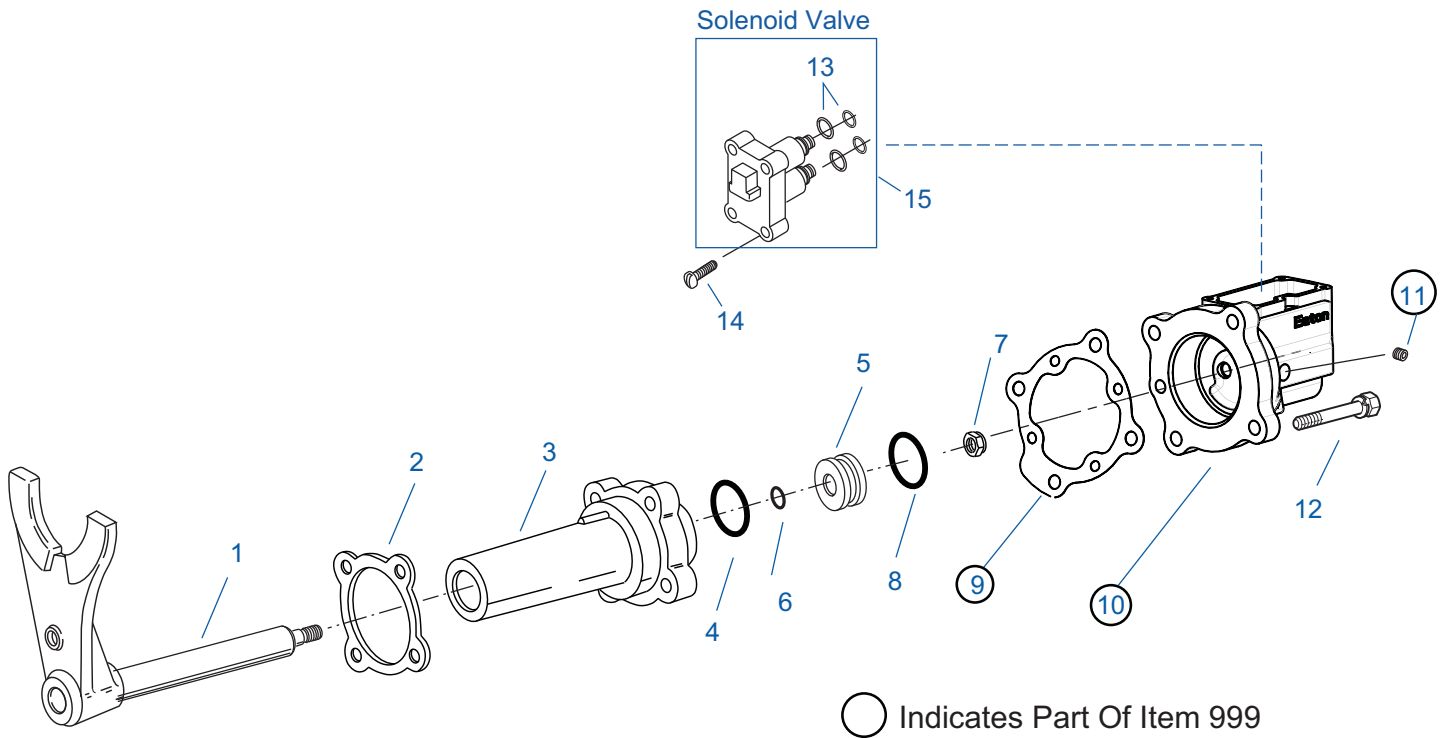

12462-08-01

SPLITTER CYLINDER

Item	Current Part	Description	Replaced Part	Qty.	Notes	Kits/Assys Where Needed
1	A-7012	SPLITTER YOKE ASSY	A - 6304 ,A - 6892	1		
2	4303583	GASKET		1		K-3939,K-4005
3	4306632	SPLITTER CYLINDER		1		K-4005
3	K-4005	SPLITTER CYLINDER REPAIR KIT	4303582	1	COMPLETE REPAIR KIT	
4	21208	-O- RING		1		K-4005
5	4306631	PISTON	4301964	1		K-4005
6	13653	-O- RING		1		K-2908,K-4005
7	X-1-805	NUT		1		K-4005
8	21209	-O- RING		1		K-4005
9	17073	GASKET		1		K-3366,K-3939,K-4005
10	K-3366	SPLT CYL COVER KIT	691444	1		
11	X-12-208	PIPE PLUG		3	1/8" NPT	
12	X-8L-540	CAPSCREW		4	5/16"-18X1-7/8"	
13	K-2908	-O- RING KIT		1	FOR SOLENOID VALVE	

Item	Current Part	Description	Replaced Part	Qty.	Notes	Kits/Assys Where Needed
14	X-8-264	HEX FLANGE HEAD SCREW	X 8 259	4	#10-24 X 1 1/4	
15	K-3682	RANGE/SPLITTER VALVE KIT	5561801 ,5561804 ,K - 2907	1		
999	K-3366	SPLT CYL COVER KIT	691444	1		

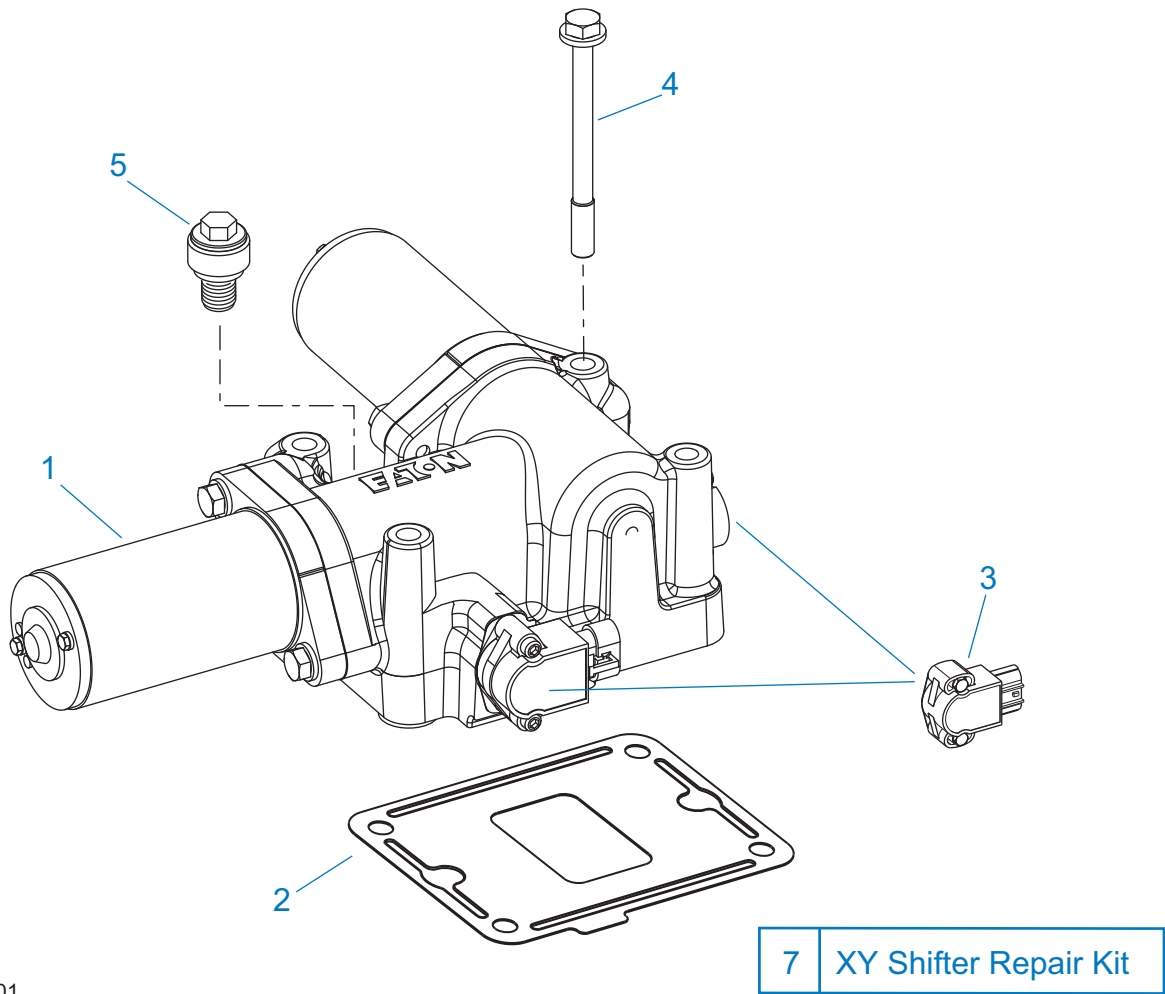

20230-09-01

X-Y SHIFTER MODULE

Item	Current Part	Description	Replaced Part	Qty.	Notes	Kits/Assys Where Needed
1	K-3784RX	REMAN EXCH GEN 3 X-Y SHIFTER KIT	A - 7670,K-3665,K-3784	1		
2	4305452	GASKET	4301958	1		K-3939,K-4009
3	K-3438	POSITION SENSOR KIT	691551 ,691926	2		
4	X-8C-615	CAPSCREW		4		
5	4304602	BREATHER	23605	1	1/4" NPT	
7	K-4009	XY SHIFTER REPAIR KIT		1		

