



Eaton Fuller RTAO-12710C-AC Transmission Parts Manual

This is Eaton Fuller RTAO-12710C-AC Transmission parts manual brought to you by Pro Gear and Transmission to assist you identifying the parts for your Eaton / Fuller transmission unit.

If you need any assistance identifying the correct Eaton / Fuller unit for your truck and equipment, contact your Eaton replacement parts specialists at Pro Gear and Transmission.

Pro Gear stocks every part for your Eaton transmission including: Valve Assemblies, Synchronizers, Yoke Assemblies, O-Ring Kits, Drive Gears, Gaskets, Bearing and Seal Kits, and much more.

Pro Gear and Transmission has same day shipping and thousands of products in stock and ready to ship internationally for your next project.

For parts or service contact the Eaton transmission specialists at Pro Gear & Transmission, Inc.

 CALL US

 EMAIL US

 VISIT MODEL PAGE

 VISIT ONLINE STORE



Roadranger®

More time on the road®

Illustrated Parts List

RTAO-12710C-AC
July 2011

Contents

How To Use The Illustrated Parts List	3
AUXILIARY DRIVE GEAR.....	4
CASE (AUX)	5
CASE (FRONT).....	6
CONTROLLER ECU & HARNESS.....	8
COUNTERSHAFT & BRGS(AUX).....	10
COUNTERSHAFT ASSY	11
DRIVER COMMAND CONSOLE	12
FILTER REGULATOR.....	13
GEAR DISPLAY MODULE.....	14
INPUT SHAFT & DRIVE GEAR	15
INTEGRAL OIL PUMP	16
KITS & ASSEMBLIES	18
MAINSHAFT & SYNCHRO(AUX).....	19
MAINSHAFT ASSY.....	20
MISCELLANEOUS	22
OIL COOLER.....	23
RANGE CYLINDER.....	24
REVERSE IDLER.....	25
SHIFT BAR HOUSING	29
X-Y SHIFTER MODULE.....	30

How To Use The Illustrated Parts List

The information contained in this document is subject to frequent updates. Therefore, for the latest information available, please visit the interactive Electronic Parts Catalog at www.roadranger.com/epc.

Model Designation or Nomenclature

- For information regarding Model Designation and Nomenclature, visit www.roadranger.com.

Kits and Assemblies (K/A's)

- Kits and Assemblies contain groups of individual or assembled parts developed for optimal replacement or repair of a service problem.
- Kits and Assemblies are shown with applicable parts groupings in the parts listings.

Identifying Kits and Assemblies

A- Part numbers beginning with the letter 'A' are pre-assembled Production Assemblies

K- Part numbers beginning with the letter 'K' are kits that are not assembled

S- Part numbers beginning with the letter 'S' are pre-assembled Service Assemblies

- Note: Some Production Assemblies do not begin with a letter prefix (Midrange only).

Illustrations

- Illustrations show parts in assembly groups.
- Item numbers on illustrations correspond with parts listings on pages adjacent to the illustration.
- Notes are included on illustrations where additional information is needed.

Parts Listing

Parts listings are defined by parts groupings and are broken down by service assemblies. Parts listings identify a part for servicing with the following categories

- **Item Number** - corresponding with numbers on illustrations for part identification.
- **Current Part** - identifies part as it is available for service.
- **Description** - specifies part name or description.
- **Replaced Part** - quantity quantity required for assembly.
- **Quantity** - defines unique characteristics or requirements.
- **Notes** - indicates Kits or Assemblies that contain a particular part.
- **Kits/Assy's Where Used**

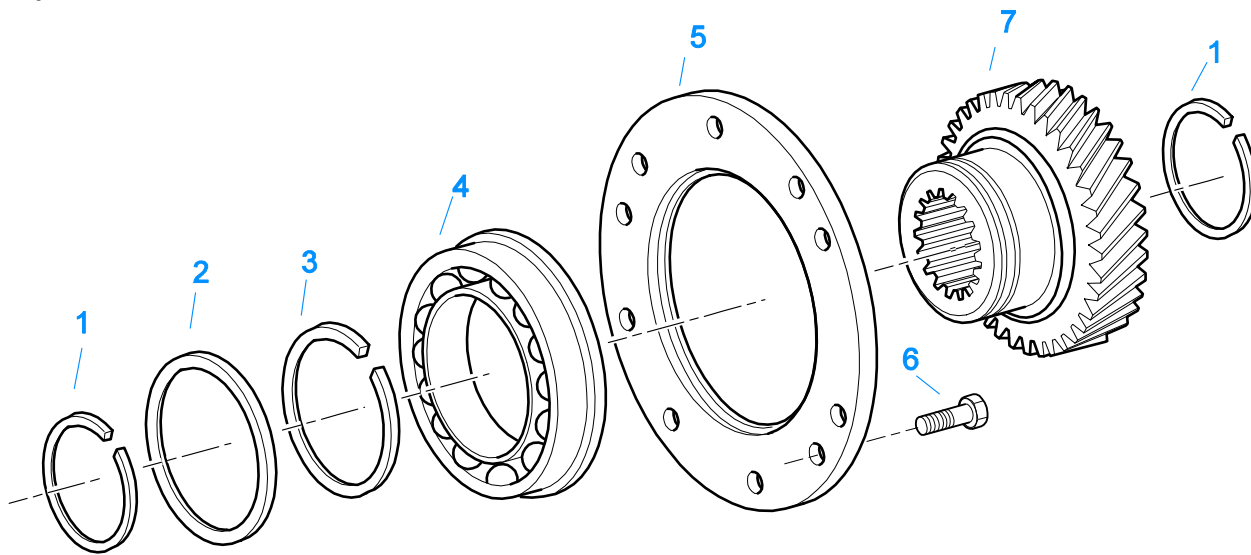

10480-12/92 Aux DG

AUXILIARY DRIVE GEAR

Item	Current Part	Description	Replaced Part	Qty.	Notes	Kits/Assys Where Needed
1	16763	SNAP RING		2		K-2861,K-2862,K-3388
2	21320	SNAP RING RETAINER		1		K-2861,K-2862,K-3388
3	16628	SNAP RING		1		K-3388
4	5566507-BOX	BEARING	5566504,5566507	1		K-2861,K-2862
5	16138	BEARING RETAINER		1		
6	X-8-645	CAPSCREW	X 8 612	6	3/8"-16X1"	
7	23159	AUXILIARY DRIVE GEAR	21321	1		

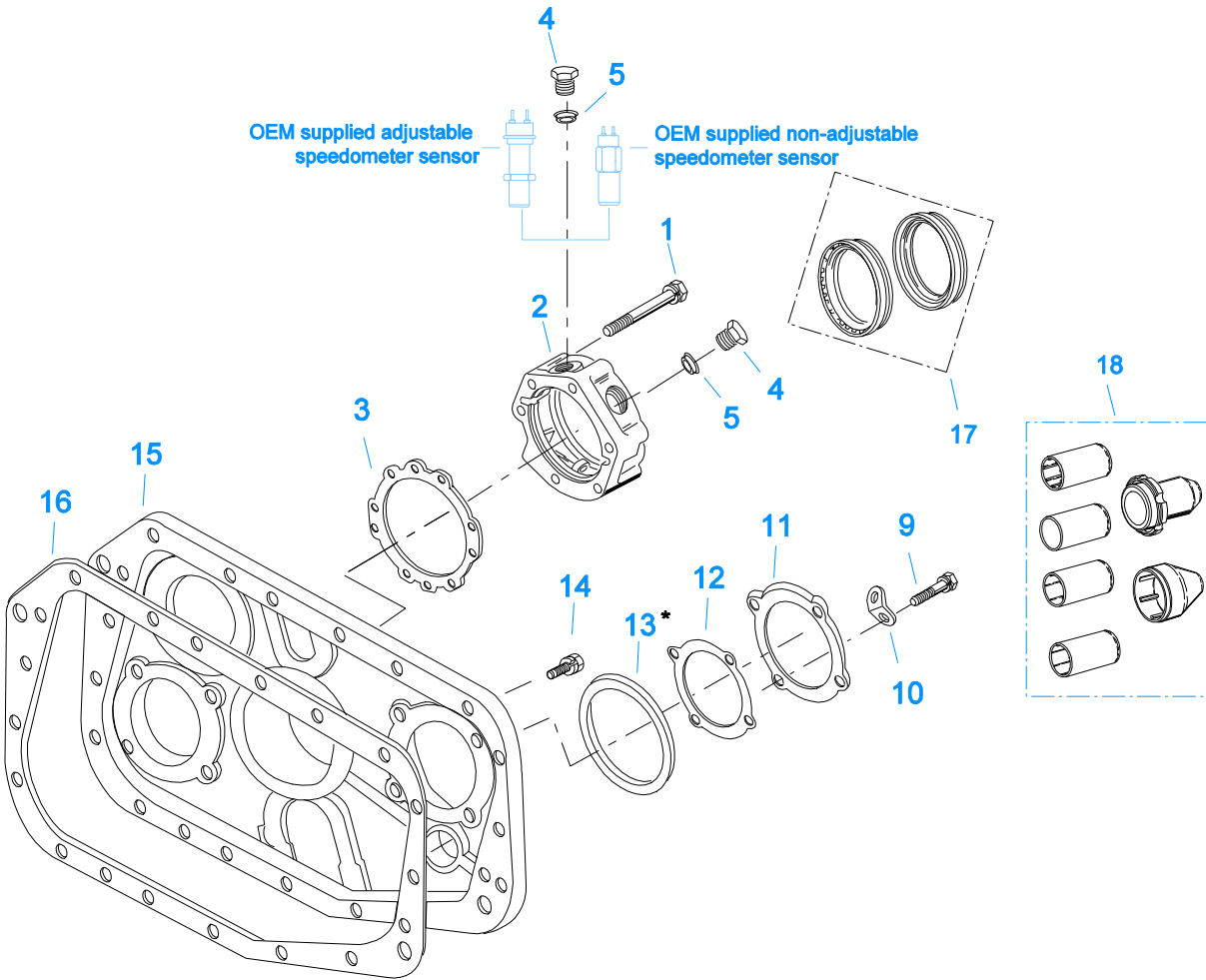

* See Service Manual for Proper Shimming Procedure
10406-12-93 Aux Case

CASE (AUX)

Item	Current Part	Description	Replaced Part	Qty.	Notes	Kits/Assys Where Needed
1	X-8L-631	CAPSCREW	X 8 631	6	3/8"-16X3-1/2"	
2	S-2257	REAR BRG COVER ASSY	4302556	1		
3	21364	GASKET		1		K-2262,K-2860,S-2257
4	20224	PLUG-MAGNETIC		2		S-2257
5	4301954	SENSOR SEAL		2		S-2257
9	X-8L-600	CAPSCREW		8	3/8"-16X1"	
10	20815	LIFTING EYE		2		
11	4302320	COVER	21346	2		
12	4305978	GASKET	4302246	2		K-2860
13	K-2805	SHIM KIT	21452 K - 2106	1		K-2861,K-2862
14	X-8L-602	CAPSCREW		16	3/8"-16X1-1/2"	
14	X-8L-614	CAPSCREW		2	3/8"-16X2"	
14	X-8L-616	CAPSCREW		1	3/8"-16X2-3/4"	
15	22900	REAR HOUSING		1		
16	14335	GASKET		1		K-2860
17	K-2262	OIL SEAL W/SLINGER	19109 20807 20808	1	"FOR MECHANICAL COVER"	K-2861,K-2862
18	K-3651	OIL SEAL TOOL KIT		1		

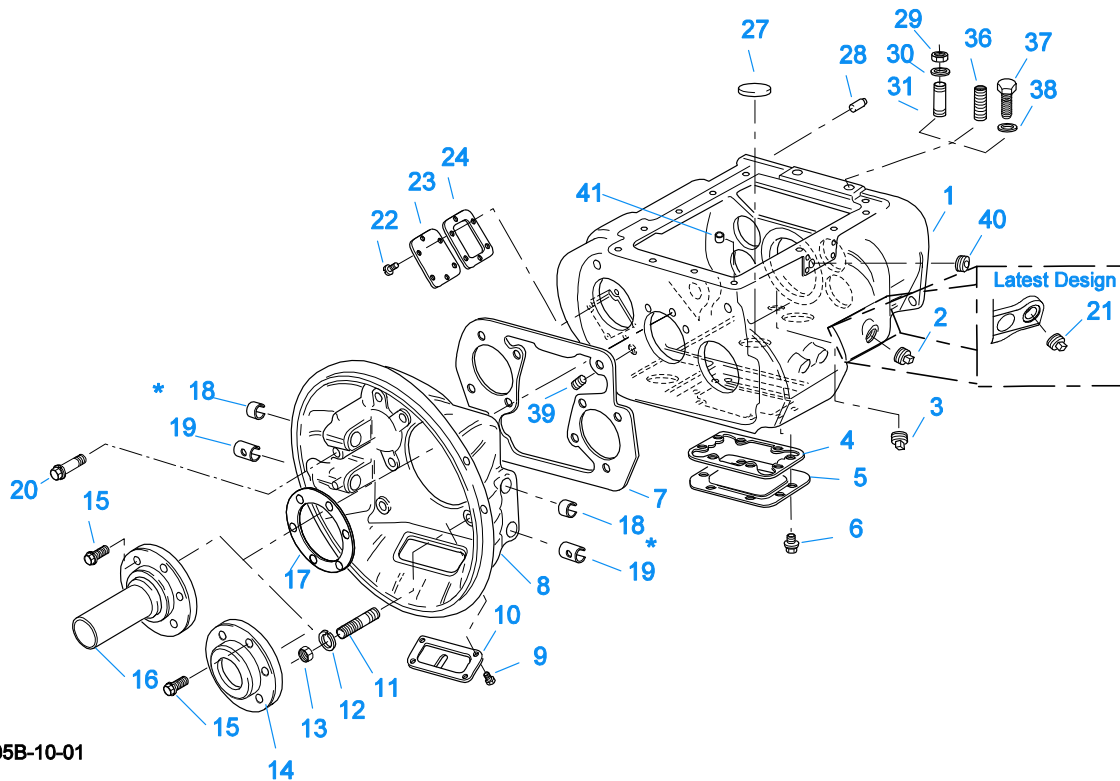

10305B-10-01

* Bushing quantity requirements: #1 Housing – Upper bore use 4 #12815 / Lower bore use 2 #8677.

#2 Housing – Upper bore use 2 #12815 and 1 #8677 / Lower bore use 2 #8677.

Note: Some part requirements are specific to #1 or #2 Aluminum or Iron Clutch Housings and Push or Pull type Clutch.

CASE (FRONT)

Item	Current Part	Description	Replaced Part	Qty.	Notes	Kits/Assys Where Needed
1	S-2996	CASE ASSY	4301355 ,4305766 ,S - 1989	1		
1	S-2998	CASE ASSY	4302218 ,4305765 ,S - 2075	1	FOR USE W/INTEGRAL PUMP	
2	X-12-2007	PIPE PLUG	X12 2006	1		
3	X-12-1207	PIPE PLUG	X12 1202 ,X12 1206	1	3/4" MAGNETIC	
4	4305310	GASKET	4302810	1		K-2860
5	4302809	PTO COVER	16596 ,4300571	1		
6	X-8-725	CAPSCREW		8	7/16"-14X7/8"	
7	4306584	CLUTCH HOUSING GASKET	4304815,4305668	1		K-2860,K-4051
8	A-3713	CLUTCH HOUSING ASSY	A - 3700	1	#1 PUSH-PULL IRON	
8	A-3723	CLUTCH HOUSING ASSY	A - 3721 ,A - 3722	1	#2 PUSH-PULL IRON	
8	A-4772	CLUTCH HOUSING ASSY	A - 4344 ,A - 4771	1	#2 PUSH-PULL ALUM.	
8	A-6064	CLUTCH HOUSING ASSY	A - 4342 ,A - 4770 ,A - 6062 ,A - 6063 ,A - 6065	1	#1 PUSH-PULL ALUM.	
9	239614	SCREW	X-8L-509	4	5/16-18X.81 QUANTITY DEPENDENT ON DESIGN	
10	14506	HAND HOLE COVER		1	#2 PUSH	
10	14507	HAND HOLE COVER		1	#2 PULL	
10	4305230	HAND HOLE COVER	11453	1	#1 PULL	
10	4305231	HAND HOLE COVER	1565	1	#1 PUSH	
11	4306583	STUD	5966	6		
12	X-10-1005	WASHER	X 3 1000 ,X10 1000 ,X10 1004	6	1.23 X 6.60	K-4051
13	X-1-1012	HEX NUT	X-1-1005	6	.625-18	K-4051
14	20550	FRONT BRG COVER		1	2" PULL	K-2468,K-4125
15	X-8L-604	CAPSCREW		6	3/8"-16X1-1/4"	
16	20549	FRONT BRG COVER		1	2" PUSH	
17	14311	GASKET		1		K-2860

Item	Current Part	Description	Replaced Part	Qty.	Notes	Kits/Assys Where Needed
18	12815	BUSHING		2	FOR #2 HOUSING UPPER	A-3713,A-3723,A-4772,A-6064,K-2468
18	12815	BUSHING		4	FOR #1 HOUSING UPPER	A-3713,A-3723,A-4772,A-6064,K-2468
18	8677	BUSHING		1	FOR #2 HOUSING UPPER	A-3713,A-3723,A-4772,A-6064
19	8677	BUSHING		2	FOR #1 AND #2 HOUSING LOWER	A-3713,A-3723,A-4772,A-6064
20	X-8C-830	HEX HEAD SCREW/WASHER ASSY	X-8C-826	4	.500-13 X 1.490, USE 2 PCS FOR IRON HOUSING, USE 4 PCS FOR ALUMINUM HOUSING	K-4051
20	X-8C-831	HEX HEAD SCREW/WASHER ASSY	X-8C-822	2	.500-13 X 3.460, FOR IRON HOUSING	K-4051
21	4304023	PLUG	4303747	1	1-1/16" MAGNETIC, O-RING INCLUDED	S-2996,S-2998
22	X-8-686	CAPSCREW		6	3/8"-16X3/4"	
23	14575	PTO COVER	4302254	1		
24	4305309	GASKET	1684	1		K-2860
27	14373	MAGNET		3		S-2996,S-2998
28	18128	PIN		2		
29	X-1-1012	HEX NUT		2	.625-18	K-4051
30	X-10-1005	WASHER	X 3 1000 ,X10 1000 ,X10 1004	2	1.23 X 6.60	K-4051
31	14554	STUD	1632 ,6579	2	5/8" X 2-3/16"	
36	23104	PLUG	1712	2		
37	X-8-1005	CAPSCREW		2	5/8"-11X1-1/4"	
38	20814	SPACER		2		
39	X-12-802	PIPE PLUG		1	1/2"	
40	X-12-1207	PIPE PLUG	X12 1202 ,X12 1206	1	3/4" MAGNETIC	
41	691447	PIN		1		S-2996,S-2998

Group: CONTROLLER ECU & HARNESS

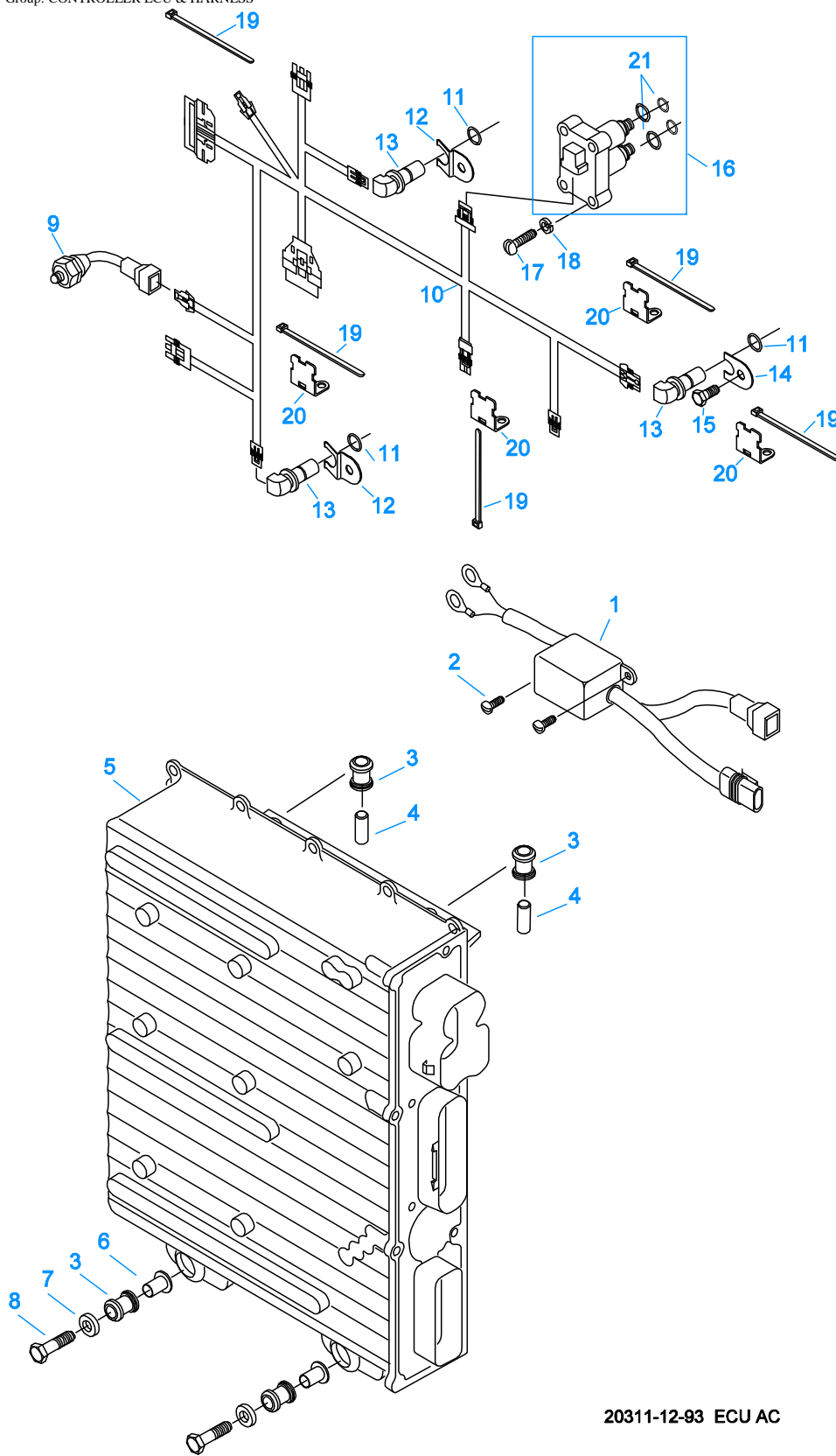

20311-12-93 ECU AC

CONTROLLER ECU & HARNESS

Item	Current Part	Description	Replaced Part	Qty.	Notes	Kits/Assys Where Needed
1	K-3281	P.I.M. REPLACEMENT KIT	4301645	1		

8 Pro Gear and Transmission, Inc | www.progearandtransmission.com | www.pgtruckparts.com
 906 West Gore St, Orlando, FL, 32805 | +1 (877)-776-4600 | +1 (407)-872191 | parts@eprogear.com

Item	Current Part	Description	Replaced Part	Qty.	Notes	Kits/Assys Where Needed
2	X-13-206	SELF-TAPPING SCREW	X13 229	2	5/16"	
3	4301367	MOUNTING PAD		4		
4	4301378	DOWEL PIN		2		S-2612
5	K-2856RX	REMAN EXCHANGE TRANSMISSION CONTROLLER KIT	K-2856, K-2856R	1		
6	4301369	SLEEVE		2		
7	4302114	WASHER		2		
8	X-8-552	SCREW		2	5/16"-18X1-1/2"	
9	K-2604	SHIFT SENSOR KIT	691743 ,4301668 ,4302725	1		
10	K-3352	ECU HARNESS KIT	691301 ,691439	1		
11	2005778	-O- RING		3		
12	4301370	NO LONGER AVAILABLE		2		
13	K-2499	NO LONGER AVAILABLE	4301352	3		
14	4301371	NO LONGER AVAILABLE		1		
15	X-8L-601	CAPSCREW		1	3/8"-16X3/4"	
16	K-3682	RANGE/SPLITTER VALVE KIT	5561801 ,5561804 ,K - 2907	1		
17	X-8-264	HEX FLANGE HEAD SCREW	X 8 259	4	#10-24 X 1 1/4	
18	X-3-301	LOCKWASHER		4	#10 PLAIN	
19	21425	STRAP		5		
20	4301302	BRACKET		4		
21	K-2908	-O- RING KIT		1	FOR SOLENOID VALVE	



10440-1/92 Aux CS Helical

COUNTERSHAFT & BRGS(AUX)

Item	Current Part	Description	Replaced Part	Qty.	Notes	Kits/Assys Where Needed
1	4302074-BOX	BEARING	21343,4302074	4		K-2861,K-2862
2	A-6339	WELDED COUNTERSHAFT ASSY	A - 6073	2	C/S 4302091 - D/G 23160	
3	22903	SPACER		2		K-3388

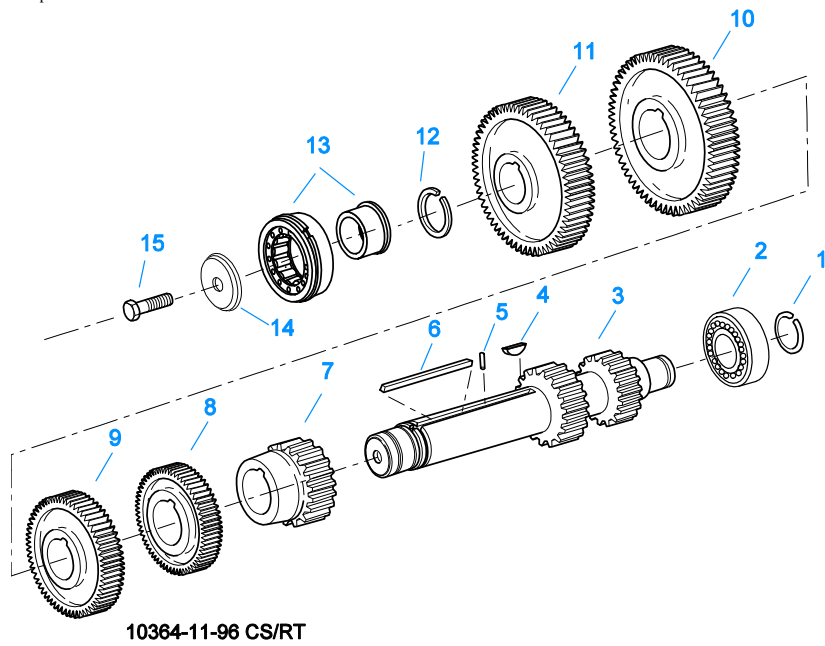

COUNTERSHAFT ASSY

Item	Current Part	Description	Replaced Part	Qty.	Notes	Kits/Assys Where Needed
1	14317	SNAP RING		2		K-2861,K-2862,K-3388
2	14366	BEARING		2		K-2861,K-2862
3	K-2942	CNTRSHFT-W/REV & 1ST	4301224 ,4301225	2		
4	X-6-E	KEY		2		
5	62511	ROLL PIN		2		
6	4304840	KEY	19673	2		
7	20382	2ND GEAR-CNTRSHFT	19269 ,4302103 ,4303512	2		
8	21264	3RD GEAR-CNTRSHFT	19623	2		
9	21262	OD GEAR-CNTRSHFT	19639 ,21027	2		
10	15953	PTO GEAR - LOWER		1		
10	20840	PTO GEAR - UPPER		1		
11	4305665	DRIVE GEAR-CNTRSHFT	21018,4305069	2		
12	19198	SNAP RING		2		
13	4304599	BEARING	4302677 4304598	2		K-2861,K-2862
14	4304605	RETAINER	19548	2	ROLL PIN NO LONGER REQUIRED	
15	X-7-1005	CAPSCREW		2	5/8"-18X1-3/4"	

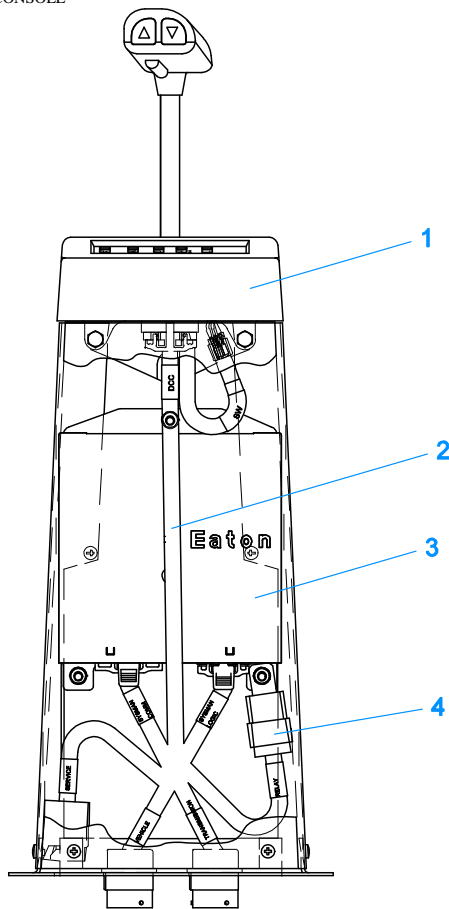

20312-12-93 DCC AC

DRIVER COMMAND CONSOLE

Item	Current Part	Description	Replaced Part	Qty.	Notes	Kits/Assys Where Needed
1	K-3794	NO LONGER AVAILABLE	A-6133	1		
2	K-3318	TOWER HARNESS KIT	691302 ,691539	1		
3	B-100012250	SYSTEM MANAGER ASSY, REMAN	B-1000122501	1		
	1RX	EXCHANGE				
4	X-210-002	POWER CONNECT RELAY		1		

Group: FILTER REGULATOR

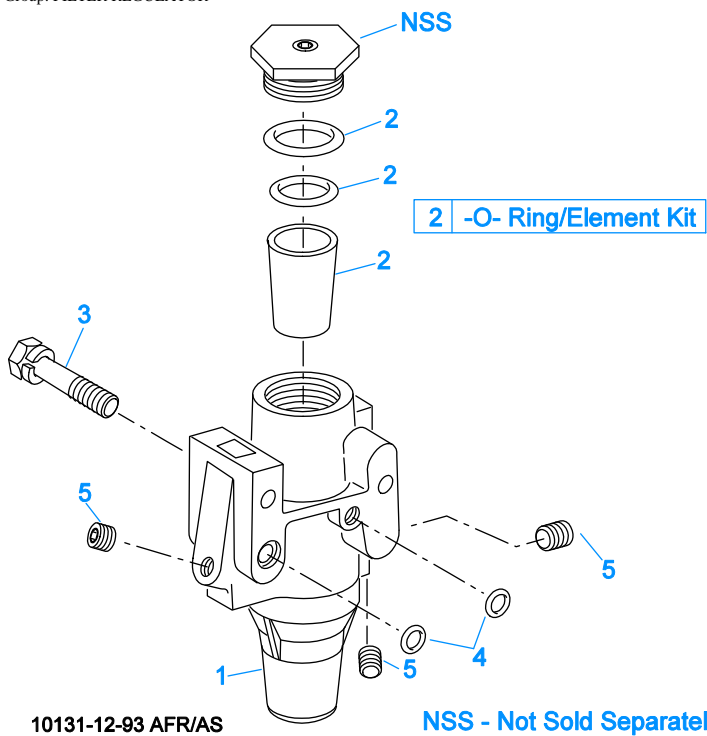

FILTER REGULATOR

Item	Current Part	Description	Replaced Part	Qty.	Notes	Kits/Assys Where Needed
1	K-2170	FILTER REG KIT	A - 5454	1		
2	K-1698	-O- RING/ELEMENT KIT		1	FOR FILTER REGULATOR	
3	X-8C-412	CAPSCREW	X 8S 412	2	1/4"-20X2-1/4"	
4	15114	-O- RING		2		K-2170,K-2909
5	X-12-208	PIPE PLUG		3	1/8" NPT	

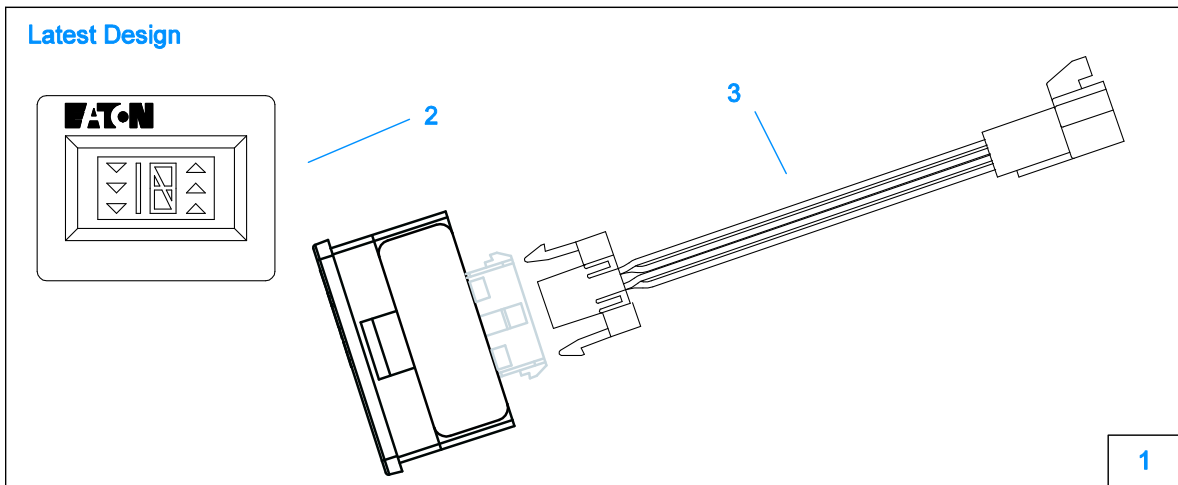
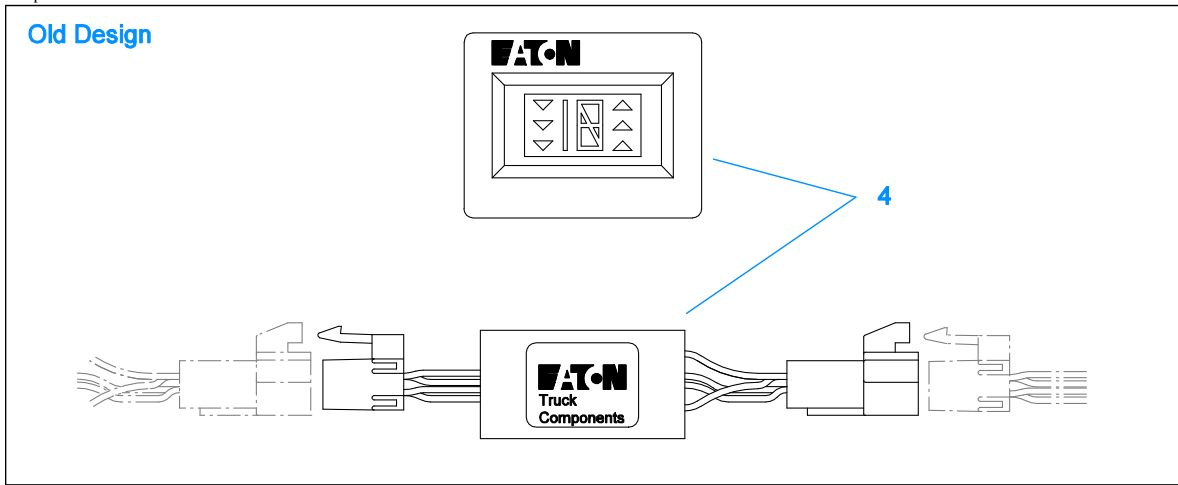

20313-02-01

GEAR DISPLAY MODULE

Item	Current Part	Description	Replaced Part	Qty.	Notes	Kits/Assys Where Needed
1	K-3199	GEAR DISPLAY KIT	4301944 ,A - 6416	1		
1	K-3199	DRIVER DISPLAY MODULE	4302640	1		
3	4303654	ADAPTER HARNESS		1		K-3199
4	K-3199	GEAR DISPLAY KIT	4301944 ,A - 6416	1		

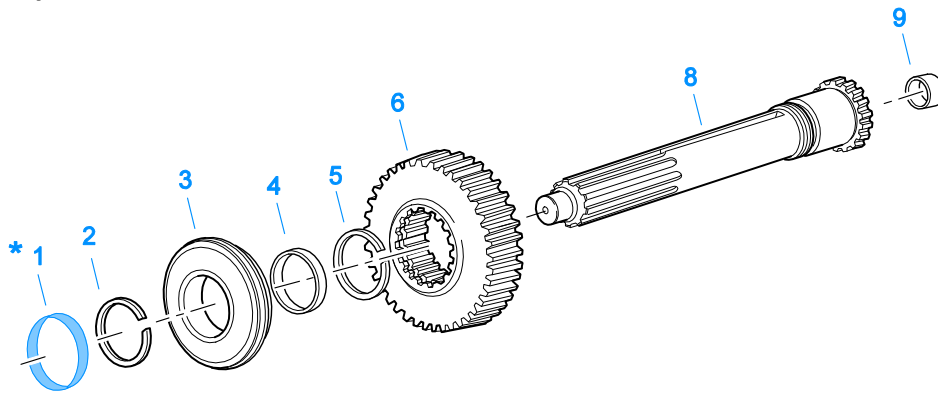

* For Shipping Only -- Do Not Replace

*

10370-1/92 IS

INPUT SHAFT & DRIVE GEAR

Item	Current Part	Description	Replaced Part	Qty.	Notes	Kits/Assys Where Needed
1	23559	SHIPPING SEAL		1	NOT SOLD FOR SERVICE	
2	16980	SNAP RING		1		K-2468,K-2862,K-3388,K-4125
3	81504	BEARING		1		K-2468,K-2861,K-2862,K-4125
4	16463	SPACER		1		
5	14750	SNAP RING		1		K-2468,K-2861,K-2862,K-3388,K-4125
6	22961	MAIN DRIVE GEAR	22959	1		
8	S-1659	INPUT SHAFT	23566	1	2" PULL	K-2468,K-2862,K-4125
8	S-1660	INPUT SHAFT	23567	1	2" PUSH	
9	16566	BUSHING		1		K-2861,S-1659,S-1660



INTEGRAL OIL PUMP

Item	Current Part	Description	Replaced Part	Qty.	Notes	Kits/Assys Where Needed
1	X-8C-409	CAPSCREW		5	1/4"-20X5/8" - USE WITH 4300751 COVER	
1	X-8C-430	CAPSCREW		5	1/4"-20X7/8" - USE WITH 20513 COVER	
2	K-2402	COVER & SCREW KIT	20513 ,4300751	1		K-2402
3	20514	GASKET		1		
4	20823	PLUG		1		
5	14765	-O- RING		1		K-2839
6	X-8-448	SCREW	X 8 445	3	1/4"-20X1-1/4"	
7	20824	WASHER		3		K-3367
8	20825	DOWEL PIN		1		
9	4303107	RETAINER	20510	1		S-2998
10	K-3367	OIL PUMP KIT	4301829 ,4301948 ,4303776 ,4304529 ,4304572 A - 6963 ,A - 7173	1		
11	20518	CRESCENT RING		1		
12	62516	ROLL PIN	62521	1		
13	62514	ROLL PIN		1		
14	K-3367	OIL PUMP KIT	4301829 ,4301948 ,4303776 ,4304529 ,4304572 A - 6963 ,A - 7173	1		
15	X-14-700	STEEL BALL		1	7/16"	
17	20225	-O- RING		1		
18	4305713	SUCTION TUBE	4304628	1	O-RING INCLUDED ON SUCTION TUBE	K-3367
19	20508	DRIVE SHAFT		1		
20	20509	KEY		2		
21	14853	SNAP RING		2		
22	20511	DRIVE GEAR		1		
23	4306584	CLUTCH HOUSING GASKET	4304815,4305668	1		K-2860,K-4051
24	S-2998	CASE ASSY	4302218 ,4305765 ,S - 2075	1	FOR USE W/INTEGRAL PUMP	
25	14373	MAGNET		3		S-2996,S-2998
26	20507	ELEMENT		1		
27	K-3367	OIL PUMP KIT	4301829 ,4301948 ,4303776 ,4304529	1		

Item	Current Part	Description	Replaced Part	Qty.	Notes	Kits/Assys Where Needed
999	K-3367	OIL PUMP KIT	,4304572 A - 6963 ,A - 7173 4301829 ,4301948 ,4303776 ,4304529 ,4304572 A - 6963 ,A - 7173	1		

KITS & ASSEMBLIES

Item	Current Part	Description	Replaced Part	Qty.	Notes	Kits/Assys Where Needed
K-1698		-O- RING/ELEMENT KIT		1	FOR FILTER REGULATOR	
K-1956		COOLER INSTLN KIT		1		
K-2170		FILTER REG KIT	A - 5454	1		
K-2262		OIL SEAL W/SLINGER	19109 20807 20808	1	"FOR MECHANICAL COVER"	K-2861,K-2862
K-2366		KEY & WASHER KIT	21326 ,4300763 ,4304614	1	CONTAINS 3-SIDED KEY	
K-2468		CLUTCH INSTALLATION KIT		1	FOR USE WITH S-1659 INPUT SHAFT ASSY AND 81504 INPUT SHAFT BEARING	
K-2604		SHIFT SENSOR KIT	691743 ,4301668 ,4302725	1		
K-2805		SHIM KIT	21452 K - 2106	1		K-2861,K-2862
K-2839		-O- RING KIT		1		K-2861,K-2862
K-2856RX		REMAN EXCHANGE TRANSMISSION CONTROLLER KIT	K-2856, K-2856R	1		
K-2860		GASKET KIT		1		K-2861,K-2862
K-2861		BASIC REBUILD KIT		1		
K-2862		BASIC OVERHAUL KIT		1		
K-2908		-O- RING KIT		1	FOR SOLENOID VALVE	
K-2909		RANGE CYL COVER KIT	4301361	1		
K-2942		COUNTERSHAFT REPL KIT	4301224 ,4301225	1		
K-3209		IDLER SHAFT REPL KIT	16405 ,4302981 ,4305513	1		
K-3281		P.I.M. REPLACEMENT KIT	4301645	1		
K-3318		TOWER HARNESS KIT	691302 ,691539	1		
K-3367		OIL PUMP KIT	4301829 ,4301948 ,4303776 ,4304529 ,4304572 A - 6963 ,A - 7173	1		
K-3388		SMALL PARTS KIT		1		
K-3492		SYNCHRONIZER KIT	K - 2446	1		
K-3494		SYNCHRONIZER REPLACEMENT KIT	K - 2448	1	SLIDING CLUTCH INCLUDED IN KIT	
K-3651		OIL SEAL TOOL KIT		1		
K-3682		RANGE/SPLITTER VALVE KIT	5561801 ,5561804 ,K - 2907	1		
K-4051		RT CLUTCH HOUSING SERVICE KIT		1		
K-4125		CLUTCH INSTALLATION KIT (RT), HYDRAULIC RELEASE		1	STANDARD RT INPUT SHAFT AND YOKE FOR HYDRAULIC CLUTCH RELEASE	
S-1404		OIL FILTER	17238	1		
S-1659		INPUT SHAFT	20535 23566 4302661	1	2" PULL - USE W/FBC 20550	K-2468,K-2862,K-4125
S-1660		INPUT SHAFT	23567	1	2" PUSH - USE W/FBC 20549	
S-2257		REAR BRG COVER ASSY	4302556	1		
S-2612		SHIFT BAR HSG ASSY	4301357 ,4302747 ,S - 1990	1	COMPLETE	
S-2616		SHIFT BAR HSG ASSY	4301357 ,4302747 ,S - 1991	1	HOUSING ONLY (DOES NOT INCLUDE SPEED SENSORS)	
S-2688		MAINSHAFT ASSY	4303404 ,4303913	1		
S-2745R		REMAN XY SHIFTER ASSY	691365 ,691366 ,691381 ,A - 6859 ,A - 7332	1	COMPONENT PARTS NOT SOLD SEPARATELY	
S-2996		CASE ASSY	4301355 ,4305766 ,S - 1989	1		
S-2998		CASE ASSY	4302218 ,4305765 ,S - 2075	1	FOR USE W/INTEGRAL PUMP	

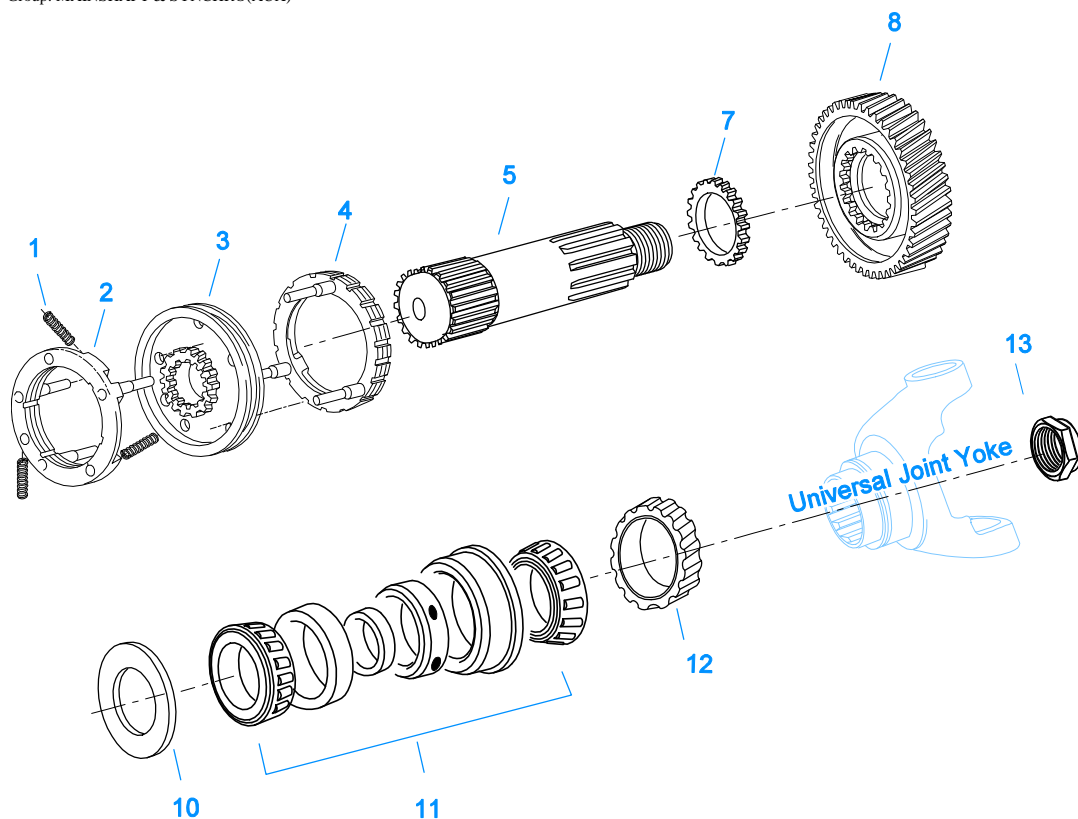

10420-1/92 Aux MS

MAINSHAFT & SYNCHRO(AUX)

Item	Current Part	Description	Replaced Part	Qty.	Notes	Kits/Assys Where Needed
1	14897	SPRING		3		K-2861,K-2862,K-3388,K-3492,K-3494
2	A-7331	SYNCHRONIZER ASSY	4304396 4304397 A - 5917	1	HI RANGE	K-3492,K-3494
3	20323	SLIDING CLUTCH		1		K-3494
4	A-7254	SYNCHRONIZER ASSEMBLY	A - 4937 A - 5876	1	LO RANGE	K-3492,K-3494
5	23022	AUXILIARY MAINSHAFT		1		
7	22899	WASHER		1		K-3388
8	4302090	REDUCTION GEAR	4301227	1		
10	22898	SPACER		1		K-3388
11	21355-BOX	BEARING	21355	1		K-2861,K-2862
12	20192	ROTOR		1		
13	22254	NUT		1		

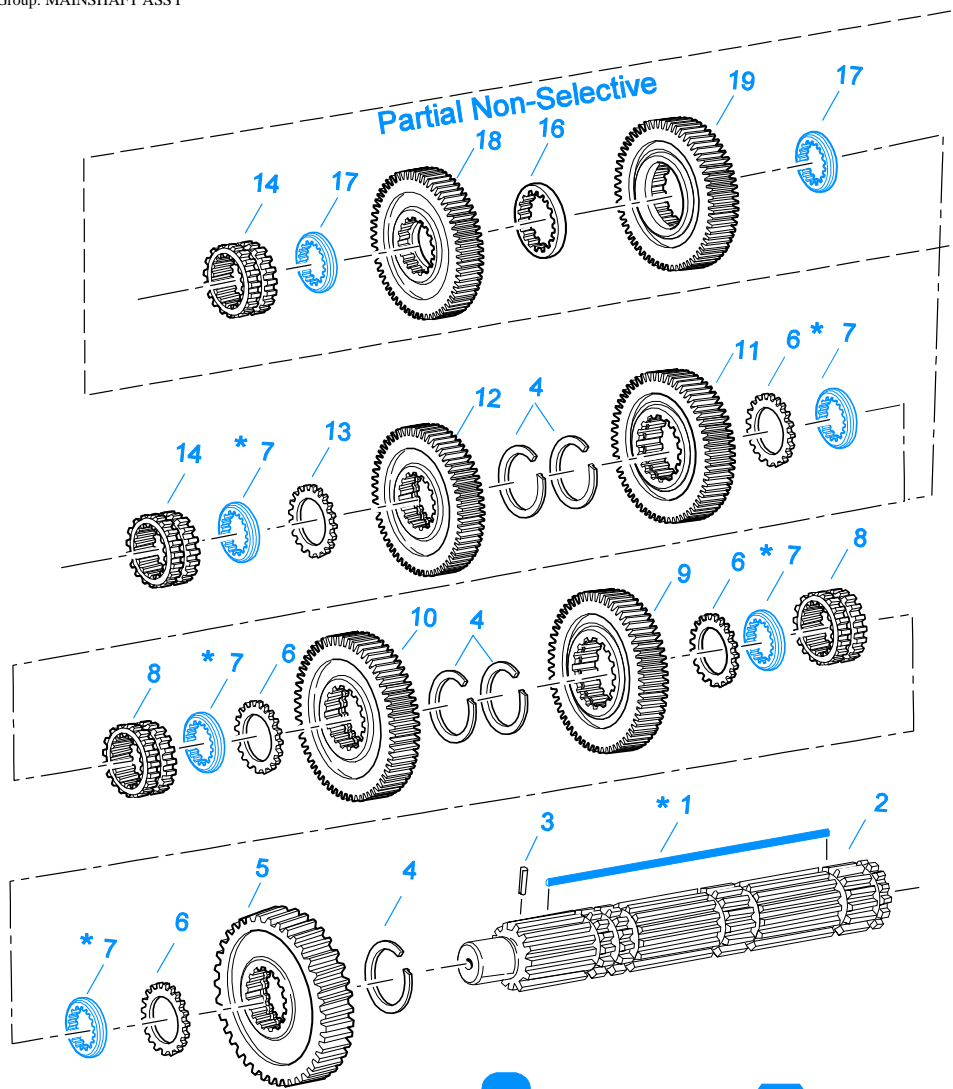

10320A-3-94 MS w/ OD

 3-Sided Key Design

 Hex (6-Sided) Key Design

*** Updating to 3-Sided Key is Recommended.**
When Updating to 3-Sided Key Replace all Washers to Match Key Design
Always Use Matching Key and Washer Sets (See Appendix - Mainshaft Washers)

MAINSHAFT ASSY

Item	Current Part	Description	Replaced Part	Qty.	Notes	Kits/Assys Where Needed
1	4304614	3-SIDED KEY	4300890	1		K-2366,K-3388
1	K-2366	KEY & WASHER KIT	21326 ,4300763 ,4304614	1	CONTAINS 3-SIDED KEY	
2	S-2688	MAINSHAFT ASSY	4303404 ,4303913	1		
3	62504	ROLL PIN		1		S-2688
4	14750	SNAP RING		5		K-2468,K-2861,K-2862,K-3388,K-4125
5	4301222	REVERSE GEAR-MAINSHAFT		1		
6	14749	SPACER		4		K-3388
7	4300382	WASHER .249-WHITE		5		K-2366,K-3388
7	4300383	WASHER .254-GREEN		5	OPTIONAL 4300382-4300387 OR 4300830 USE ANY 5 WASHERS. USE	K-2366,K-3388

Item	Current Part	Description	Replaced Part	Qty.	Notes	Kits/Assys Where Needed
7	4300384	WASHER .259-ORANGE		5	WITH 3-SIDED KEY OPTIONAL 4300382-4300387 OR 4300830 USE ANY 5 WASHERS. USE	K-2366,K-3388
7	4300385	WASHER .264-PURPLE		5	WITH 3-SIDED KEY OPTIONAL 4300382-4300387 OR 4300830 USE ANY 5 WASHERS. USE	
7	4300386	WASHER .269-YELLOW		5	WITH 3-SIDED KEY OPTIONAL 4300382-4300387 OR 4300830 USE ANY 5 WASHERS. USE	
7	4300387	WASHER .274-BLACK		5	WITH 3-SIDED KEY OPTIONAL 4300382-4300387 OR 4300830 USE ANY 5 WASHERS. USE	
7	4300830	WASHER .244-BLUE		5		K-2366,K-3388
8	4305997	SLIDING CLUTCH	4301407	2		
9	4301220	1ST GEAR-MAINSHAFT	4301219	1		
10	20381	2ND GEAR-MAINSHAFT	19268 ,4302104	1		
11	19622	3RD GEAR-MAINSHAFT	21263 ,4300246	1		
12	23102	OD GEAR-MAINSHAFT	22960 ,4300190	1		
13	22032	SPACER		1		K-3388
14	4305996	SLIDING CLUTCH	691922	1		K-2862
16	4303603	WASHER	4302397	1		
17	4302398	WASHER		2	USE 3-SIDED KEY ONLY	
18	4302393	OD GEAR-MAINSHAFT	4305070	1	USE 3-SIDED KEY ONLY	
19	4302394	2ND GEAR-MAINSHAFT	4302395	1	USE 3-SIDED KEY ONLY	

MISCELLANEOUS

Item	Current Part	Description	Replaced Part	Qty.	Notes	Kits/Assys Where Needed
4302236		SHIFT DIAGRAM LABEL		1		
71203		SILICONE LUBE		1	8 OZ (236.59 CC)-FLEET SIZE	
71204		ADHESIVE SEALANT		1	0.5 CC (SINGLE APPLICATION SIZE)	
71205		SEALANT		1	2 CC (SINGLE APPLICATION SIZE)	K-2862
71206		SILICONE LUBE		1	4 CC (SINGLE APPLICATION SIZE)	K-2839

Group: OIL COOLER

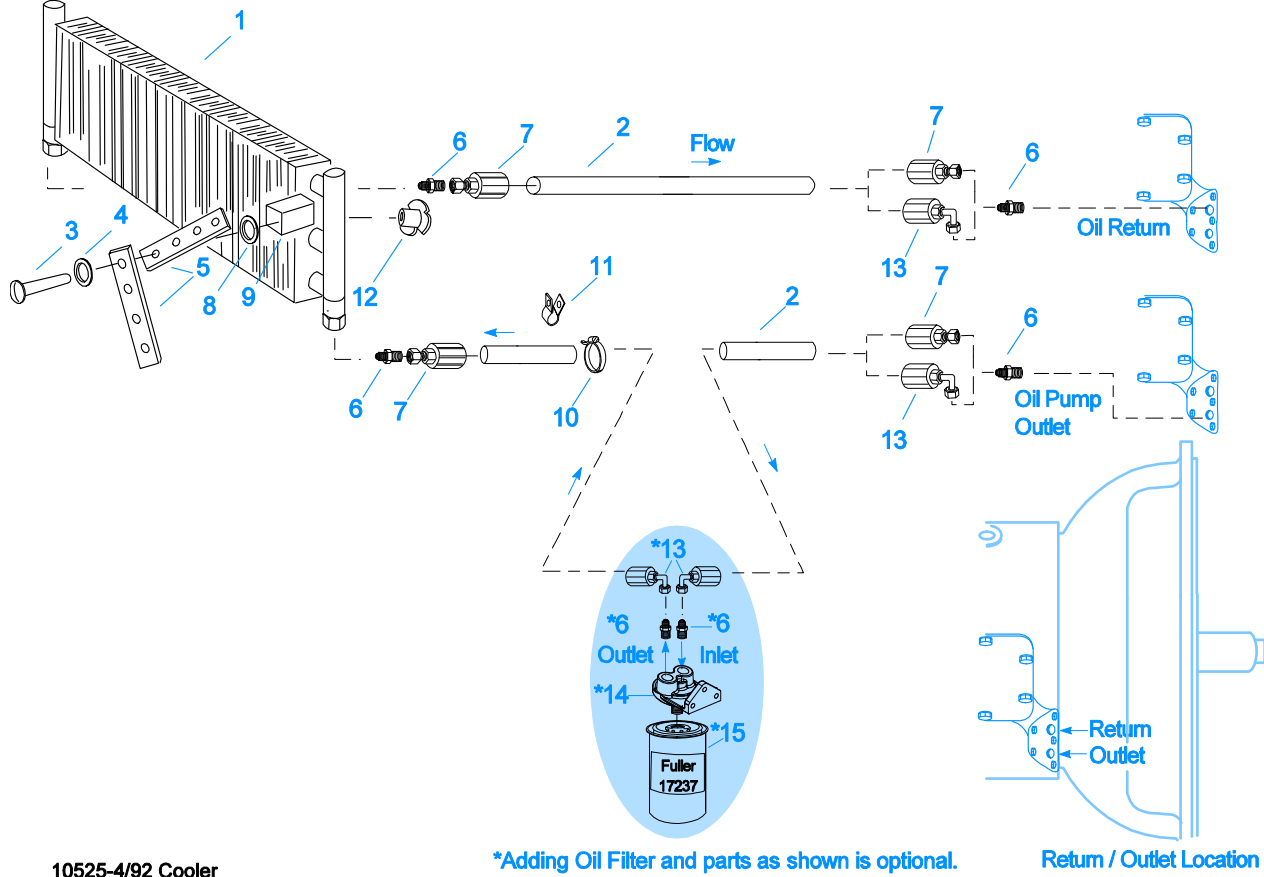

10525-4/92 Cooler

*Adding Oil Filter and parts as shown is optional.

Return / Outlet Location

OIL COOLER

Item	Current Part	Description	Replaced Part	Qty.	Notes	Kits/Assys Where Needed
1	18025	OIL COOLER		1		K-1956
2	19424	HOSE		1	25 FEET	K-1956
3	X-8-535	CAPSCREW		2	5/16"-16X2-1/2"	
4	X-3-506	LOCKWASHER		2	5/16"	
5	18211	BRACKET		4		K-1956
6	19419	CONNECTOR		6		K-1956,S-1404
7	19415	SWIVEL		4		K-1956
8	X-10-501	WASHER		2	5/16"	
9	18209	PLUG-RUBBER MOUNT		2		K-1956
10	17190	STRAP		8		K-1956
11	19423	CLAMP		5		K-1956
12	18210	NUT		2		K-1956
13	19422	ELBOW		4		K-1956
14	S-1404	OIL FILTER	17238	1		
15	17237	FILTER ELEMENT		1		S-1404

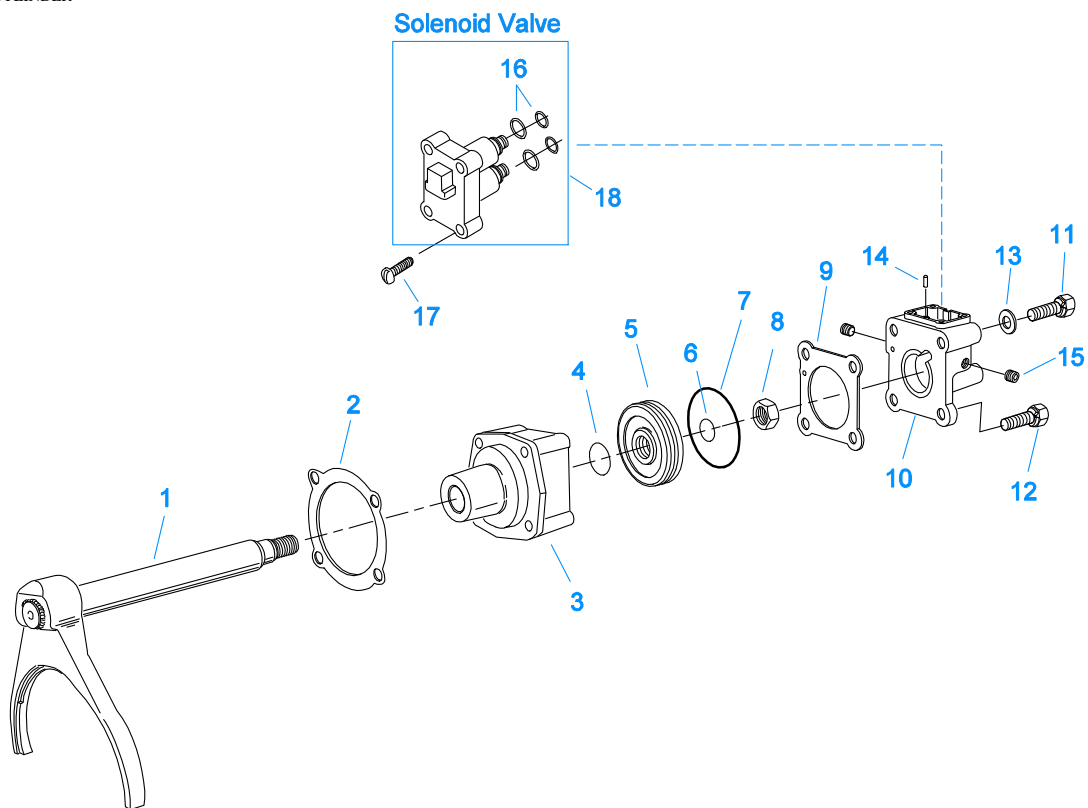

20537-12-93 AC

RANGE CYLINDER

Item	Current Part	Description	Replaced Part	Qty.	Notes	Kits/Assys Where Needed
1	A-5474	SHIFT YOKE ASSY		1		
2	14347	GASKET		1		K-2860
3	4301363	CYLINDER		1		
4	14765	-O- RING		1		K-2839
5	14341	PISTON	23353	1		
6	14345	-O- RING		1		K-2839
7	14344	-O- RING		1		K-2839
8	X-1-1010	NUT		1	5/8"-18	
9	4301377	GASKET		1		K-2839,K-2860,K-2909
10	K-2909	RANGE CYL COVER KIT	4301361	1		
11	X-8-647	CAPSCREW		2	3/8"-16X4-3/4"	
12	X-8L-605	CAPSCREW		2	3/8"-16X3"	
13	X-3-600	LOCKWASHER		2	3/8"	
14	4301373	PIN		1		
15	X-12-208	PIPE PLUG		2	1/8" NPT	
16	K-2908	-O- RING KIT		1	FOR SOLENOID VALVE	
17	X-8-264	HEX FLANGE HEAD SCREW	X 8 259	4	#10-24 X 1 1/4	
18	K-3682	RANGE/SPLITTER VALVE KIT	5561801 ,5561804 ,K - 2907	1		

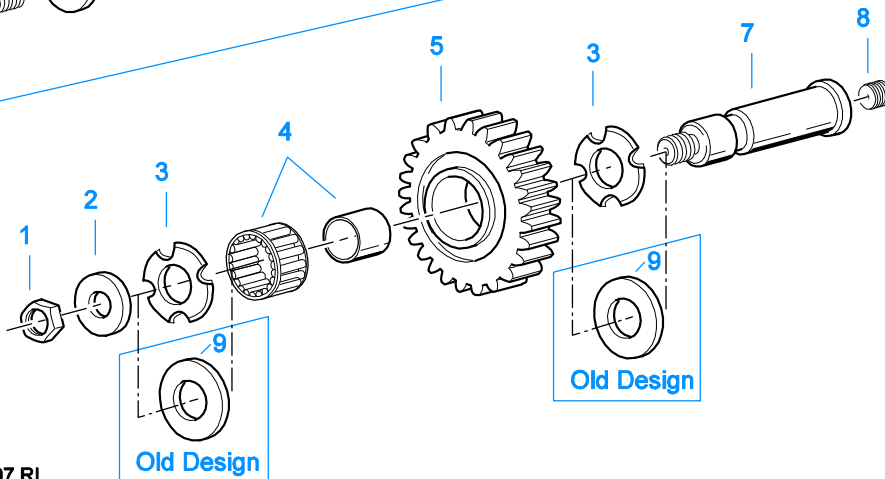
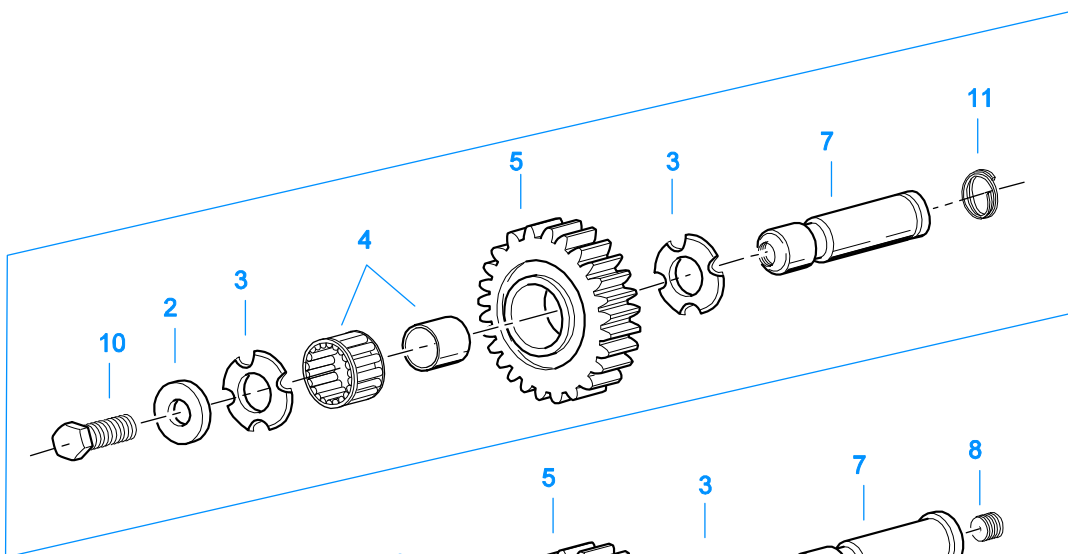
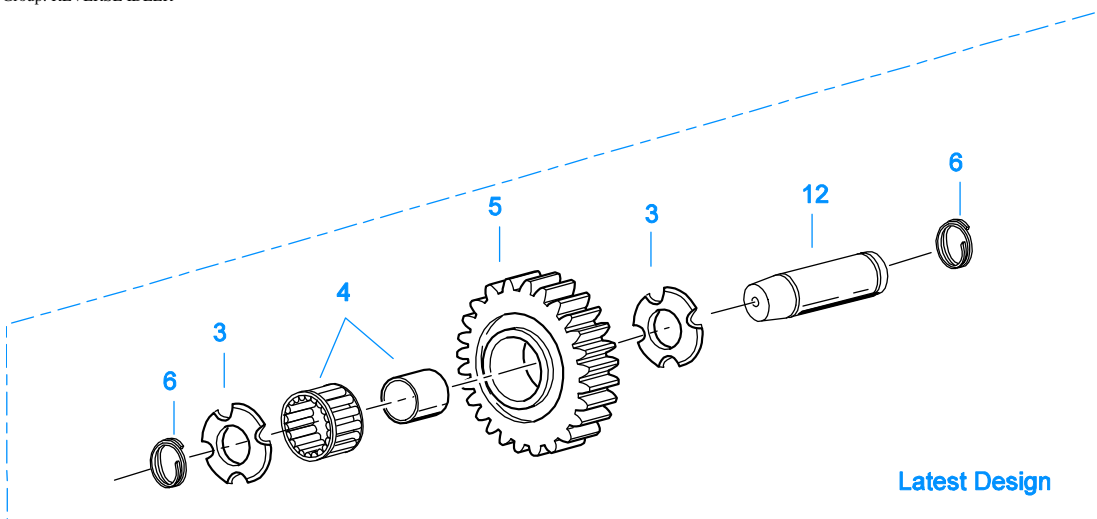

11383-5-97 RI

REVERSE IDLER

Item	Current Part	Description	Replaced Part	Qty.	Notes	Kits/Assys Where Needed
1	X-1-1008	NUT		2	5/8"-18	
2	14283	WASHER		2		
3	4302982	WASHER	14282	4		K-3209,S-2996,S-2998
4	14287	BEARING	4305020	2		K-2861,K-2862
5	4301229	REVERSE IDLER GEAR		2		
6	4303336	RETAINING RING		4		K-3209
7	K-3209	IDLER SHAFT REPL KIT	16405 ,4302981 ,4305513	2		
8	5202	PLUG		2		

Item	Current Part	Description	Replaced Part	Qty.	Notes	Kits/Assys Where Needed
9	14282	NO LONGER AVAILABLE		4		
10	X-7-1008	CAPSCREW		2	5/8"-18X1-1/4	
11	4303336	RETAINING RING		2		K-3209
12	4305513	IDLER SHAFT		2		K-3209

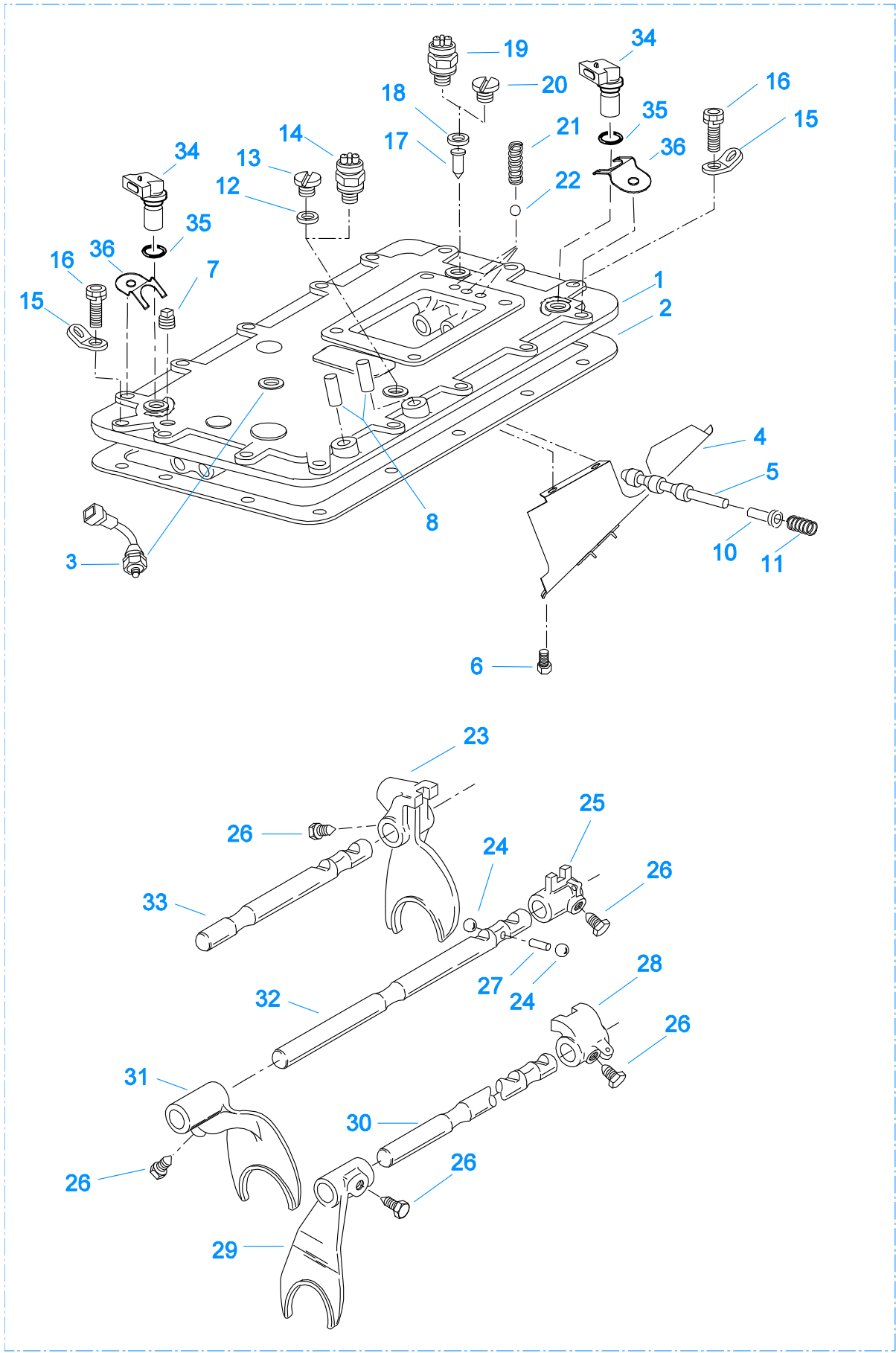

999

SHIFT BAR HOUSING

Item	Current Part	Description	Replaced Part	Qty.	Notes	Kits/Assys Where Needed
1	S-2616	SHIFT BAR HSG ASSY	4301357 ,4302747 ,S - 1991	1	HOUSING ONLY (DOES NOT INCLUDE SPEED SENSORS)	
2	4302676	GASKET	14918	1		K-2860,S-2612,S-2616
3	K-2604	SHIFT SENSOR KIT		1	NOT INCLUDED IN COMPLETE SHIFT BAR HOUSING ASSEMBLY (999)	
4	20070	OIL TROUGH		1		S-2612
5	20332	AIR VALVE SHAFT	17177	1		S-2612
6	X-8-423	CAPSCREW		2	1/4"-20X1/2"	
7	X-12-603	PIPE PLUG	X12 602	1	3/8" NPT	
8	4301378	DOWEL PIN		2		S-2612
10	21966	PLUNGER		1		
11	4301372	SPRING		1		
12	17179	GASKET		1		S-2612,S-2616
13	4303655	PLUG	17178	1		S-2612,S-2616
14	22941	NEUTRAL LIGHT SWITCH	12639	1	SWITCH NORMALLY CLOSED	
15	20815	LIFTING EYE	17105	2		
16	X-8L-602	CAPSCREW		2	3/8"-16X1-1/2"	
16	X-8L-604	CAPSCREW		16	3/8"-16X1-1/4"- OR USE 14 PCS OF X-8L-604 WITH 2 PCS OF X-8L-602	
17	15899	PIN		1		
18	15900	GASKET		1		K-2604,S-2612,S-2616
19	22940	REVERSE LIGHT SWITCH	16830	1	SWITCH NORMALLY OPEN	
20	4303656	PLUG	15917	1		S-2612,S-2616
21	1069	SPRING		3		K-2862,K-3388,S-2612
22	X-14-800	STEEL BALL		3	1/2"	
23	691712	SHIFT YOKE	4301376	1	REVERSE/LO	S-2612
24	X-14-1200	STEEL BALL		2	3/4"	
25	14658	SHIFT BLOCK		1	1ST/2ND	S-2612
26	3220	LOCKSCREW		5		S-2612
27	1634	INTERLOCK PIN		1		K-3388,S-2612
28	14659	SHIFT BLOCK		1	3RD/OD	S-2612
29	691601	SHIFT YOKE	4302212	1	3RD/OD	S-2612
30	4301366	YOKE BAR		1	3RD/OD	S-2612
31	691600	SHIFT YOKE	4302994	1	1ST/2ND	S-2612
32	4301365	YOKE BAR		1	1ST/2ND	S-2612
33	4301364	YOKE BAR		1	REVERSE/LO	S-2612
34	K-3231	SPEED SENSOR KIT	A - 6398 ,A - 6724	2	SINGLE PICK-UP (2 PIN)	
35	14142	-O- RING		2		S-2257,S-2612
36	4302746	SPRING CLIP		2		K-3231,S-2612
999	S-2612	SHIFT BAR HSG ASSY	4301357 ,4302747 ,S - 1990	1	COMPLETE	

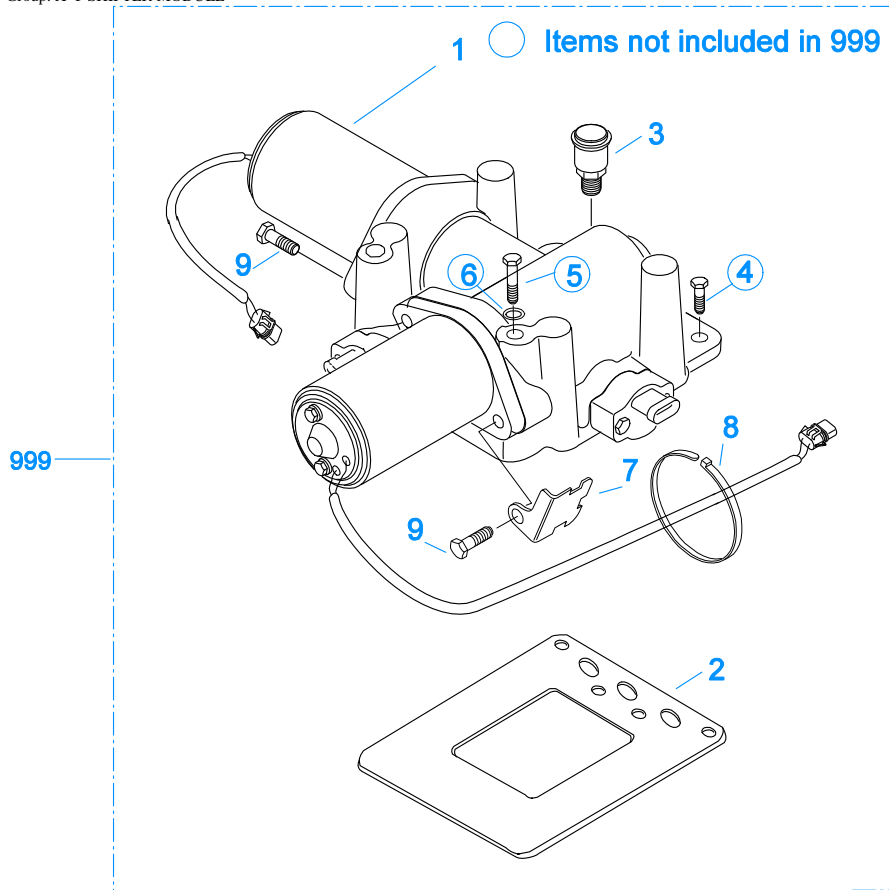

20228-11-99 XY Shf

X-Y SHIFTER MODULE

Item	Current Part	Description	Replaced Part	Qty.	Notes	Kits/Assys Where Needed
1	S-2745R	REMAN XY SHIFTER ASSY	691365 ,691366 ,691381 ,A - 6859 ,A - 7332	1	COMPONENT PARTS NOT SOLD SEPARATELY	
2	4305294	GASKET	4303431	1		K-2860
3	4304602	BREATHER	23605	1	1/4" NPT	
4	X-8L-600	CAPSCREW		2	3/8"-16X1"	
5	X-8-624	CAPSCREW		2	3/8"-16X4"	
6	X-3-600	LOCKWASHER		2	3/8"	
7	4301302	BRACKET		1		
8	5559348	TY-RAP		1		K-3352,K-3682
9	X-8C-500	CAPSCREW		4	18X1-1/4"	
999	S-2745R	REMAN XY SHIFTER ASSY	691365 ,691366 ,691381 ,A - 6859 ,A - 7332	1	COMPONENT PARTS NOT SOLD SEPARATELY	

