



Eaton Fuller T-11605B Transmission Parts Manual

This is Eaton Fuller T-11605B Transmission parts manual brought to you by Pro Gear and Transmission to assist you identifying the parts for your Eaton / Fuller transmission unit.

If you need any assistance identifying the correct Eaton / Fuller unit for your truck and equipment, contact your Eaton replacement parts specialists at Pro Gear and Transmission.

Pro Gear stocks every part for your Eaton transmission including: Valve Assemblies, Synchronizers, Yoke Assemblies, O-Ring Kits, Drive Gears, Gaskets, Bearing and Seal Kits, and much more.

Pro Gear and Transmission has same day shipping and thousands of products in stock and ready to ship internationally for your next project.

For parts or service contact the Eaton transmission specialists at Pro Gear & Transmission, Inc.

 CALL US

 EMAIL US

 VISIT MODEL PAGE

 VISIT ONLINE STORE

Fuller Medium Heavy Transmissions TRSM0200

October 2007



Powering Business Worldwide

BACKED BY

Roadranger

TABLE OF CONTENTS

Model Designations
Description
Specifications
Lubrication
Preventive Maintenance
Torque Recommendations
Timing
Precautions
Shifting Controls
Removal and Disassembly
Changing input Shaft
Reassembly and installation
Tool Reference

MODEL DESIGNATIONS

MODEL DESIGNATIONS

“T” = Twin Countershaft

“O” = Used as a letter, denotes Overdrive model

“11” x 100 = 1100 lbs.-ft. torque capacity rating

“6” = Denotes “multi-mesh” gearing

“05” = Five forward speeds

“A”, “B”, etc. = Following numbers indicates a specific set of ratios

Since the models in the T-11605 series are identical in construction, references in this manual apply to all models unless stated otherwise. This includes models not listed above which may have other ratio combinations, designated by letters following the numerals.

ADDITIONAL LITERATURE

The following additional literature is available for the transmissions covered in this manual. Write: Marketing Communications, Eaton Corporation, Transmission Division, North American Headquarters, P.O. Box 4013, Kalamazoo, Michigan 49003. Phone: (616) 342-3344.

P-533 Illustrated Parts List

16848 Shift Label T-1 1605

102 Trouble Shooting Guide

16849 Shift Label TO-1 1605

121 Lubrication Recommendations

DESCRIPTION

THE T-11605 SERIES TRANSMISSIONS

The New Generation T-11605 series transmissions, like the proven T-905 series they supersede, are designed with five forward speeds and one reverse for medium to heavy duty on-highway vehicles. The significant difference, however, is that most of the coarse pitch conventional gearing of the T-905 series has been replaced by the fine pitch "multi-mesh" gearing of the New Generation Series.

Multi-mesh gearing means there are two or three teeth per gear always in contact during torque transfer, instead of just one or two as with conventional gearing. With reduced stress on individual gear teeth, this multiple contact insures better distribution of engine torque through a smoother, less-noisier power flow that ultimately extends gear and bearing life.

The twin countershaft design, which splits torque equally between the two shafts to provide a high torque capacity to weight ratio, remains unchanged. Because of torque splitting, each gear set carries only half the load, greatly reducing the face width of each gear. Only the countershaft gears which mate with multi-mesh mainshaft gears have been changed to the new gearing concept.

Another unique design feature, also unchanged from the T-905 series, is the floating gear principle. The mainshaft gears, when not engaged, "float" between the countershaft gears, eliminating the need for gear sleeves and bushings. Only the 1st-speed and reverse gears are of the conventional gearing type. The remaining forward speed gears of the mainshaft have been changed to the new multi-mesh gearing concept.

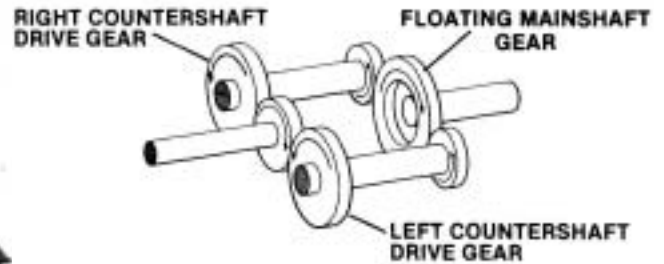
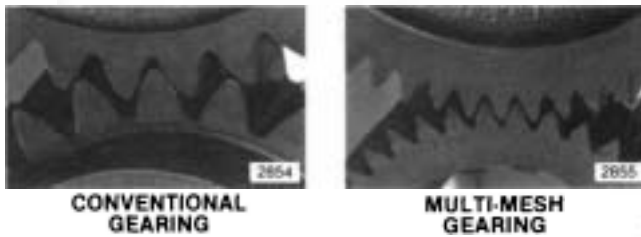

2865

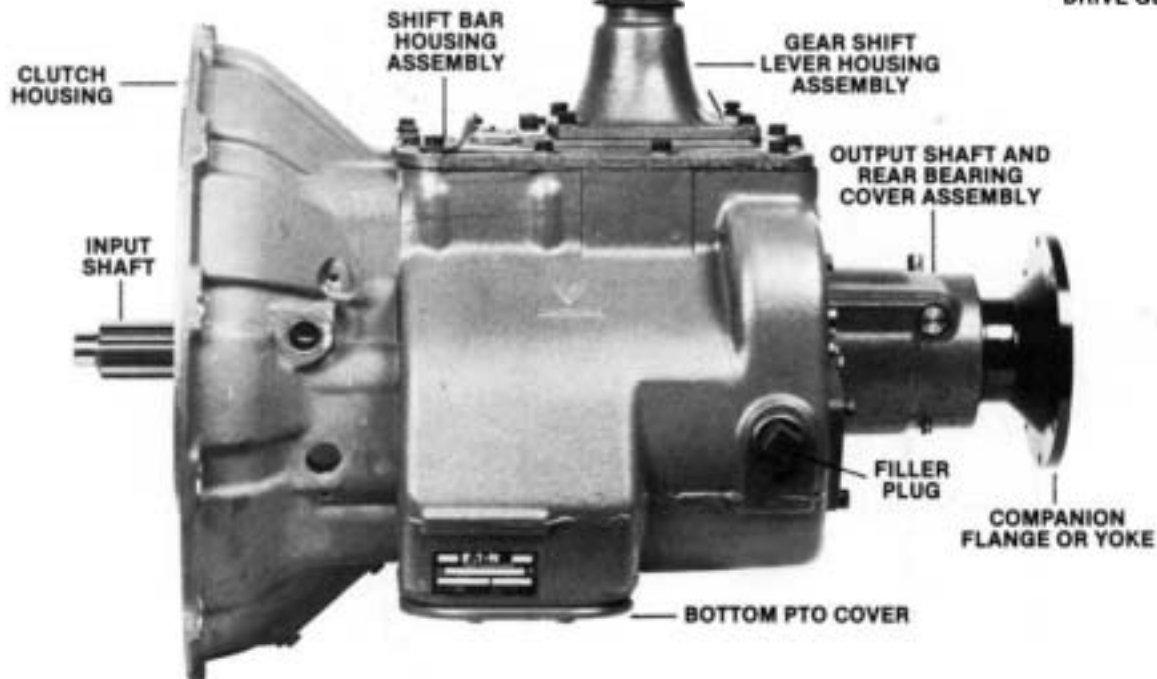

SPECIFICATIONS

GEAR RATIOS

Speed	MODELS									
	T-11605A	TO-11605A	T-11605B	TO-11605B	T-11605C	TO-11605C	T-11605D	TO-11605DI	T-11605M	T-11605F
5th	1.00	.66	1.00	.86	1.00	.85	1.00	.76	1.00	1.00
4th	1.52	1.00	1.16	1.00	1.18	1.00	1.31	1.00	1.31	1.46
3rd	2.39	1.57	2.04	1.75	2.12	1.80	2.05	1.57	1.75	2.12
2nd	3.75	2.46	3.75	3.23	3.90	3.32	3.23	2.46	2.66	3.90
1st	6.35	4.16	6.35	5.46	7.20	6.12	5.46	4.16	5.46	7.20
Reverse	6.48	4.25	6.48	5.57	7.09	6.03	5.57	4.25	5.57	7.09

GEAR CHART

MODEL	DRIVE GEAR	C.S. DRIVE GEAR	M.S. 4TH	C.S. 4TH	M.S. 3RD	C.S. 3RD	M.S. 2ND	C.S. 2ND	M.S. 1ST	C.S. WITH 1ST	M.S. REV.	C.S. WITH REV.
T-11605A	40-T 19646	75-T 19647	52-T 19171	64-T 19175	56-T 19612	44-T 19613	66-T 19177	33-T 19178	44-T 19082	13-T 14720	38-T 14748	11-T 14720
TO-11605A	52-T 19168	64-T 19167	40-T 19648	75-T 19649	56-T 19612	44-T 19613	66-T 19177	33-T 19178	44-T 19082	13-T 14720	38-T 14748	11-T 14720
TO-11605B	40-T 19646	75-T 19647	44-T 19182	71-T 19181	50-T 19620	46-T 19621	66-T 19177	33-T 19178	44-T 19082	13-T 14720	38-T 14748	11-T 14720
TO-11605B	44-T 19166	71-T 19164	40-T 19648	75-T 19649	50-T 19620	46-T 19621	66-T 19177	33-T 19178	44-T 19082	13-T 14720	38-T 14748	11-T 14720
T-11605C	40-T 19191	78-T 19190	44-T 19634	73-T 19635	50-T 19620	46-T 19621	66-T 19177	33-T 19178	48-T 15470	13-T 15475	40-T 15480	11-T 15475
TO-11605C	44-T 19636	73-T 19637	40-T 19194	78-T 19186	50-T 19620	46-T 19621	66-T 19177	33-T 19178	48-T 15470	13-T 15475	40-T 15480	11-T 15475
T-11605D	44-T 19166	71-T 19164	52-T 19171	64-T 19175	56-T 19612	44-T 19613	66-T 19177	33-T 19178	44-T 19082	13-T 14720	38-T 14748	11-T 14720
TO-11605D	52-T 19168	64-T 19167	44-T 19182	71-T 19181	56-T 19612	44-T 19613	66-T 19177	33-T 19178	44-T 19082	13-T 14720	38-T 14748	11-T 14720
T-11605M	44-T 19166	71-T 19164	52-T 19171	64-T 19175	50-T 19620	46-T 19621	56-T 19624	34-T 19625	44-T 19082	13-T 14720	38-T 14748	11-T 14720
T-11605F	40-T 19191	78-T 19190	50-T 19984	67-T 19985	50-T 19620	46-T 19621	66-T 19177	33-T 19178	48-T 15470	13-T 15475	40-T 15480	11-T 15475

M.S. = MAINSHAFT
C.S. = COUNTERSHAFT

GEAR SHIFT PATTERN

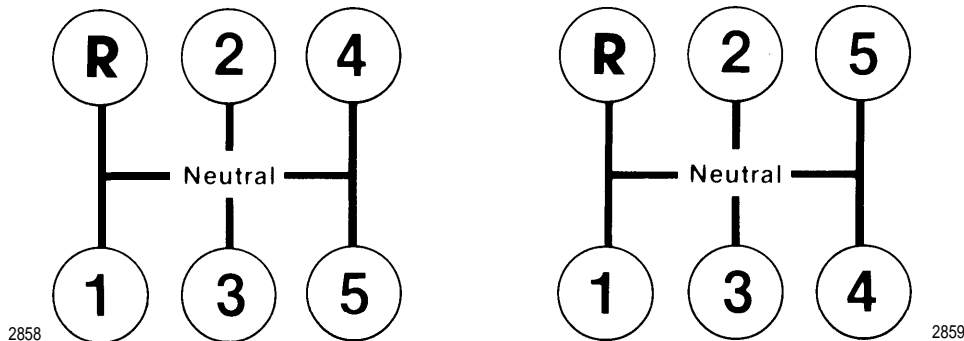

SPECIFICATIONS

Clutch Release Mechanism—

Push-type clutches-single and 2-Plate — Clutch release bearing carrier, release bearing, extended front bearing cover, release yoke, pedal shafts and pedal adjusting arm furnished.

Pull-Type 2-Plate Clutches — Flat bearing cover machined for clutch brake furnished. Secure release yoke, pedal shafts, and pedal adjusting arm from clutch manufacturer.

Power Take-Off—

Openings—SAE Standard.

Right Side—Regular duty type, 6-bolt, short length.

Bottom—Heavy duty type, 8-bolt.

PTO Gears—

Right Side—45-tooth, 6/8 pitch gear.

Bottom—47-tooth, 6/8 pitch gear.

PTO Drive Gear Speeds—

Both openings, turning at engine speed:

T-11605A, T-11605 B533

TO-11605A, TO-11605D813

TO-11605B, T-11605D,

 T-11605 M619

T-11605C, T-11605 F513

TO-11605C603

Constant mesh type PTO required on all overdrive models, both openings; on T-11605C models, both openings; and on T-11605B right side. (PTO gears are conventional mesh, not multi-mesh.)

Torque Capacity—

Diesel engines up to 370 hp, 1150 lbs.-ft. torque (1559 N.m).

Torque rating is to be used as a guide and not as an approval. For an approval, submit complete vehicle specifications as outlined on Specification Form No. 62-14.

Speedometer Drive—

Provision is made in the rear bearing cover for the installation of speedometer gears and attachment of cable.

Reverse Light Switch—

Provision is made in the shift bar housing for the installation of a reverse light switch.

Weight—

With Standard Controls, SAE No. 1 aluminum clutch housing, less clutch release parts—429 lbs. (195 Kg).

Oil Capacity—

Approximately 22 pints (10 Liters), depending upon inclination of engine and transmission.

Note: Fill to level of case filler opening.

Magnetic Oil Cleaners—

Two magnetic discs are installed in bottom of case to catch and hold metallic particles deposited in the oil.

LUBRICATION

PROPER LUBRICATION . . . THE KEY TO LONG TRANSMISSION LIFE

Proper lubrication procedures are the key to a good all-round maintenance program. If the oil is not doing its job, or if the oil level is ignored, all the maintenance procedures in the world are not going to keep the transmission running or assure long transmission life.

Oil is important, because here are some of the things it must do:



- Provide a protective film —To protect surface of heavily loaded parts such as gear teeth and bearings, thus preventing metal to metal contact which causes scoring, scuffing and seizure.

2822

- Act as a coolant—To dissipate heat.

- Have sufficient fluidity—To follow, coat and cushion all loaded surfaces.

- Be chemically stable—To withstand heat and agitation without separation, gumming-up, oxidizing or corroding.

- Be non-foaming—To prevent excessive foam and increased volume under severe conditions.

- Be free of sediment and water—To prevent sludge and rust.

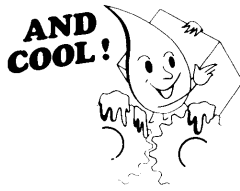

2823

Fuller Transmissions are designed so that the internal parts operate in a bath of oil circulated by the motion of gears and shafts. Grey iron parts have built-in channels where needed, to help lubricate bearings and shafts.

Thus, all parts will be amply lubricated if these procedures are closely followed:

1. Maintain oil level. Inspect regularly.
2. Change oil regularly.
3. Use the correct grade and type of oil.
4. Buy from a reputable dealer.

Lubrication Change and Inspection HIGHWAY USE

First 3,000 to 5,000 miles (4827 to 8045 Km) Change transmission oil on new units.

Every 10,000 miles (16090 Km) Inspect Oil Level. Check for leaks.

Every 50,000 miles (80450 Km) Change transmission oil.

OFF-HIGHWAY

First 30 hours Change transmission oil on new units.

Every 40 hours Inspect oil level. Check for leaks.

Every 500 hours Change transmission oil where severe dirt conditions exist.

Every 1,000 hours Change transmission oil (Normal of off-highway use).

Change oil filter element, if so equipped, at each oil change,

Recommended Lubricants

Type	Grade (SAE)	Ambient Temperature
Heavy Duty Engine Oil	50	Above 10°F.
MIL-L-2104C or MIL-L-46152	40	Above 10°F.
or API-SF or API-CD	30	Below 10°F.
Mineral Gear Oil with rust and oxidation inhibitor	90	Above 10°F.
API-GL-1	80W	Below 10°F.
Mild EP Gear Oil*	90	10° F. to 100°F.
MI L-L-2105 or API-G L-4	80W	-15° F. to 70°F.
Multipurpose Gear Oil*	85W140	Above 10°F.
	80W140	Above — 15°F.
	90	10°F. to 100°F.
MIL-L-2105B or MIL-L-2105C	80W90	— 15° F. to 100°F.
or API-G L-5	80W	— 15°F. to 70°F.
	75W	— 40°F. to —150°F.

2824

*Mild EP gear oil or multi-purpose gear oil are not recommended when lubricant operating temperatures are above 230°F (110°C).

Do not use oil additives, friction modifiers or synthetic lubricants.

Fahrenheit to Celsius: — 40°F = — 40°C
— 15°F = — 26°C
10°F = 12°C
70°F = 21°C
100°F = 38°C

LUBRICATION

Proper Oil Level

Make sure oil is level with filler opening. Because you can reach oil with your finger does not mean oil is at proper level.

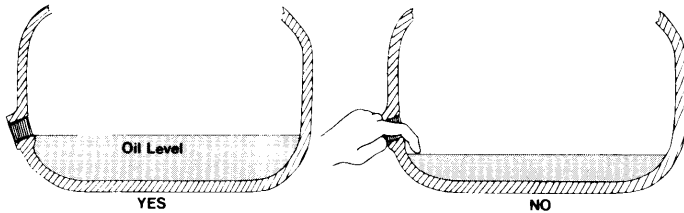

2825

Draining Oil

Drain transmission while oil is warm. To drain oil remove the drain plug at bottom of case. Clean the drain plug before re-installing.

Refilling

Clean area around filler plug and remove plug from side of case. Fill transmission to the level of the filler opening. If transmission has two filler openings, fill to level of rear opening on single countershaft models; fill to level of both openings on twin countershaft models.

The exact amount of oil will depend on the transmission inclination and model. *In every instance, fill to the level of the filler opening.*

Do not over fill—this will cause oil to be forced out of the case through mainshaft openings.

Adding Oil

It is recommended that types and brands of oil not be intermixed because of possible incompatibility.

Operating Temperatures

The Transmission should not be operated consistently at temperatures above 250° F (120°C). However, intermittent operating temperatures to 300° F (149°C) will not harm the transmission. Operating temperatures above 250°F increase the lubricant's rate of oxidation and shortens its effective life. When the transmission is operated intermittently above 250° F, heavy duty engine oil **provides the best oxidation resistance. When the average operating temperature** is above 250°F, the transmission may require more frequent oil changes or external cooling.

The following conditions in any combination can cause operating temperatures of over 250°F: (1) operating consistently at slow speeds, (2) high ambient temperatures, (3) restricted air flow around transmission, (4) exhaust system too close to transmission, (5) high horsepower, overdrive operation.

External oil coolers are available to **reduce** operating temperatures. For more information, visit www.pgtruckparts.com or call 1-800-872-1911. Proper lubrication is essential for the life of your transmission. The above operating conditions are encountered.

Proper Lubrication Levels

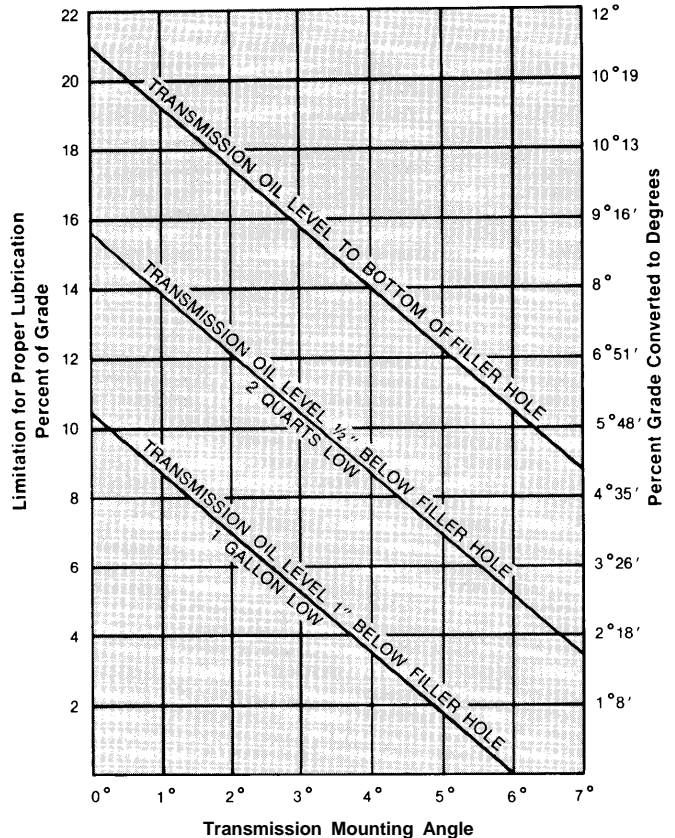

2826

If the transmission operating angle is more than 12 degrees, improper lubrication can occur. The operating angle is the transmission mounting angle in the chassis plus the percent of upgrade (expressed in degrees).

The above chart illustrates the safe percent of upgrade on which the transmission can be used with various chassis mounting angles. For example: If you have a 4 degree transmission mounting angle, then 8 degrees (or 14 percent of grade) is equal to the limit of 12 degrees. If you have a 0 degree mounting angle, the transmission can be operated on a 12 degree (21 percent) grade.

Anytime the transmission operating angle of 12 degrees is exceeded for an extended period of time the transmission should be equipped with an oil pump or cooler kit to insure proper lubrication.

Note on the chart the effect low oil levels can have on safe operating angles. Allowing the oil level to fall 1/2" below the filler plug hole reduces the degree of grade by approximately 3 degrees (5.5 percent).

Proper Lubrication Levels are Important!

PREVENTIVE MAINTENANCE

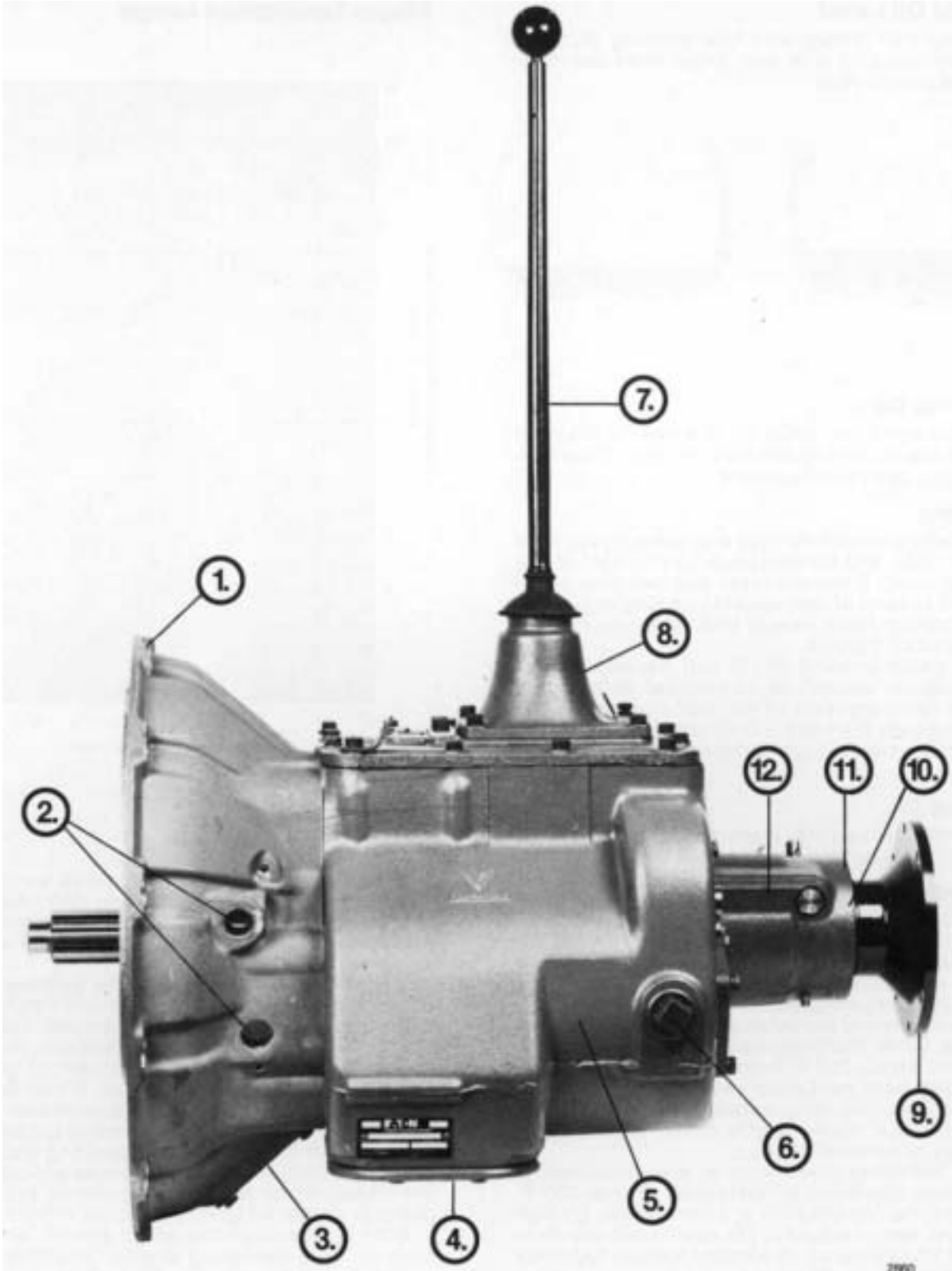

PREVENTIVE MAINTENANCE

PREVENTIVE MAINTENANCE CHECK CHART

CHECKS WITHOUT PARTIAL DISASSEMBLY OF CHASSIS OR CAB

1. Clutch Housing Mounting

- a. Check all capscrews in bolt circle of clutch housing for looseness.

2. Clutch Pedal Shaft and Bores

- a. Pry upward on shafts to check wear.
- b. If excessive movement is found, remove clutch release mechanism and check bushings in bores and wear on shafts.

3. Clutch Release Bearing

- a. Remove hand hole cover and check radial and axial clearance in release bearing.
- b. Check relative position of thrust surface of release bearing with thrust sleeve on push type clutches.

4. Capscrews and Gaskets

- a. Check all capscrews, especially those on PTO covers and rear bearing covers for looseness which would cause oil leakage. See Torque Recommendations Section.
- b. Check PTO opening and rear bearing covers for oil leakage due to faulty gasket.

5. Gear Lubricant

- a. Change at specified service intervals.
- b. Use only gear oils as recommended. See Lubrication Section.

6. Filler and Drain Plugs

- a. Remove filler plug and check level of lubricant at specified intervals. Tighten filler and drain plugs securely.

7. Gear Shift Lever

- a. Check for looseness and free play in housing. If lever is loose in housing, proceed with Check No. 8.

8. Gear Shift Lever Housing Assembly

- a. Remove the gear shift lever housing assembly from transmission.
- b. Check tension spring and washer for set and wear.
- c. Check the gear shift lever pivot or spade pin and pin slot for wear.
- d. Check bottom end of gear shift lever for wear and check slot of yokes and blocks in shift bar housing for wear at contact points with shift lever.

CHECKS WITH DRIVE LINE DROPPED

9. Universal Joint Companion Flange or Yoke Nut

- a. Check for tightness. Tighten to recommended torque.

CHECKS WITH UNIVERSAL JOINT COMPANION FLANGE OR YOKE REMOVED

10. Splines on Output Shaft

- a. Check for wear from movement and chucking action of the universal joint companion flange or yoke.

11. Mainshaft Rear Bearing Cover

- a. Check oil seal for wear.

12. Output Shaft

- a. Pry upward against output shaft to check radial clearance in mainshaft rear bearing.

TORQUE RECOMMENDATIONS

Correct torque application is extremely important to assure long transmission life and dependable performance. Over-tightening or under-tightening can result in a loose installation and, in many instances, eventually cause damage to transmission gears, shafts, and/or bearings. Use a torque wrench whenever possible to ensure proper ft.-lbs. ratings. Do not torque capscrews dry.

Recommended torque ratings, location, and thread sizes of capscrews and nuts incorporated into these transmissions are provided on the following illustrations.

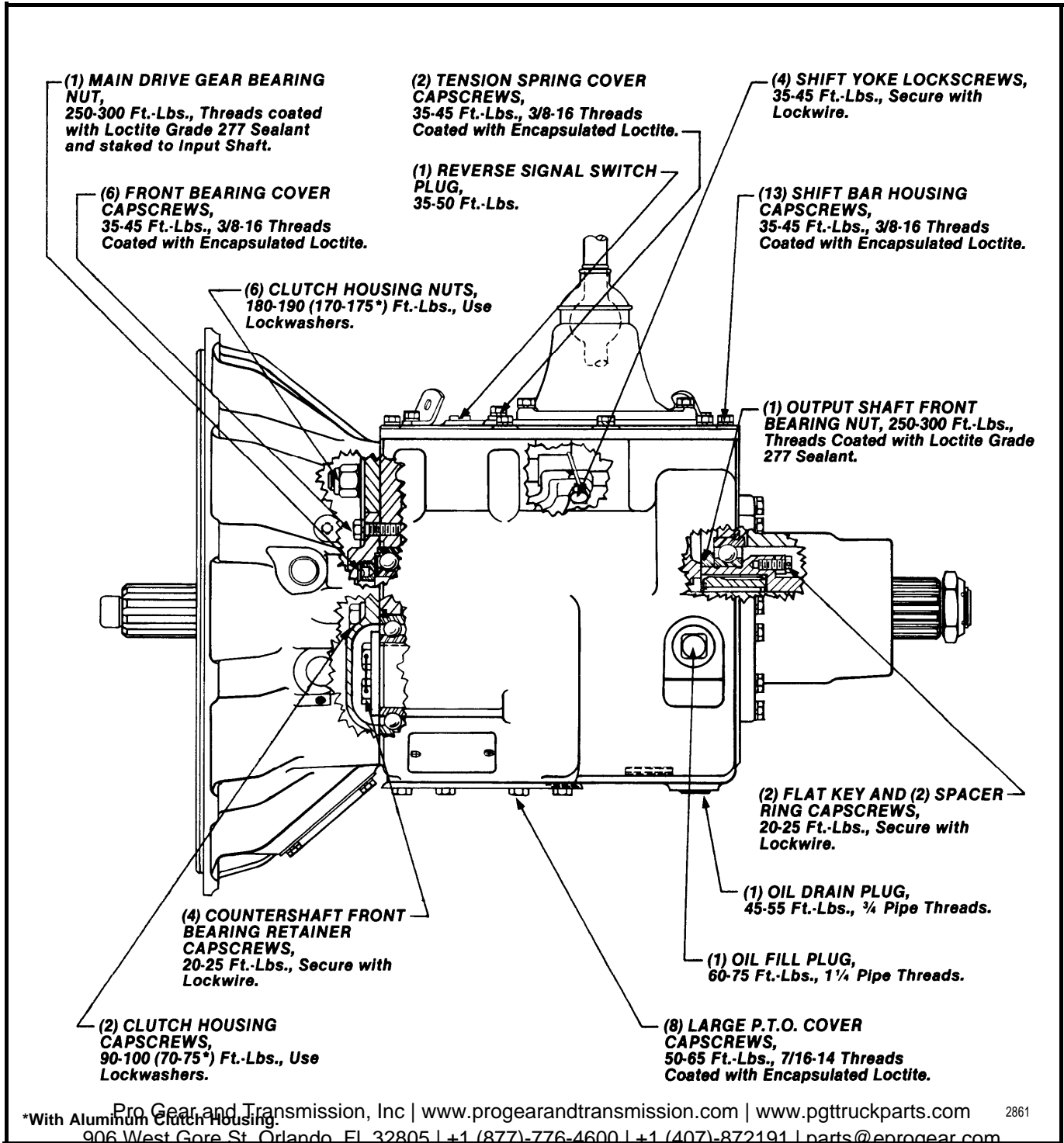

TORQUE RECOMMENDATIONS

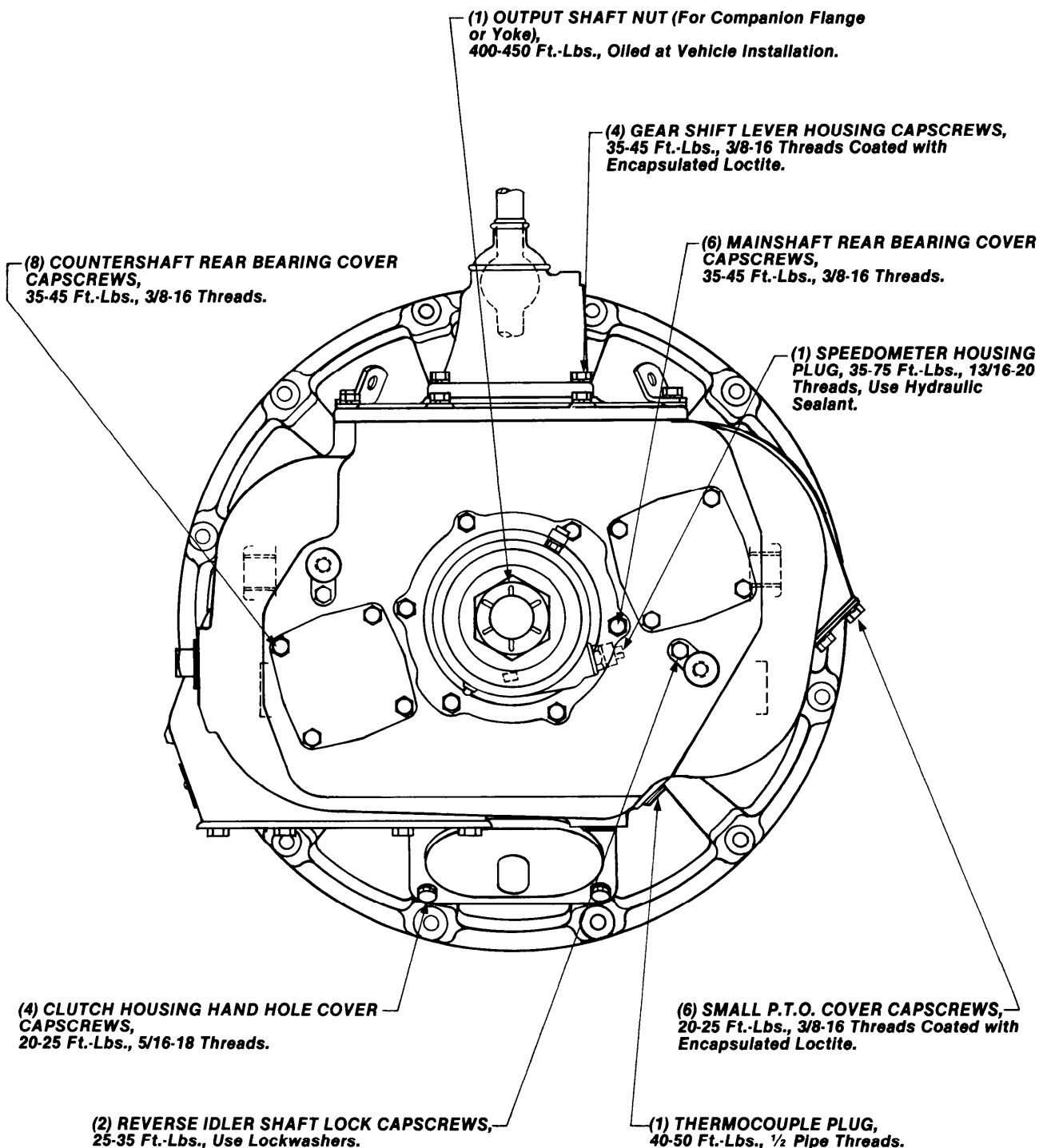

TIMING

PROPER TIMING PROCEDURES

Like other Fuller twin countershaft models, the T-11605 series transmissions are “timed” at assembly. Consequently, when the rebuilding of these units is called for, it is essential that proper timing procedures are carried out during reassembly and installation. Proper timing assures that the countershaft gear teeth will come into contact with the mating mainshaft gear teeth at the same time, allowing the mainshaft gears to center on the mainshaft and split the load between the countershaft gear assemblies. If improperly timed, however, the mainshaft gears would climb out of equilibrium, resulting in unequal tooth contact between meshing gears that would lead to more serious damage occurring to the transmission later.

By design, the timing of only one set of gears is necessary—the drive gear set. It is a rather simple procedure, consisting of marking the proper teeth of the main and countershaft drive gears prior to installation of the complete assemblies in the case and meshing those marked gear teeth during assembly.

Carefully following the step-by-step procedures given here should enable even the most inexperienced persons in transmission rebuilding to successfully and properly time these units.

A. Marking countershaft drive gear teeth.

1. Prior to placing each countershaft assembly into case, clearly mark on each drive gear the gear tooth which is directly over the keyway in gear. (See illustration A.) This tooth is stamped with an “O” to aid identification.

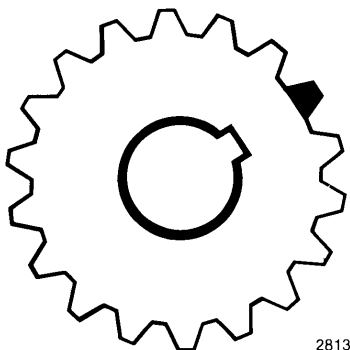

A. TOOTH ON COUNTERSHAFT DRIVE GEAR

Pro Gear and Transmission, Inc | www.progearandtransmission.com | 906 West Orange Blvd, Orlando, FL 32805 | +1 (877)-776-4600 | +1 (407) 249-1100 | progear.com

B. Marking main drive gear teeth.

1. Mark *any* two adjacent teeth on the main drive gear.
2. Mark the two adjacent teeth on the main drive gear which are directly opposite the first set marked. There should be an equal number of teeth between the markings on each side of gear. (See Illustration B.)

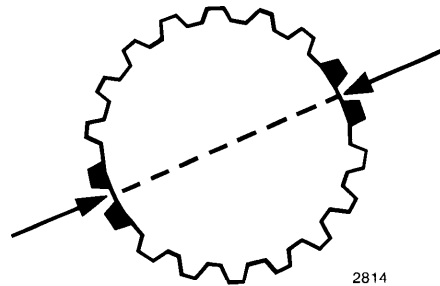

B. MAIN DRIVE GEAR TEETH CORRECTLY MARKED FOR TIMING

C. Meshing marked countershaft drive gear teeth with marked main drive gear teeth. (After installing main drive gear and mainshaft assemblies, the countershaft bearings are installed to complete countershaft installation.)

1. When installing bearings on the left countershaft, mesh the marked countershaft drive gear tooth between two marked teeth on the main drive gear. Repeat the procedure when installing the right countershaft bearings. (See Illustration C.)

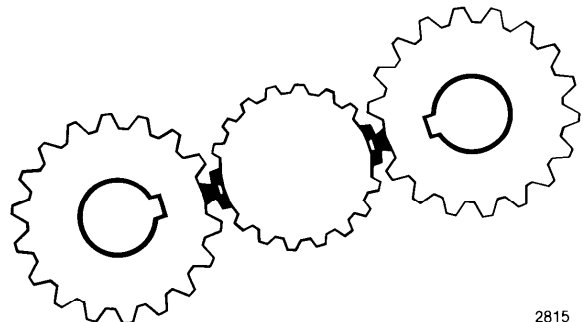

2815

Pro Gear and Transmission, Inc | www.progearandtransmission.com | 906 West Orange Blvd, Orlando, FL 32805 | +1 (877)-776-4600 | +1 (407) 249-1100 | progear.com

PRECAUTIONS

INSPECTION (Cent'd.)

C. SPLINES

1. Check splines on all shafts for wear. If sliding clutch gears, companion flange, or clutch hub have worn into the sides of the splines, replace the specific shaft affected.

D. TOLERANCE/LIMIT WASHERS

1. Check surfaces of all limit washers. Washers scored or reduced in thickness should be replaced.

E. REVERSE IDLER GEAR ASSEMBLIES

1. Check bearing sleeves for wear from action of roller bearings.

F. GRAY IRON PARTS

1. Check all gray iron parts for cracks and breaks. Replace or repair parts found to be damaged. Heavy castings may be welded or brazed provided the cracks do not extend into bearing bores or bolting surfaces. When doing either A.C. or D.C. welding, however, never place the ground so as to allow current to pass through the transmission.

G. CLUTCH RELEASE PARTS

1. Check clutch release parts. Replace yokes worn at cam surfaces and bearing carrier worn at contact pads.
2. Check pedal shafts. Replace those worn at bearing surfaces.

H. SHIFT BAR HOUSING ASSEMBLY

1. Check for wear on shift yokes and blocks at pads and lever slot. Replace excessively worn parts.
2. Check yokes for correct alignment. Replace sprung yokes.
3. Check lockscrews in yokes and blocks. Tighten and re-wire those found loose.
4. If housing has been disassembled, check neutral notches of shift bars for wear from interlock balls. Bars indented at points adjacent to the neutral notch should be replaced.

L GEAR SHIFT LEVER HOUSING ASSEMBLY

1. Check spring tension on shift lever. Replace tension spring and washer if lever moves too freely.
2. If housing is disassembled, check pivot or spade pin and corresponding slot in lever for wear. Replace both parts if excessively worn.

J. BEARING COVERS

1. Check covers for wear from thrust of adjacent bearing. Replace covers damaged from thrust of bearing outer race.
2. Check bores of covers for wear. Replace those worn oversize.

K. OIL RETURN THREADS AND SEALS

1. Check oil return threads in front bearing cover. If sealing action of threads has been destroyed by contact with input shaft, replace bearing cover.
2. Check oil seal in mainshaft rear bearing cover. If sealing action of lip has been destroyed, replace seal.

L. SLIDING CLUTCHES

1. Check all shift yokes and yoke slots in sliding clutches for extreme wear or discoloration from heat.
2. Check engaging teeth of sliding clutches for partial engagement pattern.

M. FRONT BEARING COVER

1. Check inside hub of front bearing cover for wear caused by backing off of drive gear bearing nut.

N. O-RINGS

1. Check all O-rings for cracks or distortion. Replace if worn.

PRECAUTIONS

REASSEMBLY AND INSTALLATION

Since it is important that dirt and other foreign materials be kept out of the unit during reassembly, make sure the interiors of the case and housing are thoroughly cleaned before rebuilding begins. Dirt is an abrasive and can damage polished surfaces of bearings and washers.

Use the following precautions during reassembly and installation:

1. GASKETS — Use new gaskets throughout the transmission as it is being rebuilt. Make sure all gaskets are installed, as omission of any gasket can result in oil leakage or misalignment of bearing covers.

2. CAPSCREWS — TO prevent oil leakage, use thread sealant on all capscrews. For recommended torque ratings, see Torque Recommendations Section.

3. O-RINGS — Lubricate all O-rings with silicone lubricant.

4. ASSEMBLY — Refer to the illustrations provided in the Removal and Disassembly Section as a guide to reassembly.

5. INITIAL LUBRICATION — Coat all limit washers and splines of shafts with Lubriplate during reassembly to prevent scoring and galling of such parts.

6. AXIAL CLEARANCES — Maintain original axial clearances of .005" to .012" for mainshaft forward speed gears; .005" minimum for mainshaft reverse gear.

7. BEARINGS — Use of flange-end bearing drivers are recommended for the installation of bearings. See Tool Reference Section for specific tool recommendations. These special drivers apply equal force to both bearing races, preventing damage to balls and races while maintaining correct bearing alignment with bore and shaft.

8. UNIVERSAL JOINT COMPANION FLANGE OR YOKE — Pull the companion flange or yoke tightly into place with the mainshaft nut, using 450-500 foot-pounds of torque. Make sure the speedometer gear has been installed on yoke. If a speedometer gear is not used, a replacement spacer of the same width must be installed. Failure to pull the companion flange or yoke tightly into place will permit the output shaft to move axially with resultant damage to the rear bearing.

SHIFTING CONTROLS

I. GEAR SHIFT LEVER HOUSING ASSEMBLY

OLD STYLE

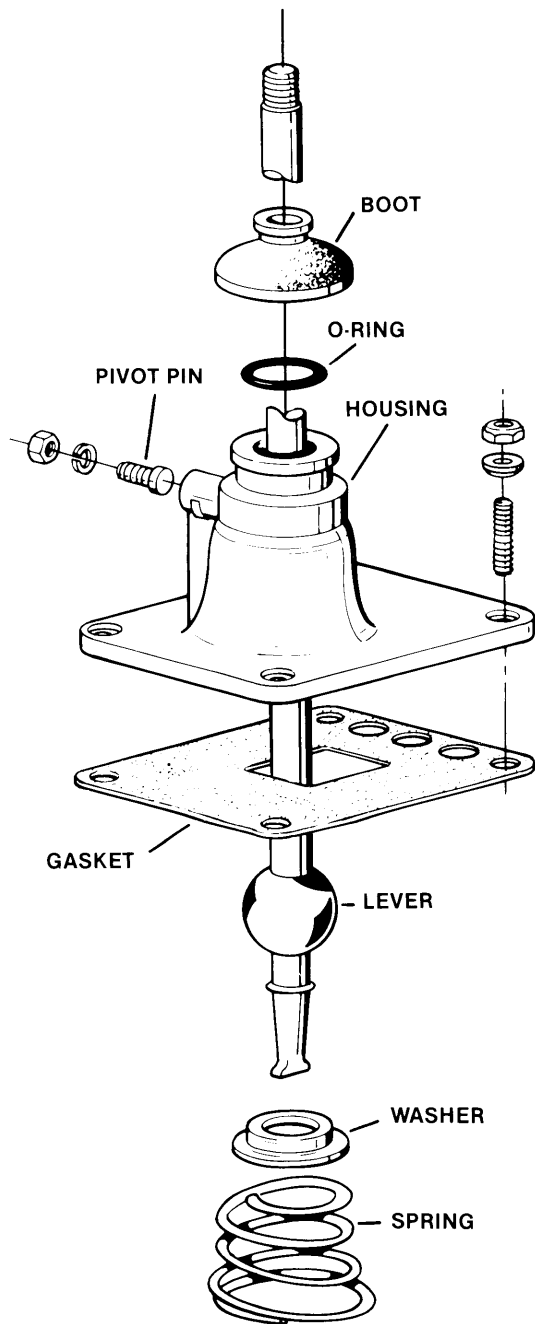

NEW STYLE

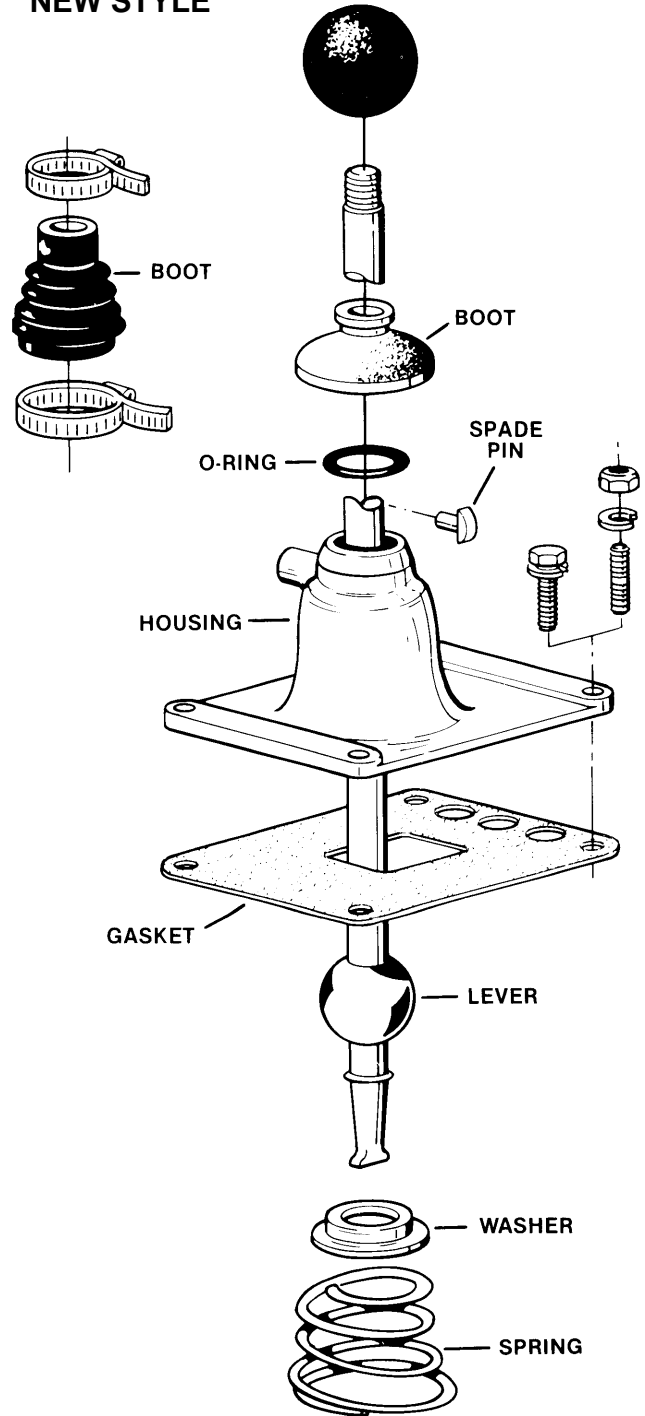

SHIFTING CONTROLS

A. Removal and Disassembly



1. Install the spade pin or pivot pin, nut and washer in the bore in the housing. If previously removed, install the O-ring in the groove.

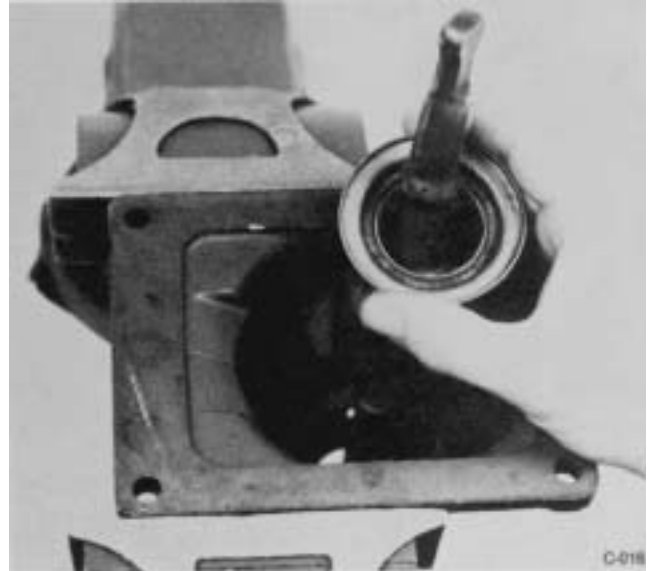

3. Remove the washer and gear shift lever from housing once the rubber boot and ball grip have been removed from lever.

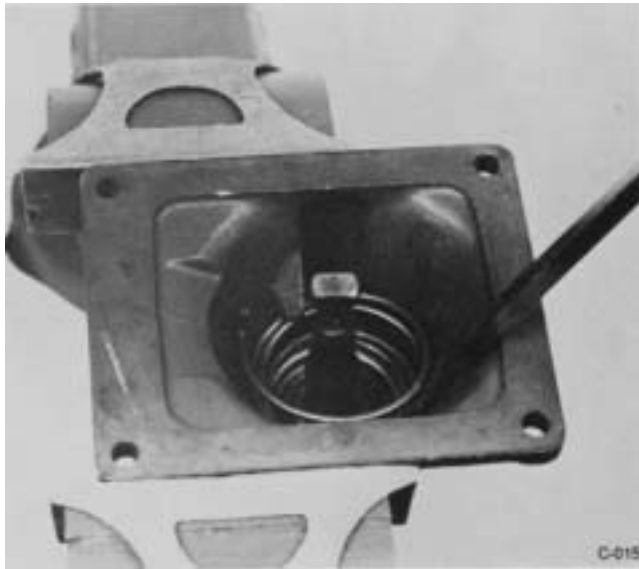

2. Secure the housing in a vise and use a large screwdriver to twist between the spring and side of the housing, forcing the spring from under the three lugs. Do one coil at a time. Remove the spring.

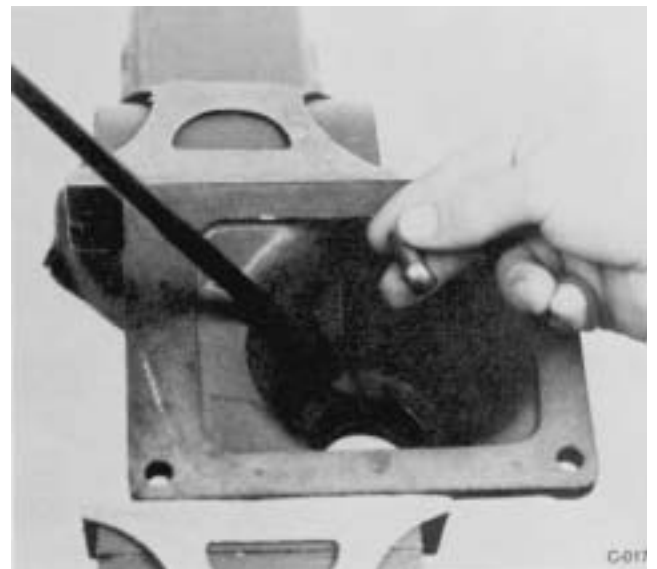

4. Remove the spade pin or pivot pin, nut and washer from the bore in the housing. If necessary, remove the O-ring from the housing.

SHIFTING CONTROLS

B. Reassembly



1. Install the spade pin or pivot pin, nut and washer in the bore in the housing. If previously removed, install the O-ring in the groove.



4. Remove assembly from vise and install the rubber boot over the gear shift lever and against neck of housing.



2. With the gear shift lever positioned in housing by spade or pivot pin in lever ball slot, install the tension spring washer over the lever ball with dished-side up.



5. Install ball grip on shift lever.

NOTE: For detailed installation instructions of gear shift lever housing assembly on shift bar housing assembly, see Reassembly and Installation Section, Part III-B, of this manual.



3. Seat the tension spring under the lugs in the housing, seating one coil at a time.

SHIFTING CONTROLS

II. SHIFT BAR HOUSING ASSEMBLY

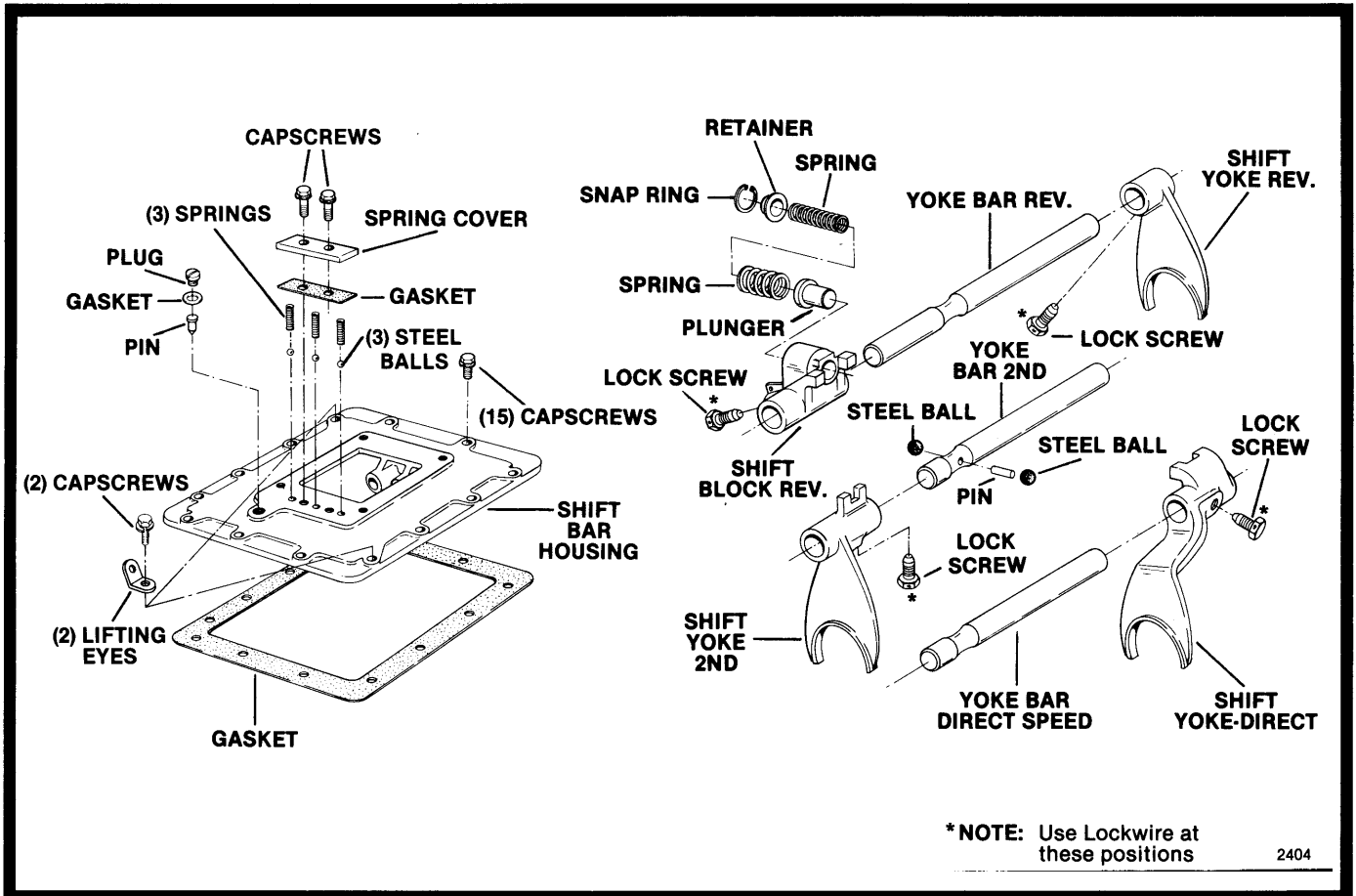

A. Removal and Disassembly



1. Turn out the attaching capscrews



2. Jar to break the gasket seal and lift the shift bar housing from transmission.

NOTE: During disassembly, lay all parts on a clean bench in the order in which they are removed to facilitate reassembly. Keep bars not being removed in the neutral position. Interlock parts will lock bars.

SHIFTING CONTROLS

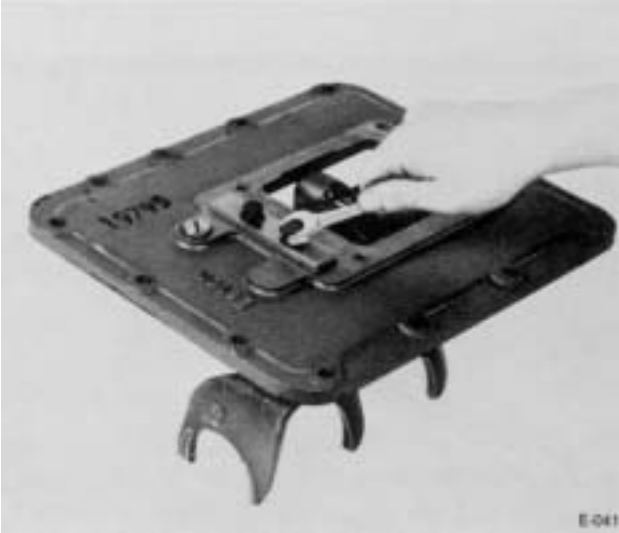

3. Turn out the two capscrews and remove the tension spring cover from top of housing.

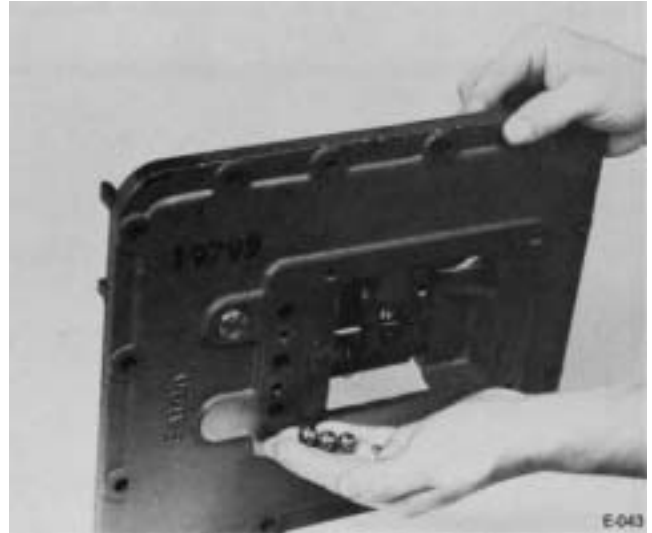

5. Tilt housing and remove the tension balls installed under springs.



4. Remove the three tension springs from bores in housing and the gasket for tension spring cover.

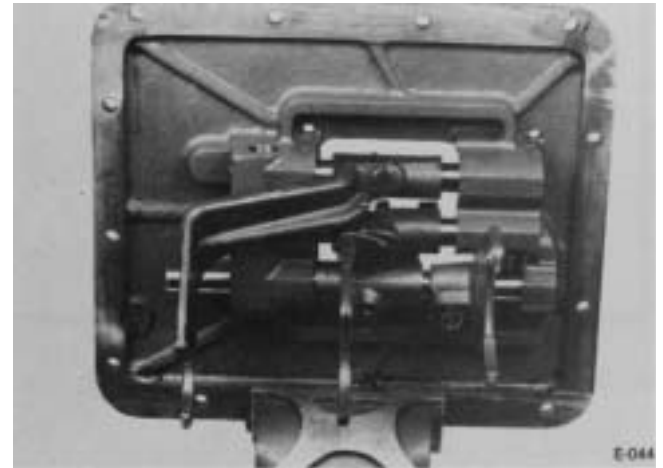

6. Place the housing in a vise with the left side up; the long 1st-reverse speed shift bar will be at the bottom.
7. Cut lockwire and remove lockscrews from each bar just prior to its removal.

SHIFTING CONTROLS

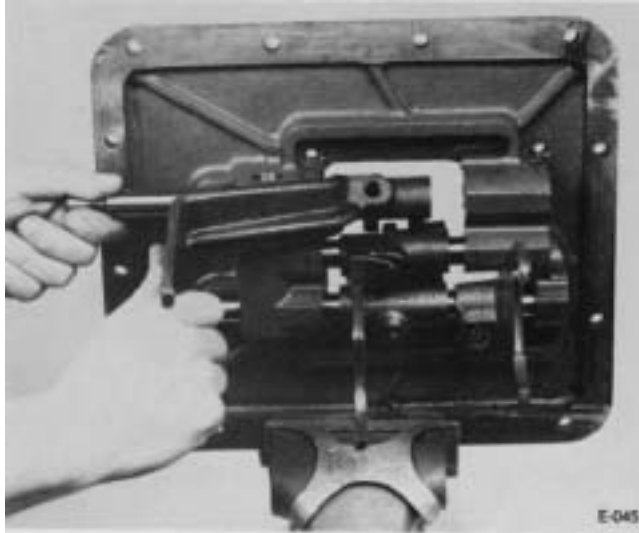

8. Move the top, 4th-5th speed shift bar to the front and out of housing, removing shift yoke from bar.



10. Move the bottom, 1st-reverse speed shift bar to the front and out of housing, removing the shift yoke and block from bar.

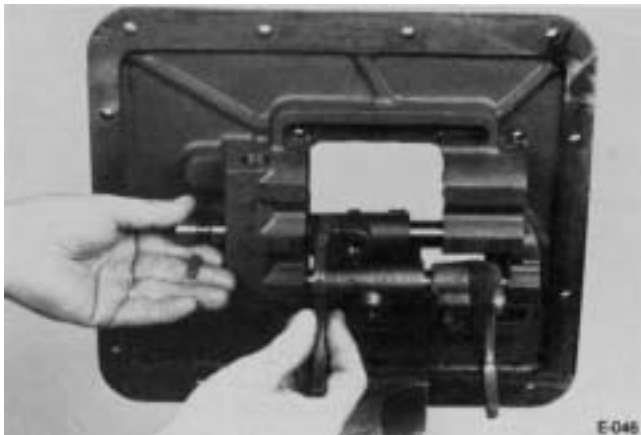

9. Move the 2nd-3rd speed shift bar to the front and out of housing, removing the shift yoke from bar. As the neutral notch in bar clears housing boss, remove the small interlock pin from bore in neutral notch.

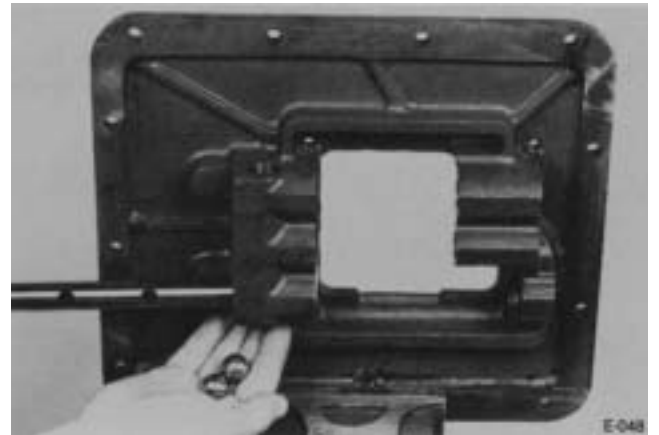

11. Two interlock balls will fall from interlock bail opening in front boss as the last bar is removed.

SHIFTING CONTROLS

B. Reassembly

1. Install the housing in a vise with the left side up.

NOTE: Shift bars should be installed from the front with neutral and shift notches to the front. Keep bars in the neutral position when installed.



2. Install the 1st-reverse shift bar in bottom bore in housing, installing the shift yoke and block on bar, long hub of each to the front.

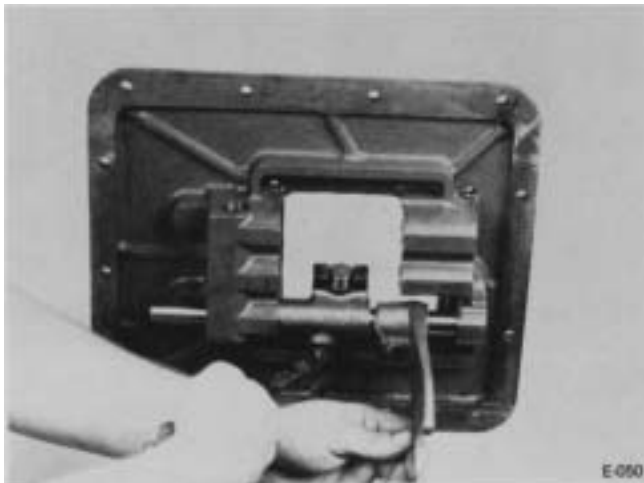

3. Install lock screw in yoke and block, tighten and lock wire securely.

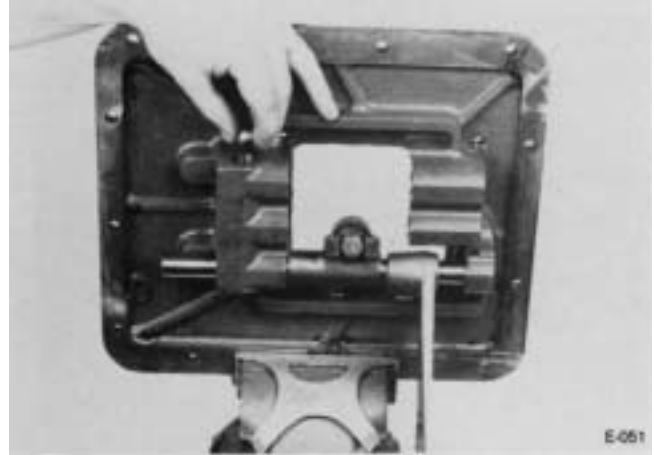

4. Install 3/4" interlock ball in bore in front boss.

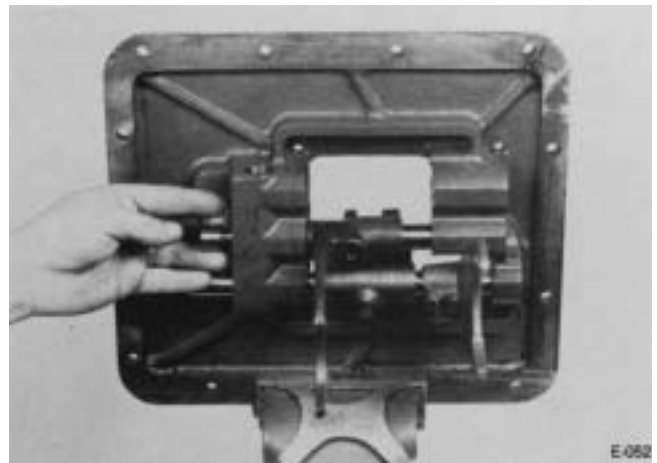

5. Install the 2nd-3rd speed shift bar in center bore in housing and install shift yoke, long hub to the rear. At the same time install interlock pin in bore in neutral notch of bar as notch enters front boss.

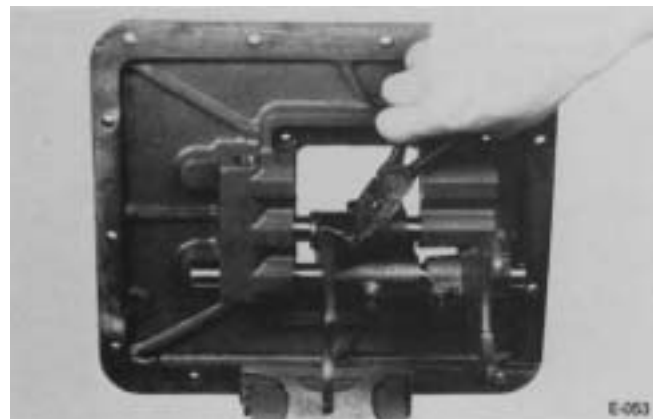

SHIFTING CONTROLS

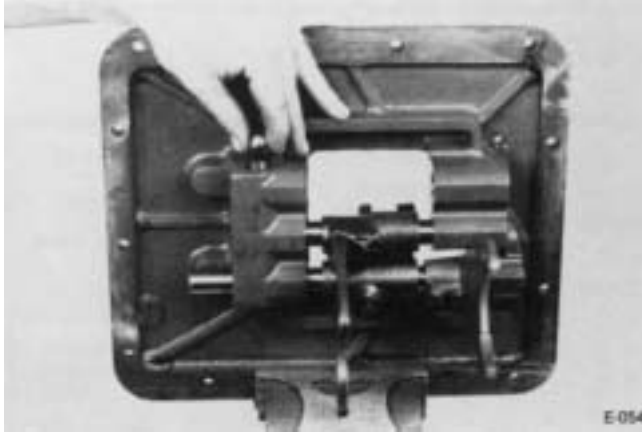

7. Install 3/4" interlock ball in bore in front boss.



10. Remove housing from vise and install the three shift bar tension balls in bores in top of housing.



8. Install the 4th-5th speed shift bar in upper bore in housing installing shift yoke on bar, fork to the front.

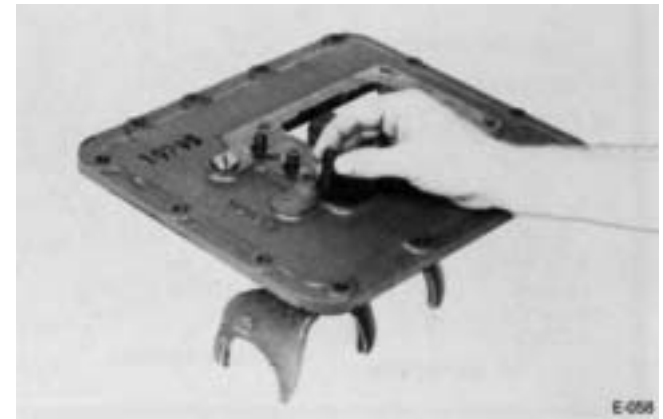

11. Install three tension springs in bores.

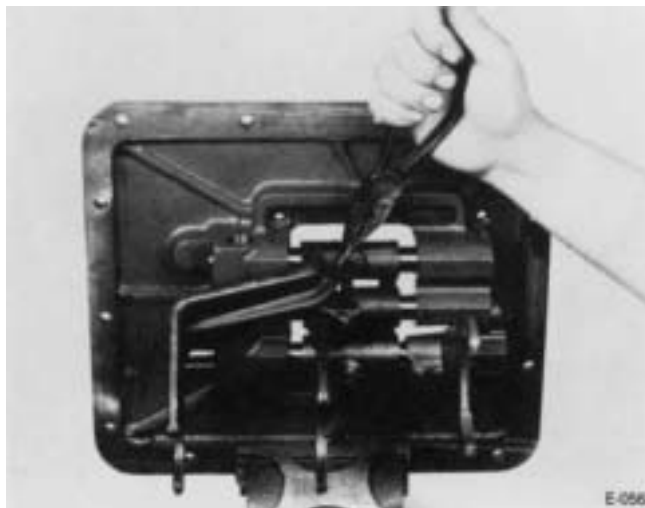

9. Install yoke lock screw, tighten and lock with lockwire.



12. Place a new tension spring cover gasket into position on shift bar housing and install cover. Tighten capscrews to secure.

NOTE: For detailed installation instructions of shift bar housing assembly on case, see Re-assembly and Installation Section, Part III-A, of 966 West Gore St, Orlando, FL, 32805 | +1 (877)-776-4600 | +1 (407)-872-1191 | parts@eprogear.com

REMOVAL AND DISASSEMBLY

III. COMPANION FLANGE OR YOKE, REAR BEARING COVER ASSEMBLY, AND CLUTCH HOUSING

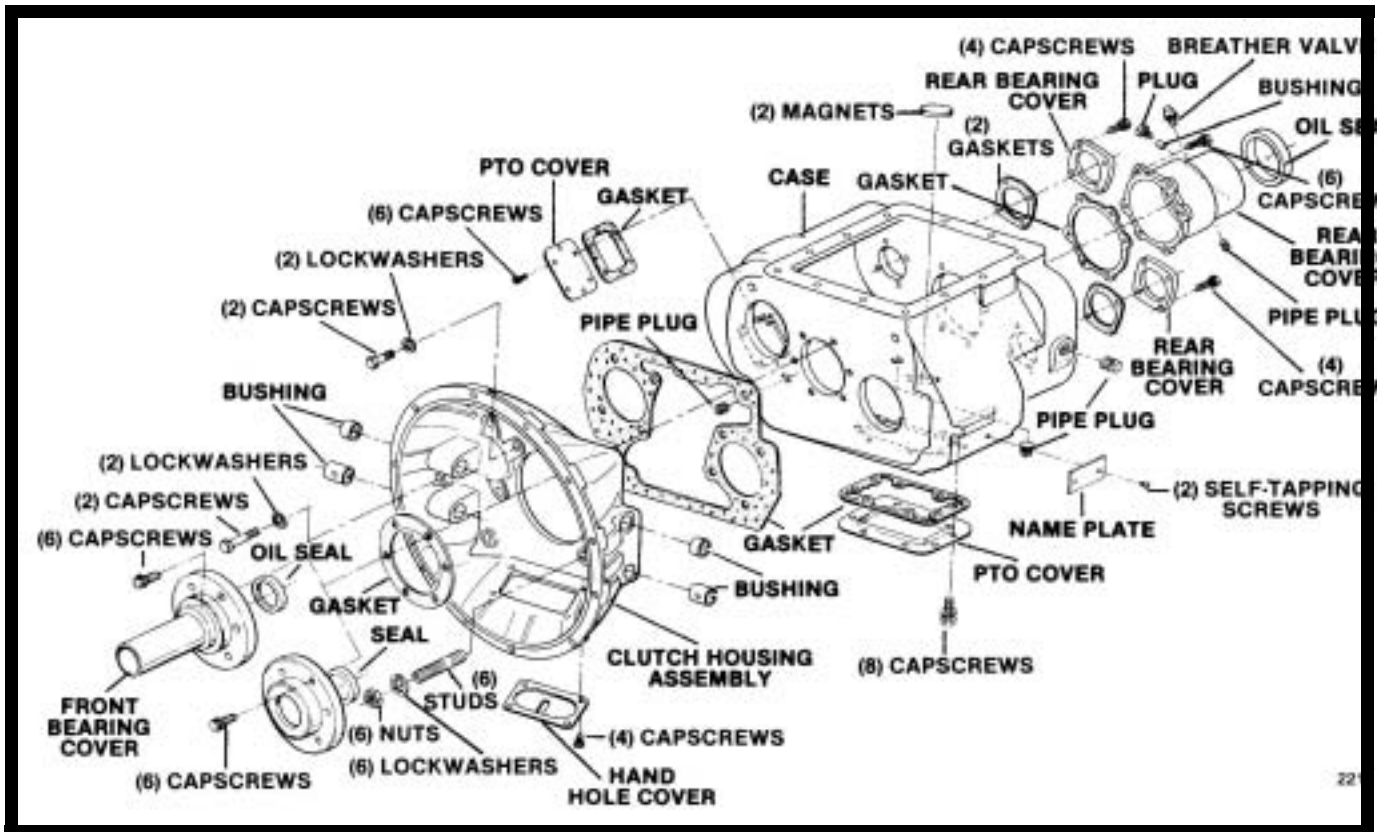

A. Removal of Companion Flange or Yoke



1. Lock the mainshaft by engaging two mainshaft sliding clutches and turn the elastic stop nut from the output shaft.
2. Pull flange or yoke from splines of the output shaft.

REMOVAL AND DISASSEMBLY

B. Removal and Disassembly of Rear Bearing Cover Assembly



1. Turn out the attaching capscrews from the rear bearing cover.



2. Pry the bearing cover evenly to the rear to unseat from output shaft bearing.



3. Remove the bearing cover and gasket from output shaft.



4. Remove oil seal from cover if necessary.

REMOVAL AND DISASSEMBLY

C. Removal of Clutch Housing

NOTE: For models otherwise equipped with Amid-ship Assembly, refer to illustration provided in Options Section of this manual.

1. Remove the clutch release mechanism if the transmission is so equipped.

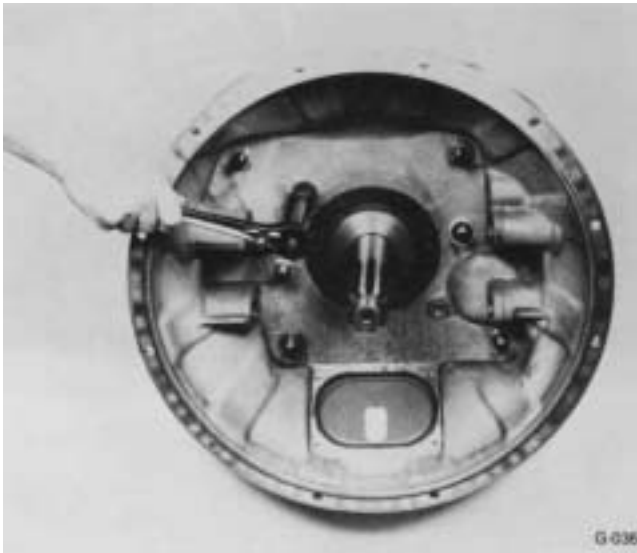

2. Turn out the four capscrews and remove the six nuts and lockwashers from studs at front of case.



3. Break gasket seal and pull clutch housing from case.

REMOVAL AND DISASSEMBLY

IV. CASE-INNER ASSEMBLIES

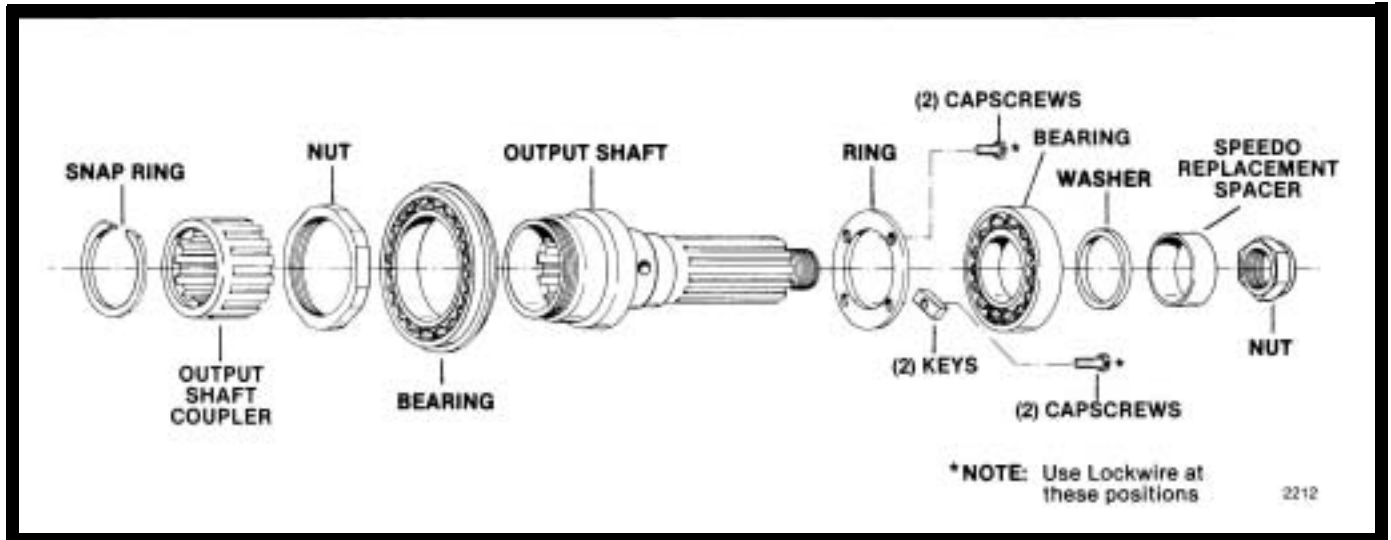

A. Removal and Disassembly of Output Shaft Assembly



1. Remove the speedometer gear, or replacement spacer, and the bearing washer from output shaft or from cover.



3. Cut lockwire and turn out the two 5/16-24 x 1" cap screws from the two flat retainers or keys.

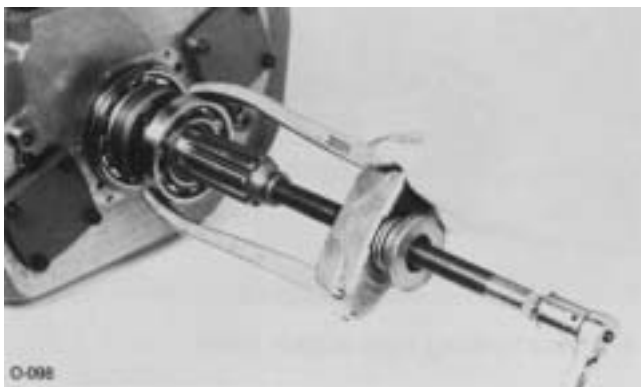

2. Pull the outer bearing from output shaft. (This bearing is on the cover. In this case, move the bearing evenly forward and from cover.)



4. Remove the two flat retainers from bores in output shaft. When the flat retainers are removed, the output shaft will remain in position in relation to output shaft.

REMOVAL AND DISASSEMBLY



5. Remove output shaft from case bore. Start assembly to the rear with screwdriver, prying evenly against bearing snap ring.



8. Place output shaft in vise and remove the bearing nut, left-hand thread.

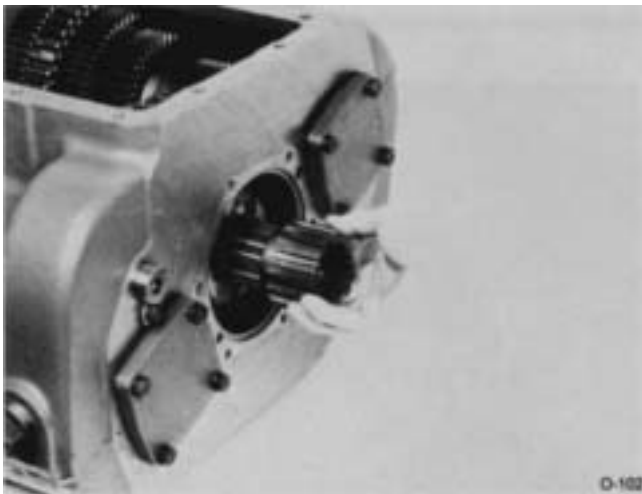

6. Remove the splined coupler from mains haft, or from pocket in output shaft.

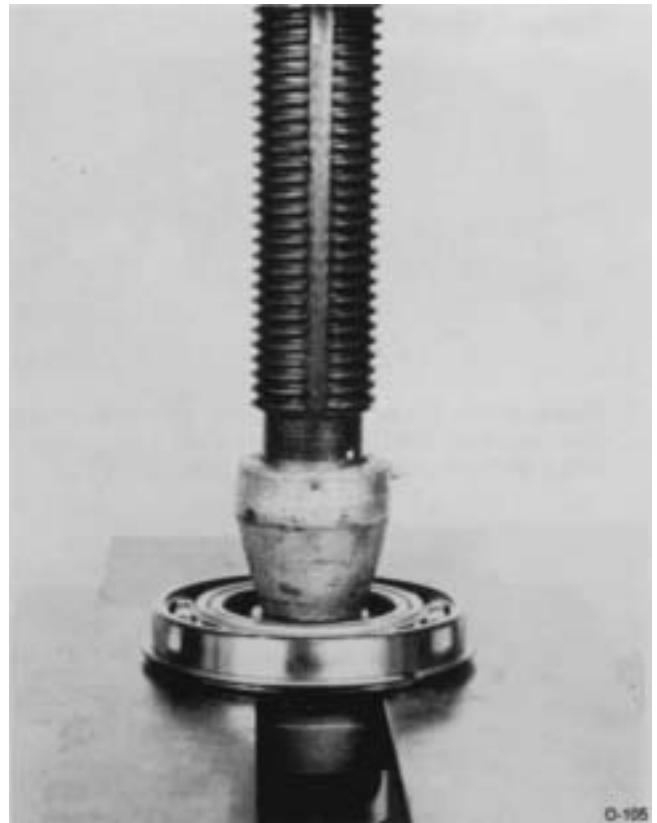

9. Press bearing from output shaft.



7. Turn out the two 3/16-24 x 3/8 cap screws and remove the easy spacer from output shaft.

REMOVAL AND DISASSEMBLY

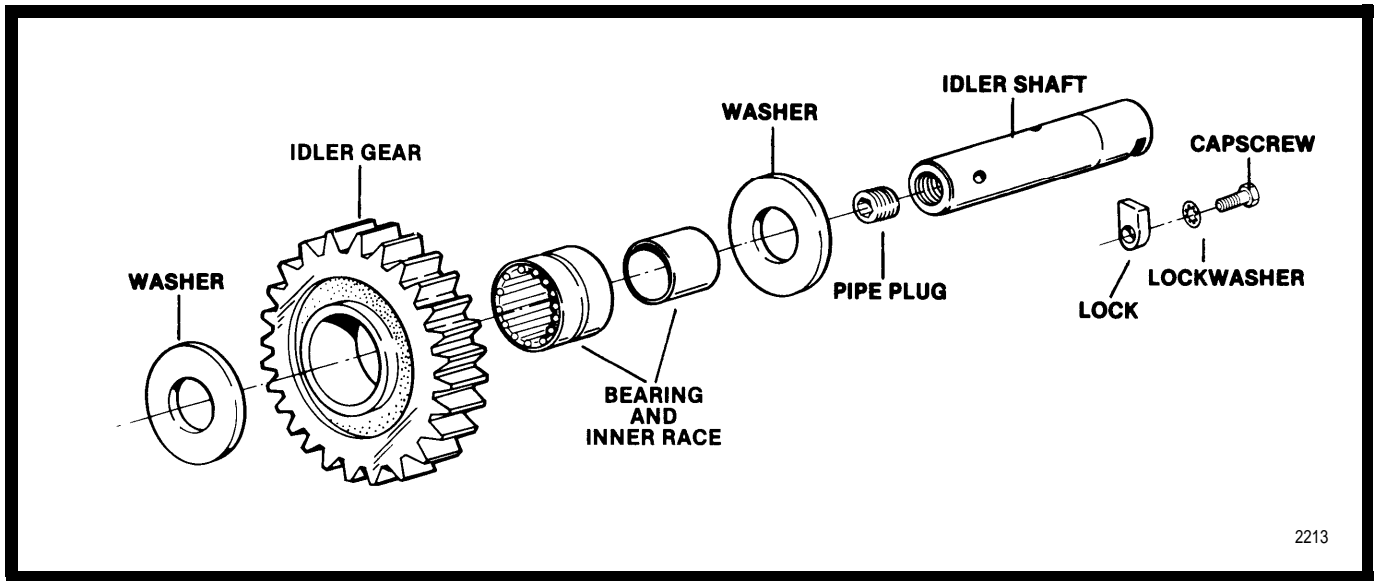

2213

B. Removal and Disassembly of Left Reverse Idler Gear Assembly

NOTE: The left reverse idler gear must be removed in order to remove the mainshaft assembly.

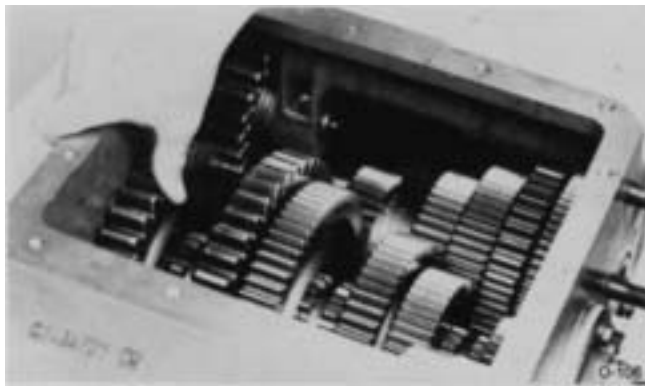

1. Move the mainshaft assembly forward as far as possible and the mainshaft reverse gear to the rear against case.



3. Engage reverse gear with the 1st-reverse sliding clutch and move the reverse gear forward against the 1st speed gear.



2. Remove Gear and Transmission. Do not remove gear and transmission. Cut cap screw at rear of transmission and reverse gear. Remove the lock plate from slot in the idler shaft.

REMOVAL AND DISASSEMBLY



5. Use impact puller to withdraw the idler shaft from case.



7. If necessary, remove the inner race from idler gear needle bearing, the needle bearing from idler gear, and the pipe plug from idler shaft.

C. Removal of Countershaft Bearings

NOTE: *Although the bearings of both countershafts are removed in the same manner, it is necessary to remove the bearings from only the right countershaft to remove the mainshaft assembly from case.*



6. Remove the reverse idler gear and the two thrust washers from case.

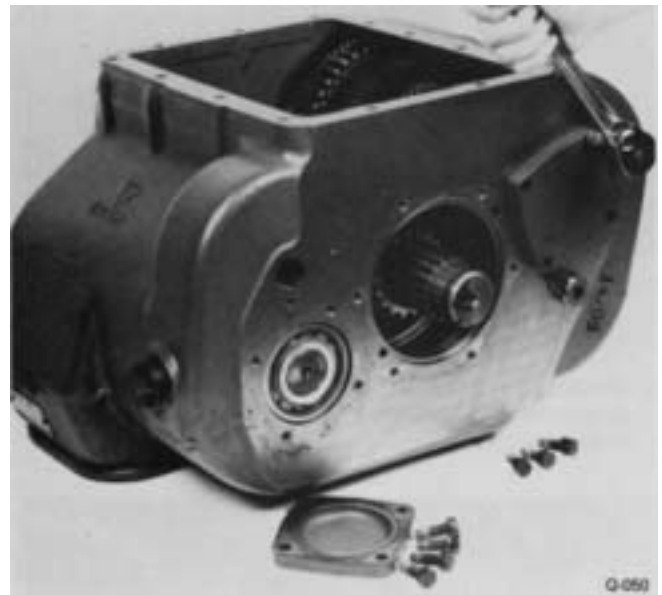

1. Turn out capscrews and remove the rear bearing cover and gasket from each countershaft.

REMOVAL AND DISASSEMBLY

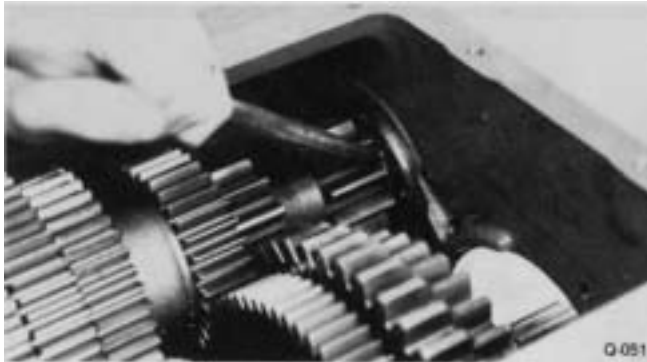

2. Use a soft punch and maul from inside case to drive the rear countershaft bearings to the rear and from case bores. (NOTE: This removal procedure will damage the bearings and should not be attempted unless replacement of the bearings is planned.)

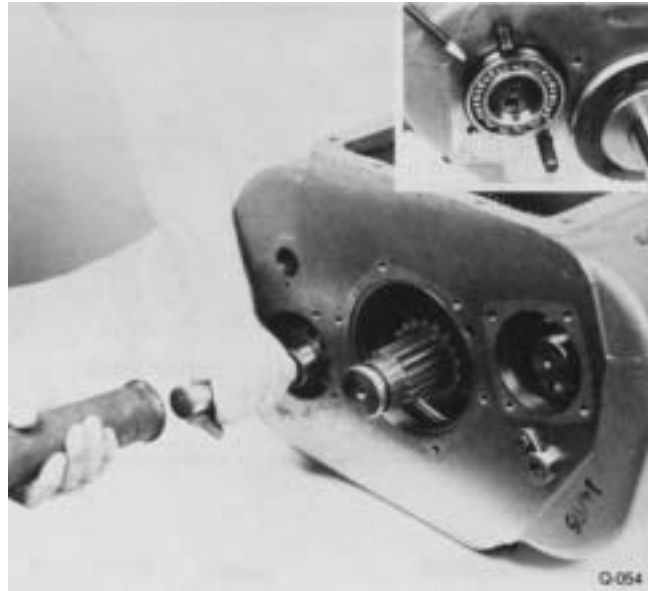

5. With the same soft bar and maul on the rear of each countershaft, drive the countershafts forward to expose the front bearing snap rings.



3. Cut lockwire and remove the two cap screws and retainer plate from the front of each countershaft. For models so equipped with bearing retaining snap rings in groove of countershafts, remove snap ring from groove in both countershafts.

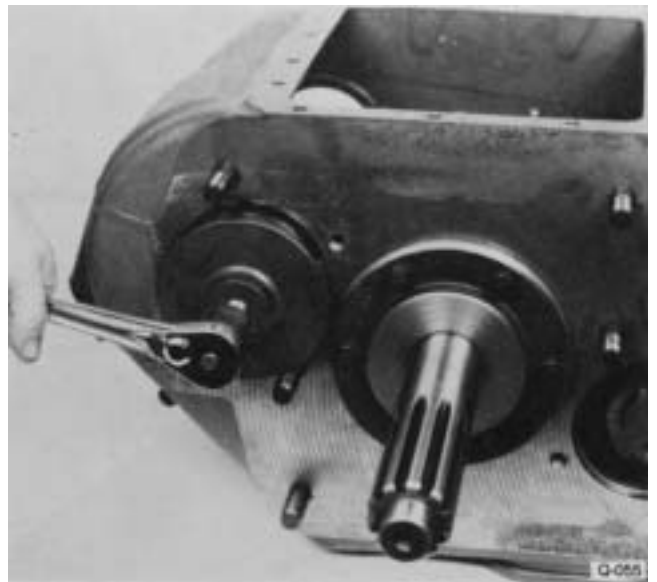

6. Use a bearing puller to remove the front bearing from each countershaft.



4. Use a bearing puller to remove the front bearing from each countershaft to the rear, approximately 3/8".

REMOVAL AND DISASSEMBLY

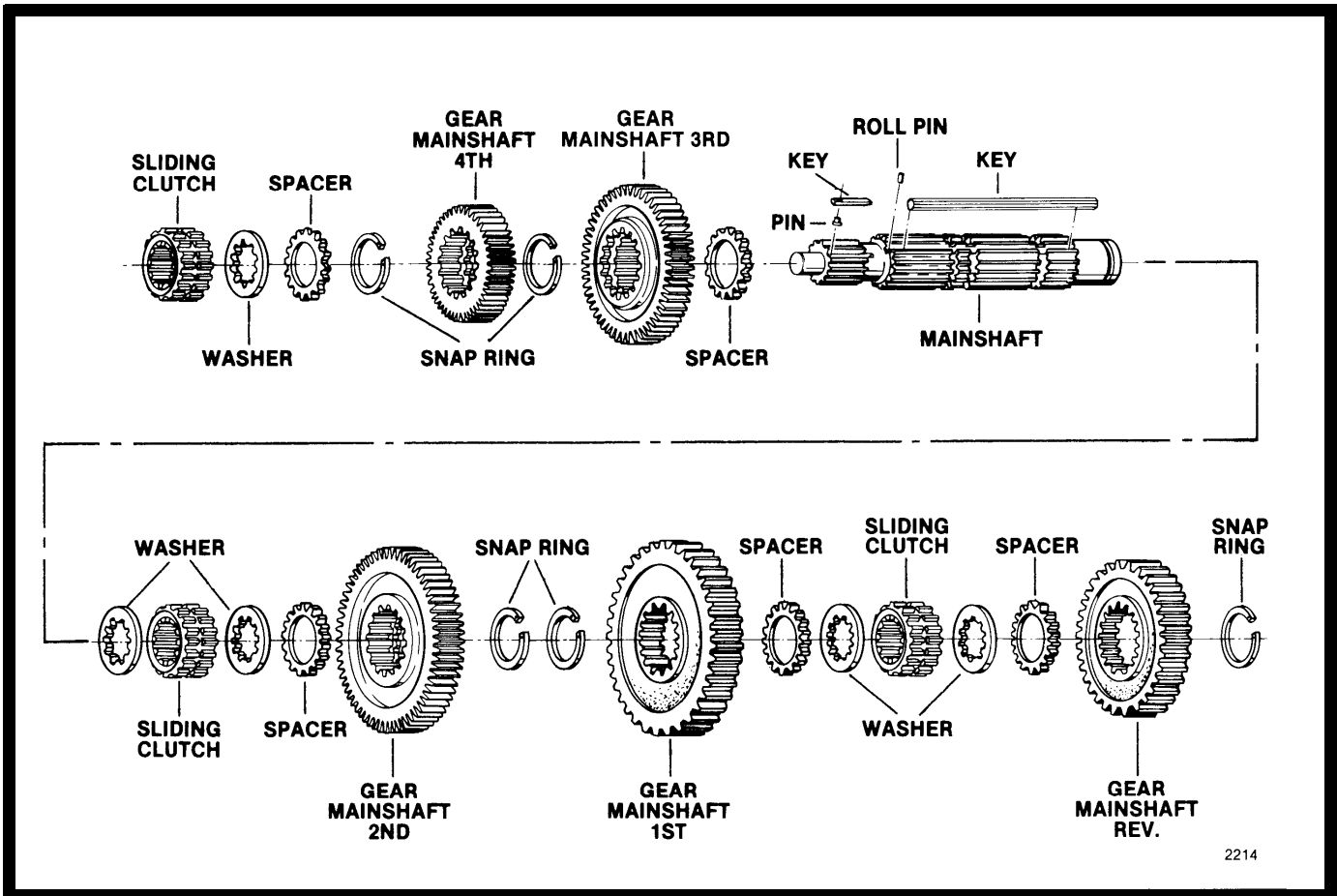

2214

D. Removal and Disassembly of Mainshaft Assembly

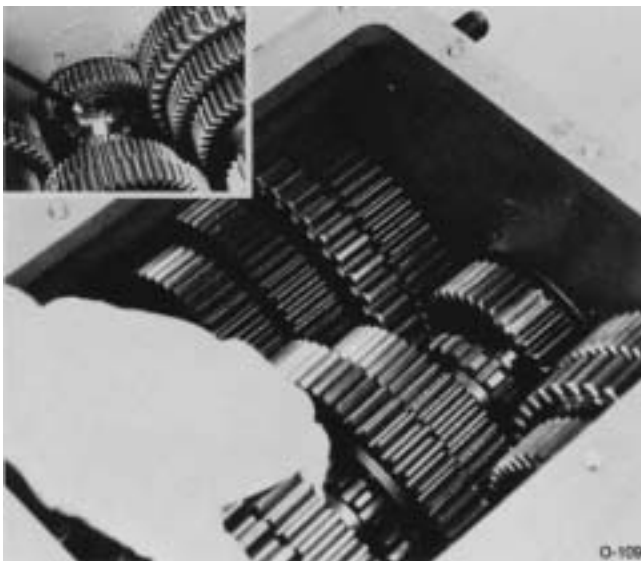

1. With the right countershaft moved toward wall of case, pull the mainshaft to the rear to free pilot from pocket of input shaft.



2. Holding 3rd and 4th speed gears, tilt the front of the mainshaft up and lift assembly from case. Use caution as the reverse gear is free and can fall off the shaft.

NOTE: When removing limit washers, spacers and gears, note their location to facilitate reassembly. Keep limit washers and spacers with the gear from which they were removed. There should be only one spacer and one limit washer for each gear in the mainshaft assembly.

REMOVAL AND DISASSEMBLY

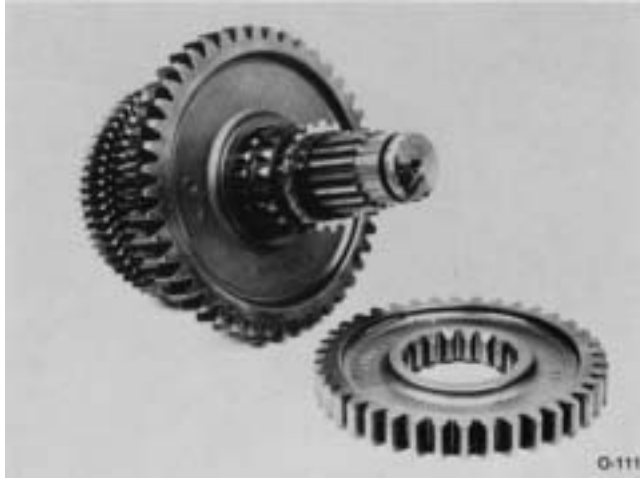

3. Remove the reverse gear from rear of mainshaft.

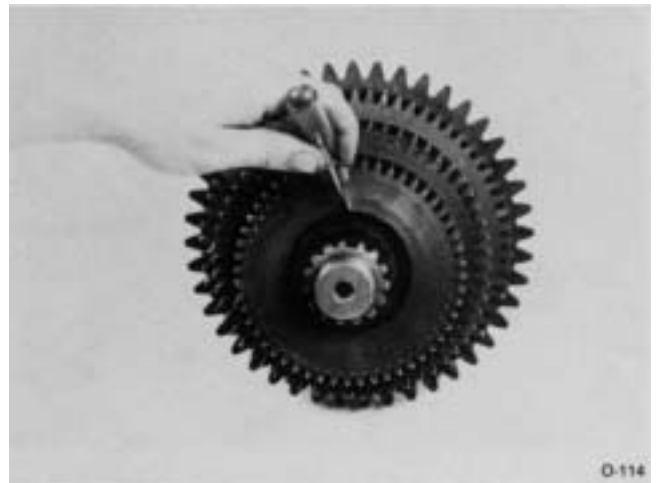

6. With a small screwdriver, rotate the 4th speed gear limit washer, recessed within the gear hub, to align its splines with those of the mainshaft.

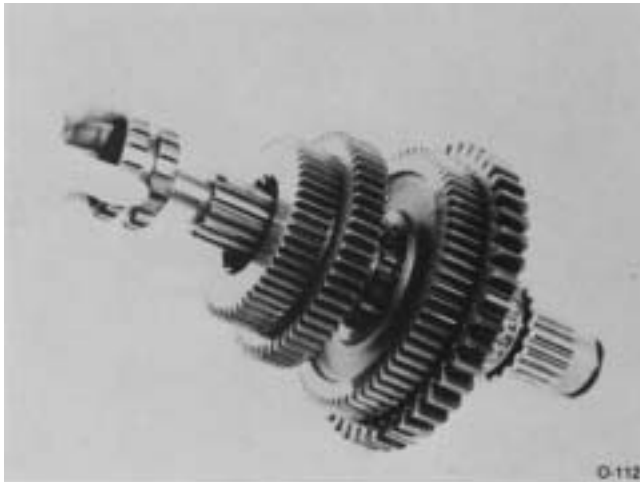

4. Remove the 4th-5th speed sliding clutch from front of mainshaft.

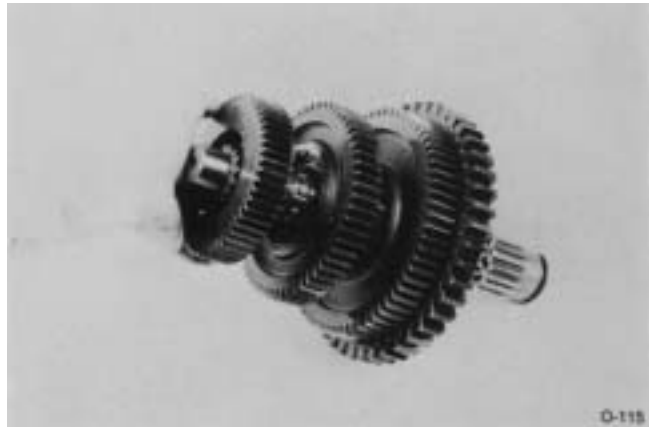

7. Pull the 4th speed gear from front of mainshaft to remove limit washer, spacer, and gear.

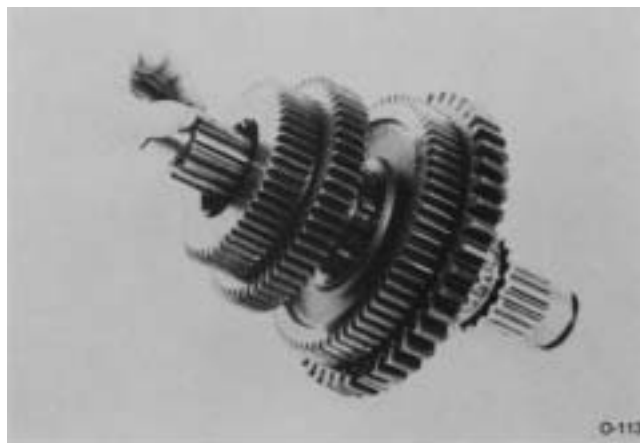

5. Remove the short key from keyway near front of mainshaft. This key locks the 4th speed gear.



8. Remove the 3rd speed gear and spacer from front of mainshaft. The 3rd speed gear limit washer cannot be removed at this time as it is

REMOVAL AND DISASSEMBLY

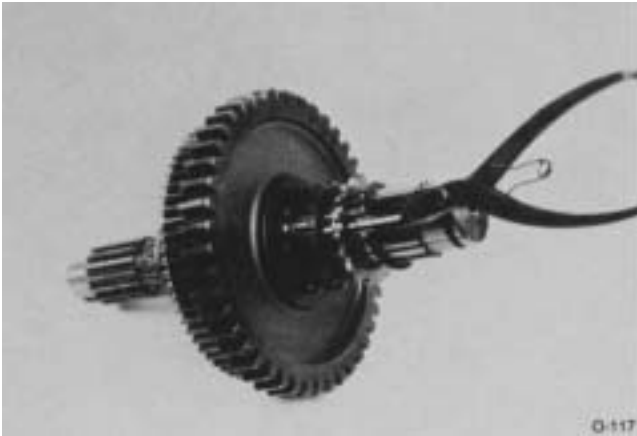

9. Remove the long key retaining snap ring from slot near rear of mainshaft.

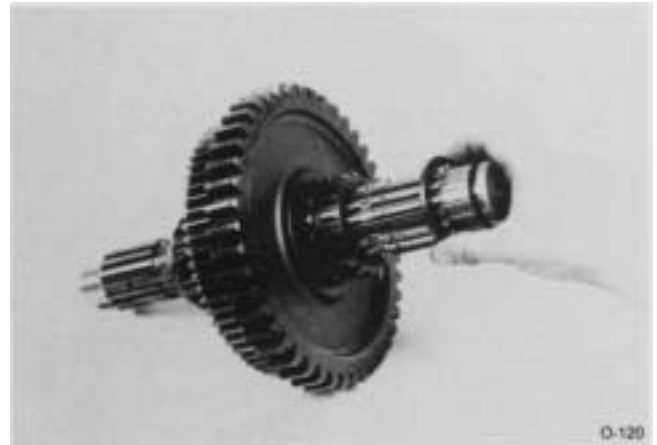

12. Rotate reverse gear limit washer to align its splines with those of the mainshaft and remove washer.

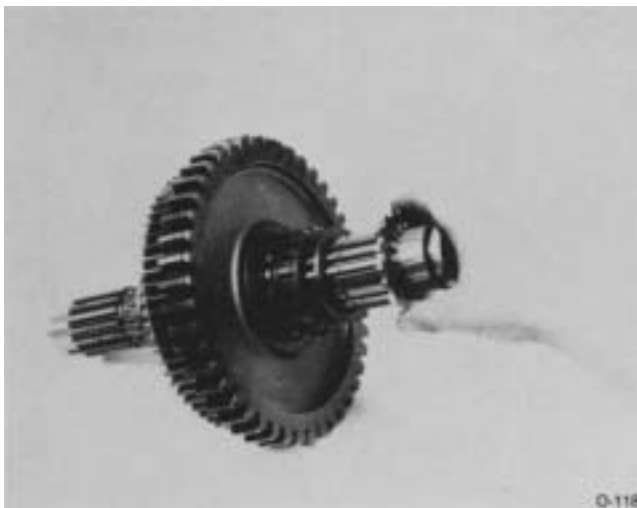

10. Remove the reverse gear spacer.

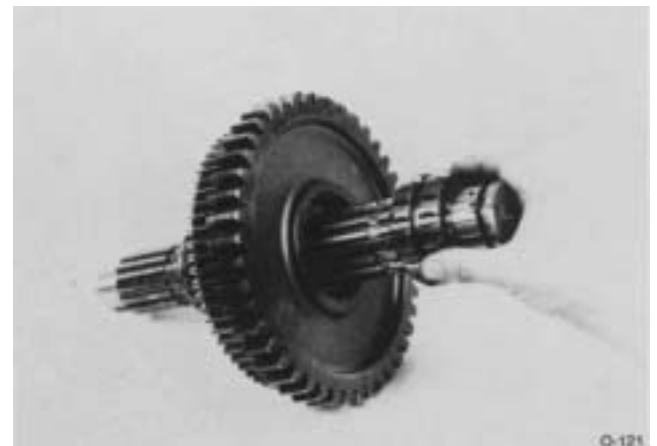

13. Remove 1st-reverse sliding clutch from mainshaft.

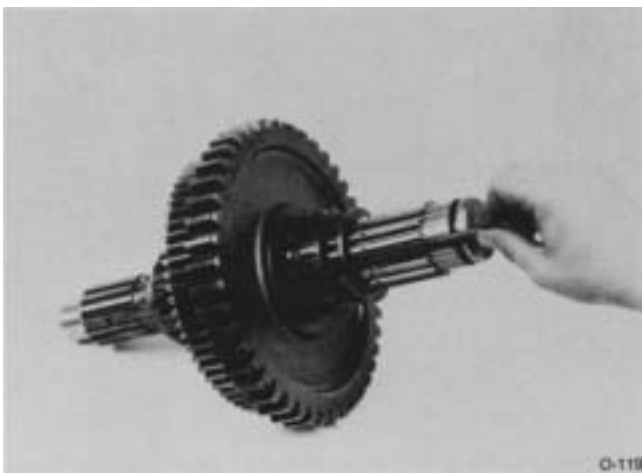

11. From rear of mainshaft, pull the long key from mainshaft.

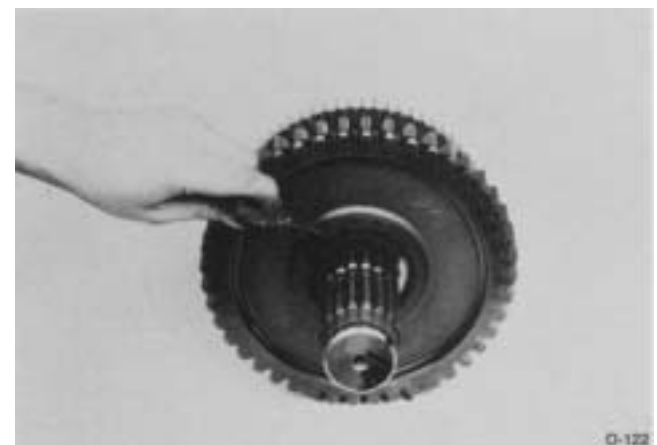

14. With a small screwdriver, rotate the 1st speed gear limit washer to align its splines with those of the mainshaft.

REMOVAL AND DISASSEMBLY



15. Pull the 1st speed gear from rear of mainshaft to remove limit washer, spacer, and gear.



18. Remove the 2nd-3rd speed sliding clutch from mainshaft.

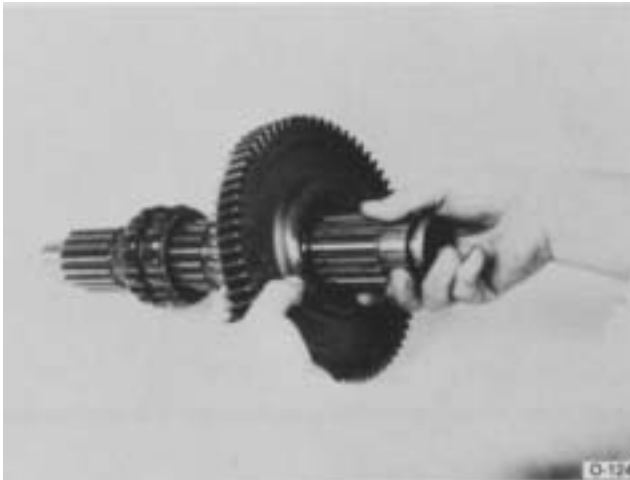

16. Remove 2nd speed gear and spacer from mainshaft.

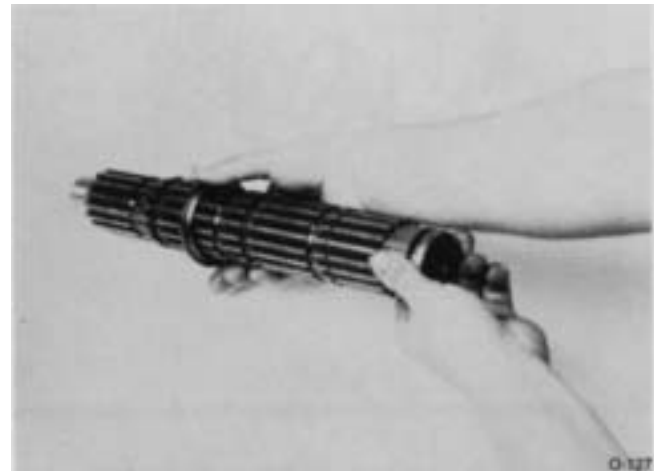

19. Rotate 3rd speed gear limit washer to align its splines with those of mainshaft and remove washer.

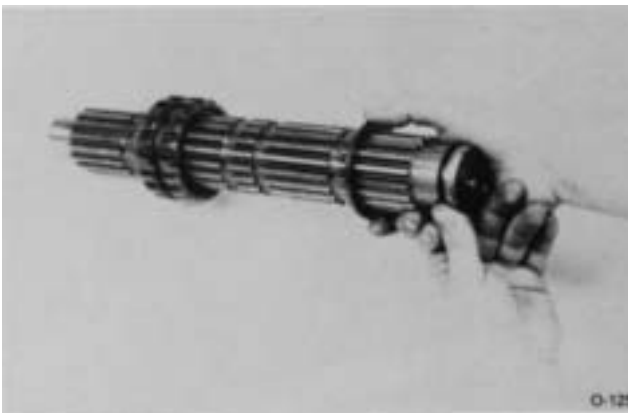

17. Rotate 2nd speed gear limit washer to align its splines with those of the mainshaft and remove washer.

REMOVAL AND DISASSEMBLY

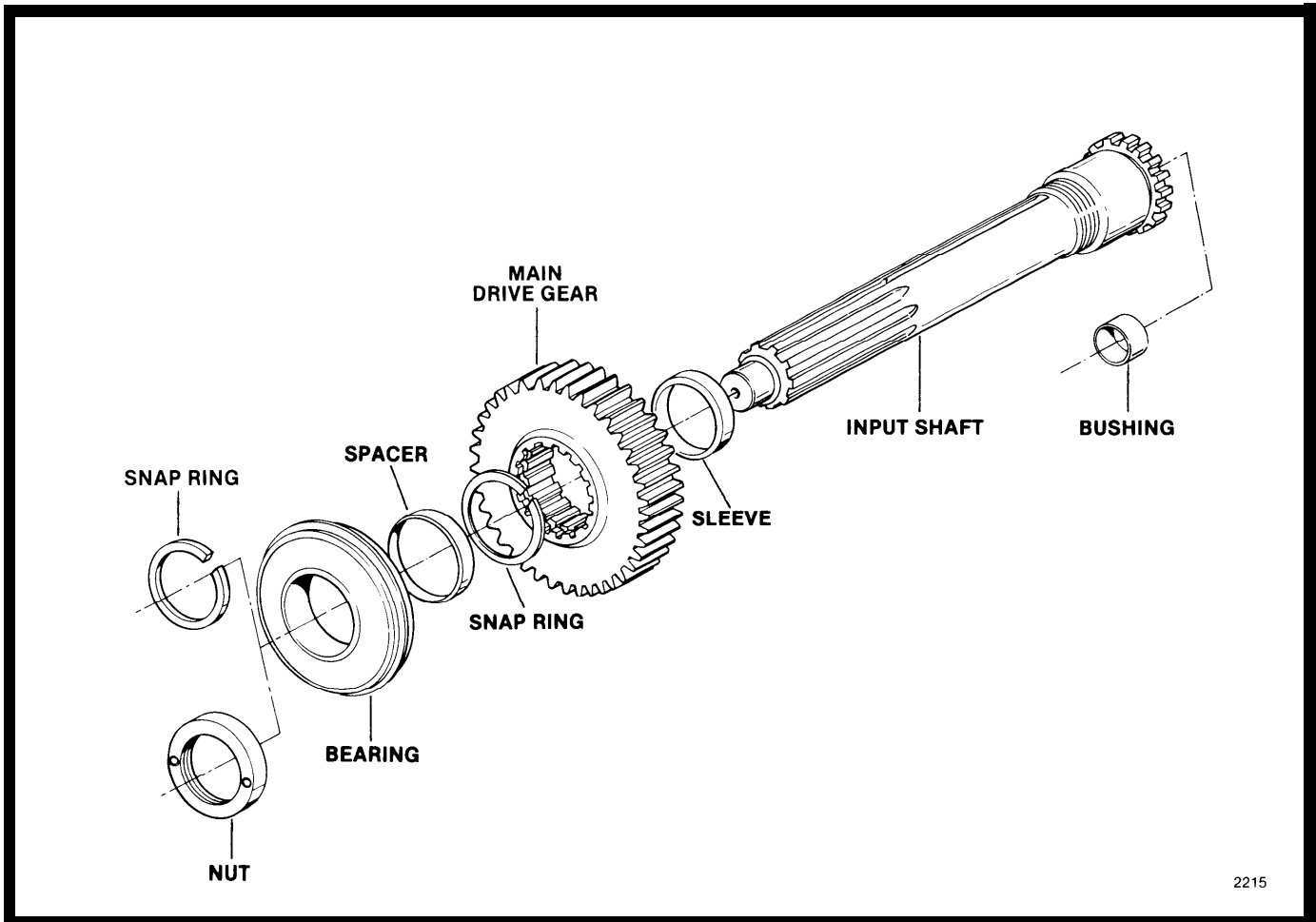

2215

E. Removal and Disassemble of Main Drive Gear Assembly

NOTE: For models equipped with an Amidship Assembly in place of a Drive Gear Assembly, refer to Options Section of this manual.



1. Remove Nut from Input Shaft. **2.** Use a soft bar and maul from inside case to move Main Drive Gear Assembly from gear case bore towards front bearing as far as possible to expose front bearing snap ring from case bore.

REMOVAL AND DISASSEMBLY

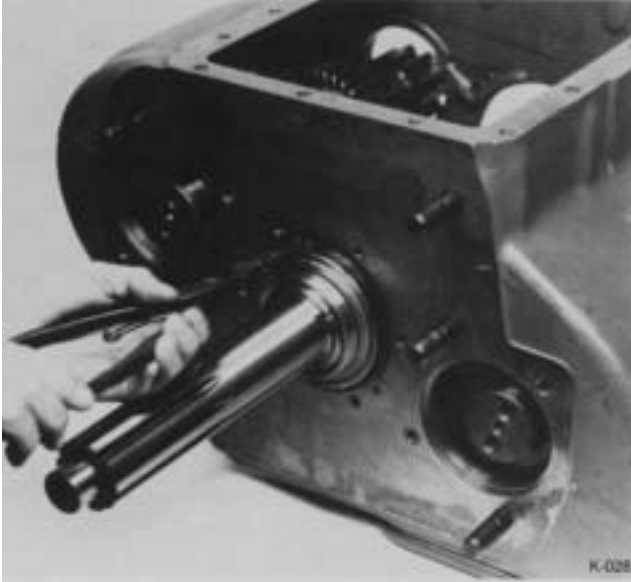

3. Remove snap ring from front bearing.

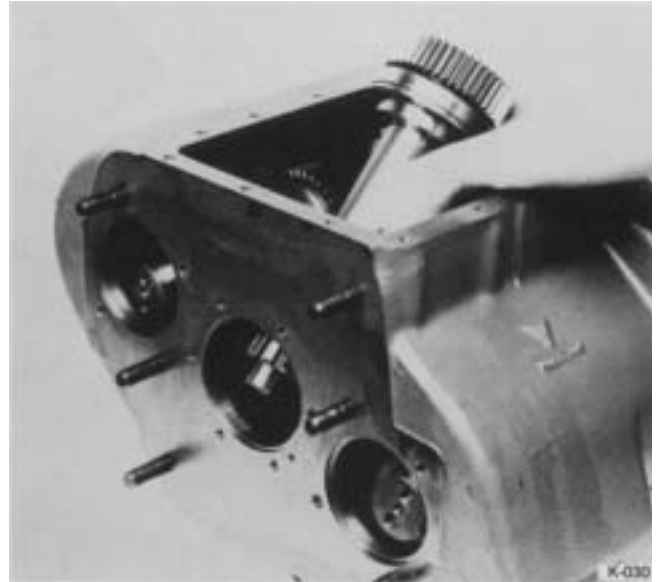

5. Remove drive gear assembly from transmission by lifting it out through top of case.

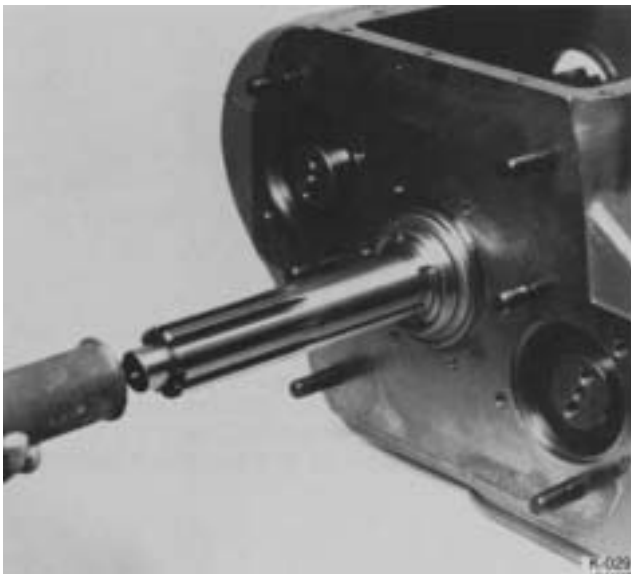

4. Use a soft maul, rubber or rawhide mallet to move input shaft into case, being careful as not to damage pilot-end.

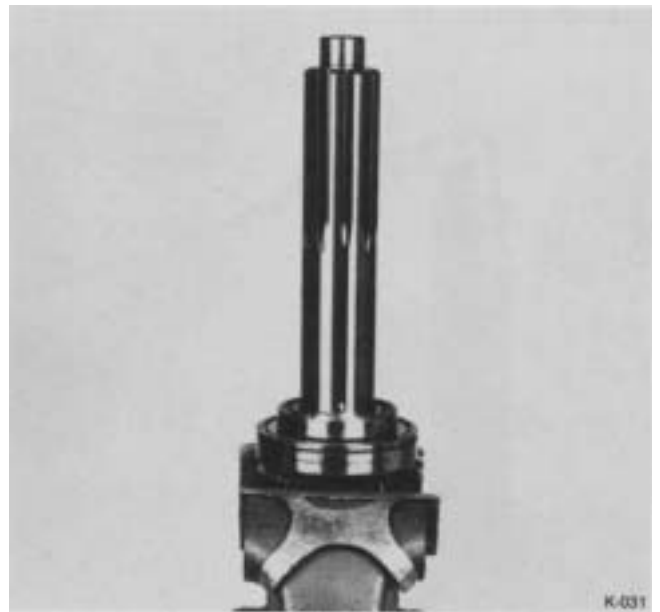

6. Secure assembly in a vise, pilot end up, on drive gear O. D. The vise used should be equipped with either brass jaws or wood blocks to prevent damage to the teeth of drive gear.

REMOVAL AND DISASSEMBLY



7. Use a punch and maul to relieve bearing nut from shaft, left hand thread.



9. Remove assembly from vise to press input shaft through bearing and gear. If necessary, remove snap ring from drive gear I.D. Check the bushing in pocket of input shaft and replace if damaged or worn.



8. Use a drive gear bearing nut remover to turn the bearing nut from shaft, left hand thread.

REMOVAL AND DISASSEMBLY

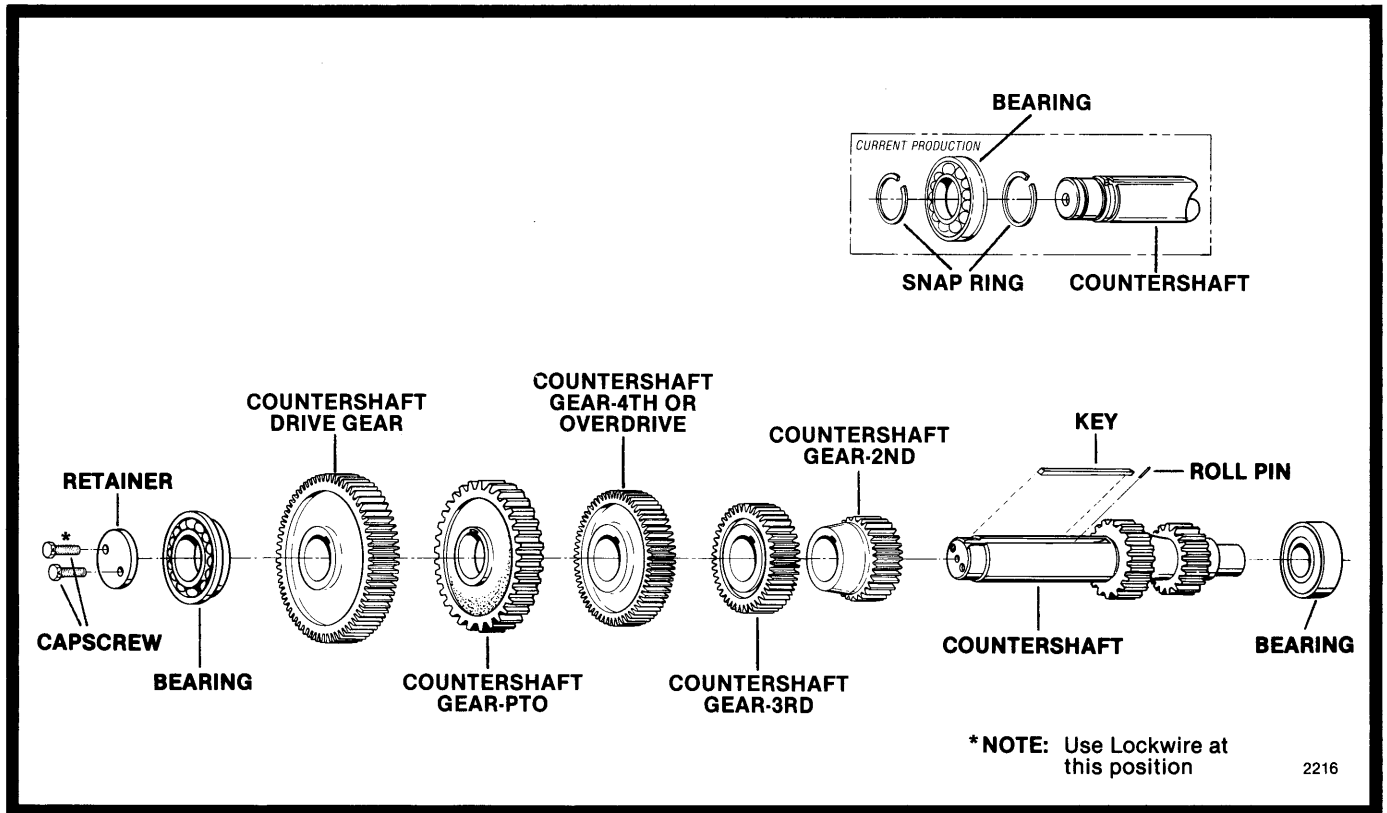

F. Removal and Disassembly of Countershaft Assemblies

1. If not previously done so, remove front and rear bearings of left countershaft as described in Part C of this section.



2. Move either countershaft assembly to the rear, lift front of shaft to the center of case by the drive and PTO gears and remove through top of case. Repeat same process for other countershaft assembly.

NOTE: Except for the PTO gears, the left and right countershaft assemblies are identical. Disassembly of both shafts and bearings in the same gear

3. For models so equipped with a countershaft gear retaining snap ring in groove nearest to drive gear, remove snap ring from countershaft.

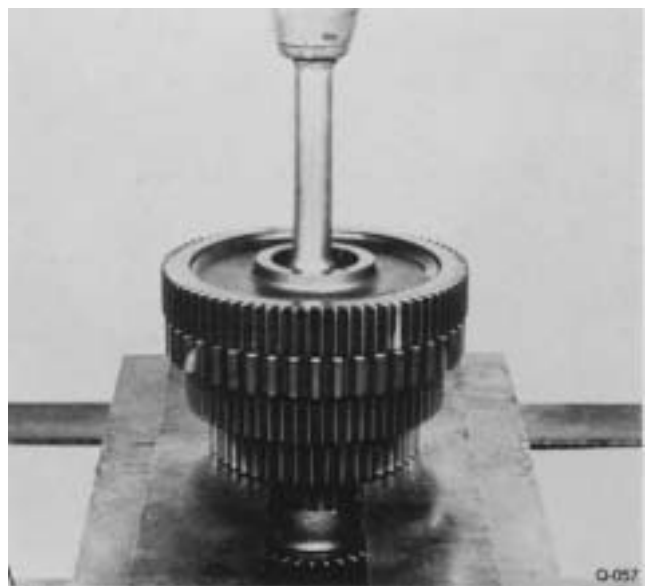

4. Press the drive gear, PTO gear, 4th speed gear, and 3rd speed gear from countershaft. Use caution when pressing gears as it is necessary to

REMOVAL AND DISASSEMBLY

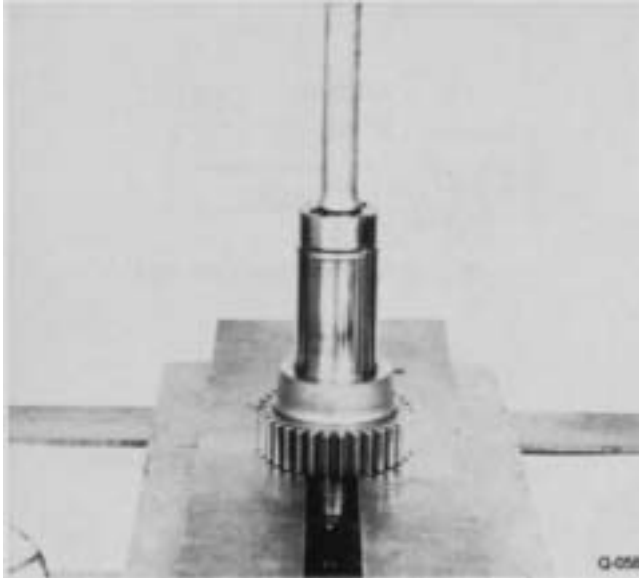

5. Press the 2nd speed gear from countershaft.

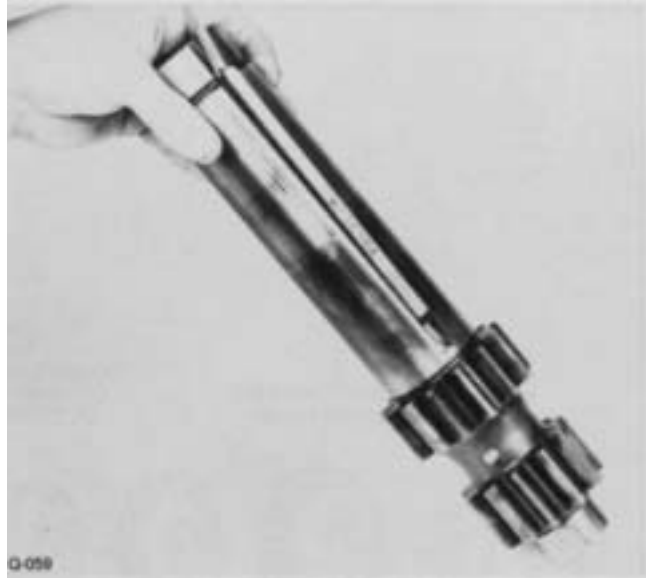

6. If necessary, remove the key and roll pin from countershaft.

G. Removal and Disassembly of Right Reverse Idler Gear Assembly

NOTE: *Since the left and right reverse idler gear assemblies are identical, removal and disassembly of the Right Reverse Idler Gear Assembly should be performed in the same manner as described in Part B of this section.*

CHANGING INPUT SHAFT

SPECIAL PROCEDURE

In some cases, it may be necessary to replace only the input shaft due to clutch wear on the splines.

In these instances, the input shaft can be removed without disassembling the transmission for other than removing the shifting bar housing assembly. Removal of the clutch housing is optional. Following is the special procedure.

REMOVAL AND DISASSEMBLY

1. Remove gear shift lever housing and shift bar housing assemblies from transmission.
2. Remove the front bearing cover.
3. Engage the mainshaft sliding clutches in two gears and remove the drive gear bearing nut.
4. Move the drive gear assembly as far forward as possible and remove the drive gear bearing.
5. Remove the spacer from input shaft.
6. From the front, remove the snap ring from ID of drive gear.
7. Pull the input shaft forward and from splines of drive gear.

REASSEMBLY AND INSTALLATION

1. Install new input shaft into splines of drive gear just far enough to expose snap ring groove in ID of drive gear.
2. Install snap ring in ID of drive gear.
3. Install spacer on shaft against drive gear.
4. Install drive gear bearing on shaft and into case bore.
5. Install a new drive gear bearing nut, left-hand thread. Clean threads of nut and input shaft before applying Loctite sealant to threads of both parts. Use 250-300 ft.-lbs. of torque to tighten nut.
6. Peen nut into milled slots of input shaft.
7. Re-install front bearing cover, shift bar housing and gear shift lever housing assemblies.

NOTE: *The above instructions are for changing the input shaft only. To change the drive gear, removal of the mainshaft assembly and the countershaft bearings is necessary.*

REASSEMBLY AND INSTALLATION

1. CASE-INNER ASSEMBLIES

A. Reassembly and Installation of Right Reverse Idler Gear Assembly



1. If previously removed, install pipe plug in threaded end of idler shaft.



2. Press needle bearing into bore of reverse idler gear.



3. Insert inner face of needle bearing of gear.

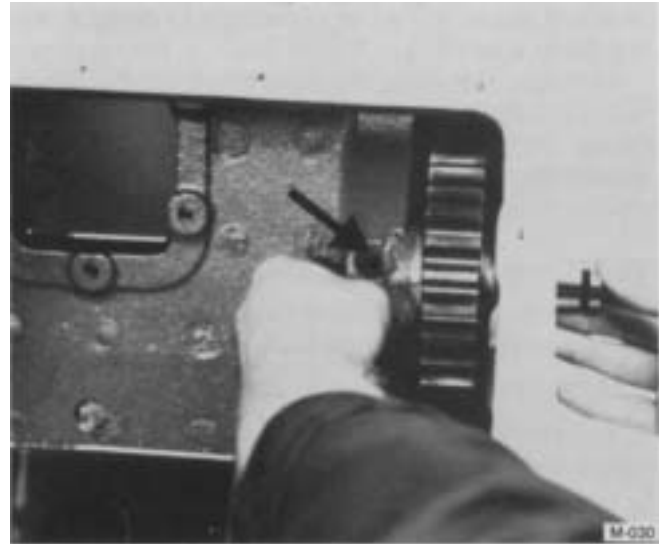

4. With the two thrust washers in position on each side of reverse idler gear, slide the idler shaft through bore in rear of case, gear, washers, and bore of idler shaft support boss inside case. To make certain the slot in rear of idler shaft is properly located to secure lock plate with capscrew in case, align oil channel hole of idler shaft with that in top of idler shaft support boss.



5. Insert lock plate into slot of idler shaft and secure with capscrew.

REASSEMBLY AND INSTALLATION

B. Reassembly of Countershaft Assemblies

NOTE: Since the left and right countershaft assemblies are identical, except for the PTO gears, reassembly of each should be performed in the same manner.

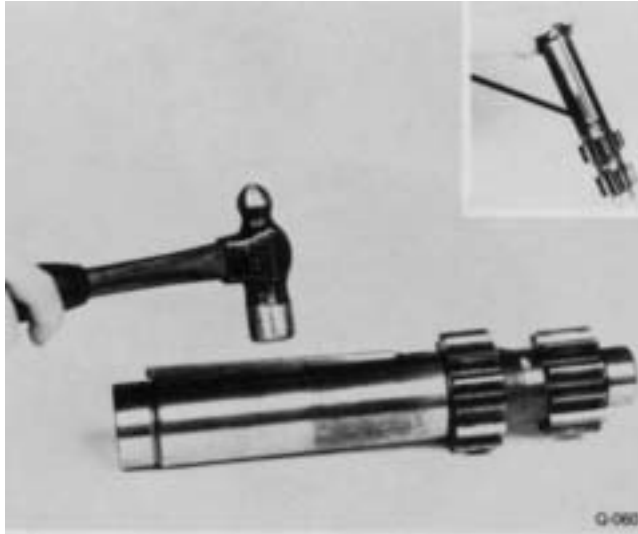

1. If previously removed, install roll pin and long key in keyway of countershaft.

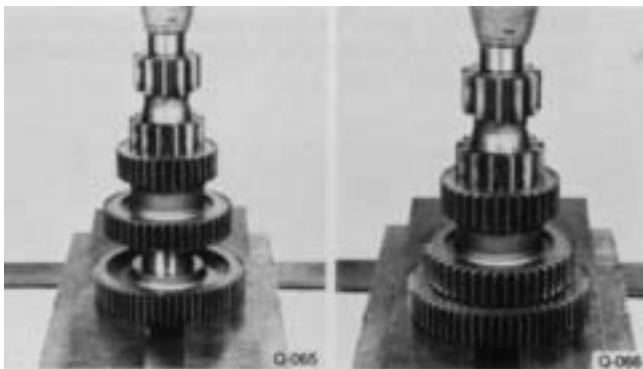

2. Align keyway in gear with key in countershaft and press the 2nd speed gear into position on shaft, long hub of gear toward front of countershaft.

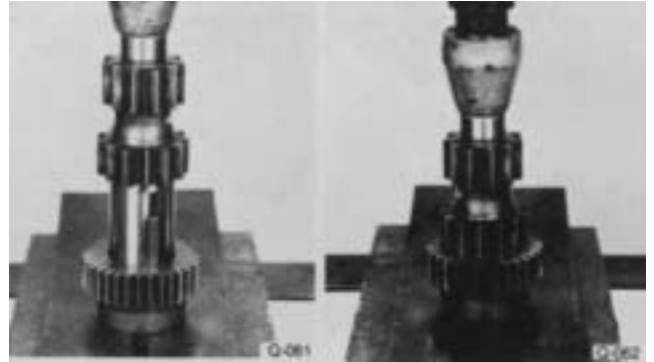

3. Press the 3rd speed gear on countershaft, long hub of gear against 2nd speed gear hub.

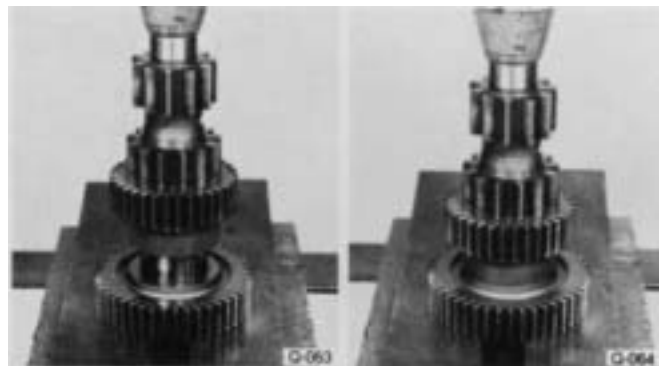

4. Press the 4th speed gear on countershaft against 3rd speed gear.

REASSEMBLY AND INSTALLATION

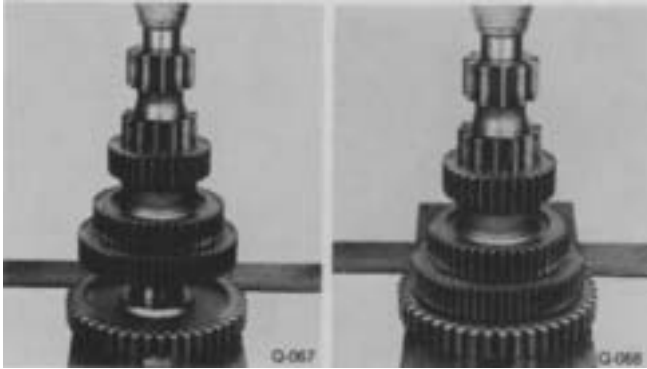

5. Press the power take-off gear on countershaft, bullet nose teeth against 4th speed gear. (The left counteshaft assembly has a 47-tooth PTO gear the right countershaft assembly has a 45-tooth PTO gear. To eliminate confusion during installation, mark the appropriate assembly as "right" and "left".)

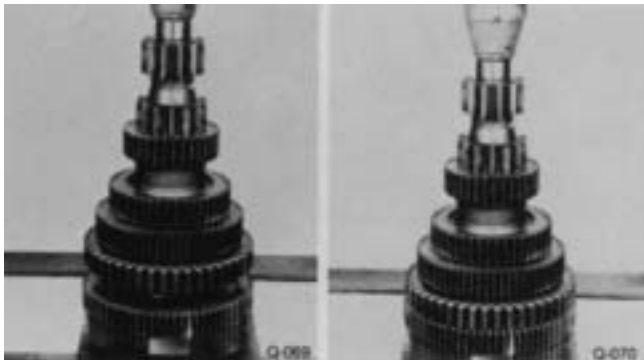

6. Press the drive gear on countershaft against PTO gear.

7. For models so equipped with two snap ring grooves in front of each countershaft, install countershaft gear retaining snap ring in groove nearest to drive gear. Do not install snap ring in other groove of countershaft at this time, as it is intended for the front bearing retaining snap ring.

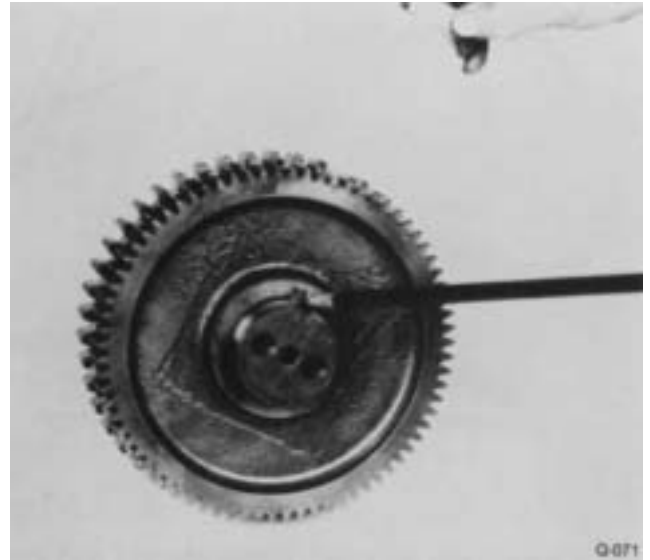

8. **IMPORTANT:** Mark countershaft drive gears for timing. On the drive gear of each countershaft assembly, mark the gear tooth stamped with an "O" that is aligned with the keyway of gear. Use of toolmakers dye of a highly visible color is recommended.

REASSEMBLY AND INSTALLATION

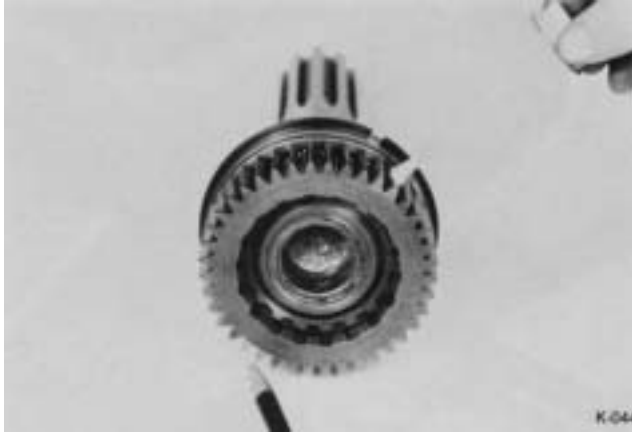

8. **IMPORTANT:** Remove assembly from vise and mark the drive gear for timing. Mark any two adjacent teeth on the drive gear and repeat the same process for the two adjacent teeth directly opposite the first set marked. Use of toolmakers dye of a highly visible color is recommended.



11. Install snap ring in drive gear bearing groove.

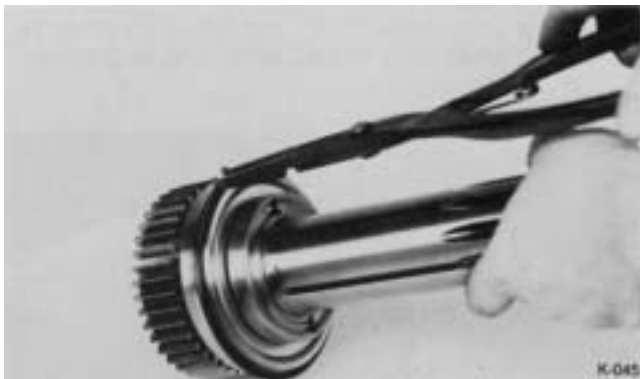

9. Remove the snap ring from drive gear bearing.

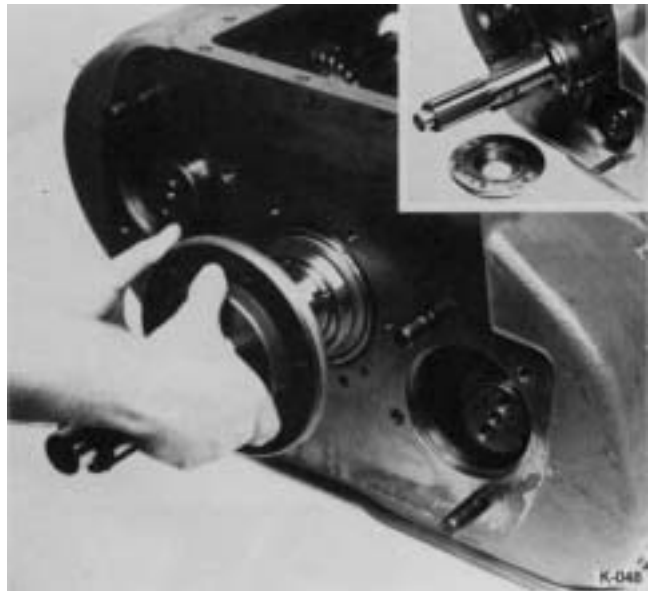

12. Seat bearing in case bore and install the drive gear bearing cover with new gasket, aligning the oil return slot in cover with oil return hole in case. Secure with capscrews.



10. Spread the partially installed countershaft assemblies and insert the drive gear assembly through front bore from inside case. Seat the drive gear bearing in case bore and move assembly forward until snap ring groove in bearing is exposed.

REASSEMBLY AND INSTALLATION

E. Completed Installation of Left

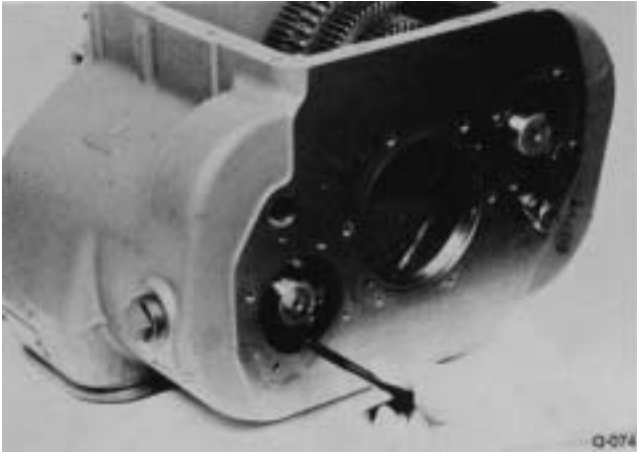

1. Insert countershaft support tool in rear bearing bore.

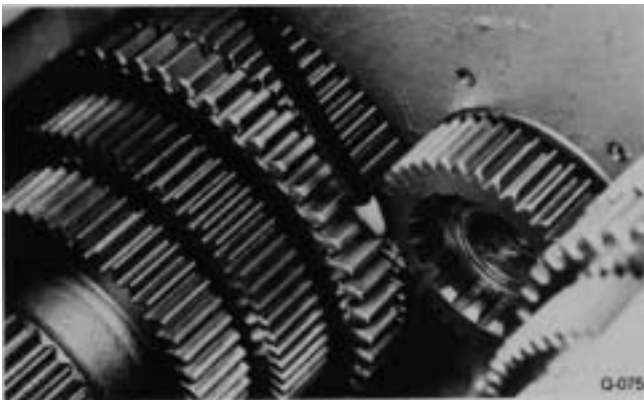

2. Mesh the marked tooth of left countershaft drive gear with either set of two marked timing teeth of main drive gear.



3. With timing teeth still in mesh, install countershaft front bearing. Center countershaft in case bore using a small screwdriver inserted through bearing I.D. and in bell center of either threaded hole in case bore.



4. Install retainer plate, secure with capscrews, and lockwire. For models so equipped with groove in countershaft for front bearing retaining snap ring, install snap ring in groove.

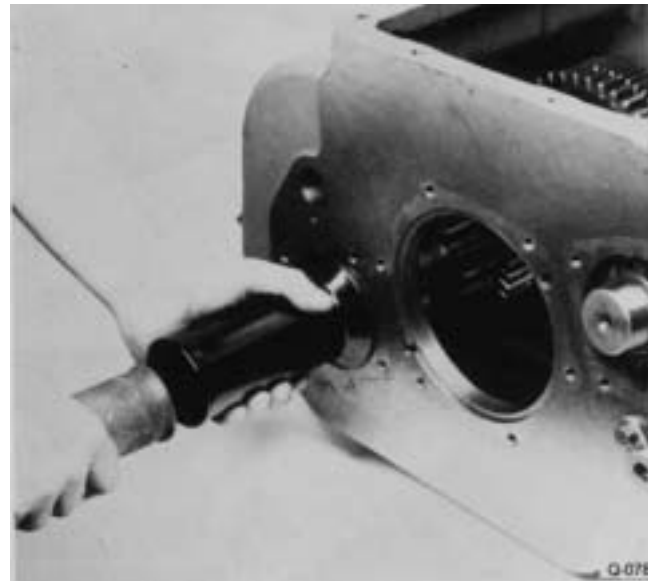

5. Remove countershaft support tool from rear case bore and install countershaft rear bearing with the larger I.D. lead chamfer toward front of transmission. (Note: If damage to original bearing resulted from punch and maul removal, replace with new rear bearing.)

REASSEMBLY AND INSTALLATION

C. Partial Installation of Countershaft Assemblies

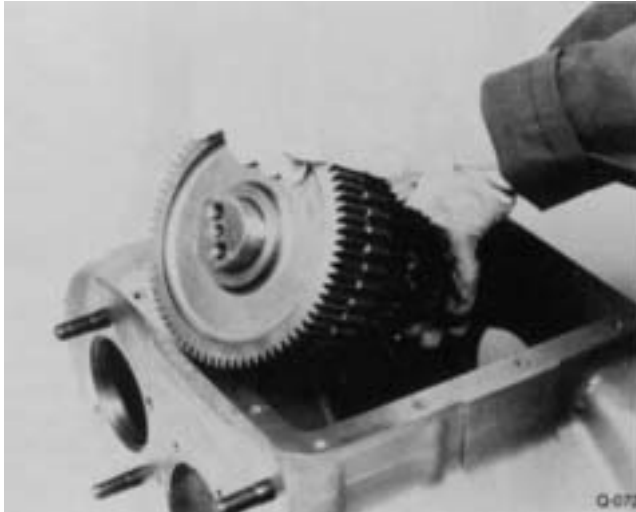

1. Place the left countershaft assembly with the 47-tooth PTO gear into position in case, small end through the left rear countershaft bore. Do not install bearings at this time,



2. Place the right countershaft assembly with the 45-tooth PTO gear into position in case, small end through right rear countershaft bore. Do not install bearings at this time.

D. Reassembly and Installation of Main Drive Gear Assembly

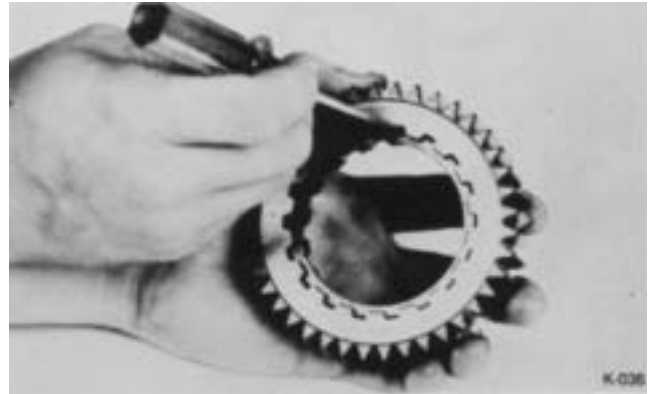

1. If previously removed, install the snap ring in I.D. of main drive gear.



2. Install the main drive gear on input shaft, engaging internal splines of gear with teeth on shaft, snap ring of gear toward the front.



REASSEMBLY AND INSTALLATION

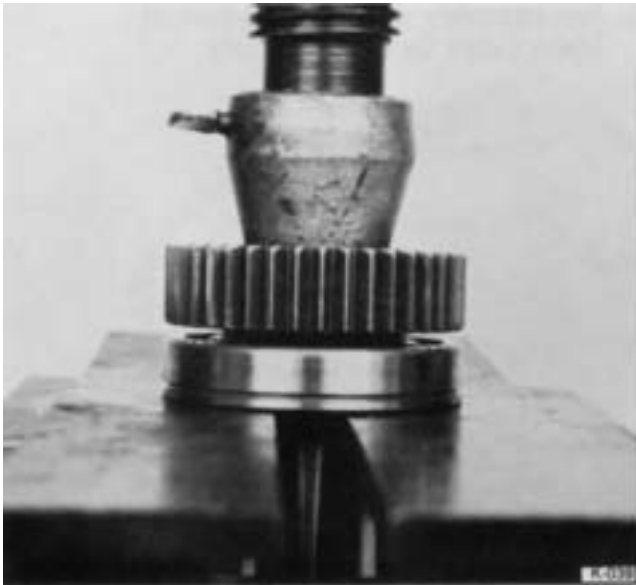

4. Press the drive gear bearing on input shaft, bearing shield to the front.



5. Clean threads of input shaft and apply loctite grade 277 sealant to threads of new drive gear bearing nut. Do not reuse old nut.

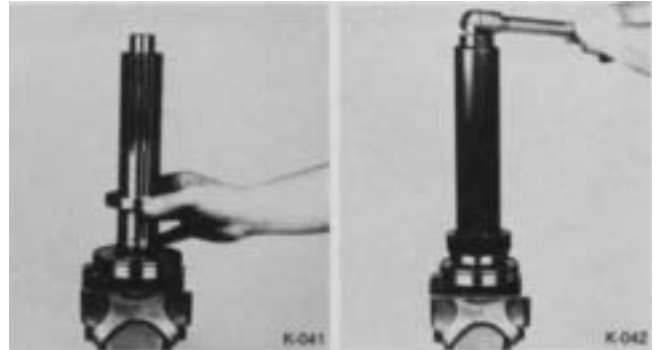

6. Secure assembly in vise, pilot end up, on drive gear O.D. The vise used should be equipped with either brass jaws or wood blocks to prevent damage to the teeth of drive gear. Using a drive gear bearing nut installer, install the nut on input shaft, left hand threads, with 250-300 ft. lbs. of torque.



7. With a punch and maul, peen the nut into the two milled slots of input shaft.

REASSEMBLY AND INSTALLATION

F. Partial Reassembly of Output Shaft Assembly

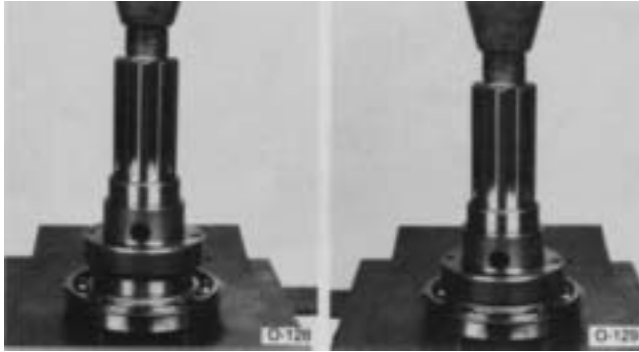

1. Press the front bearing on output shaft, snap ring to the rear.



2. Clean threads of output shaft and bearing nut. Apply loctite grade 277 sealant to threads of nut.

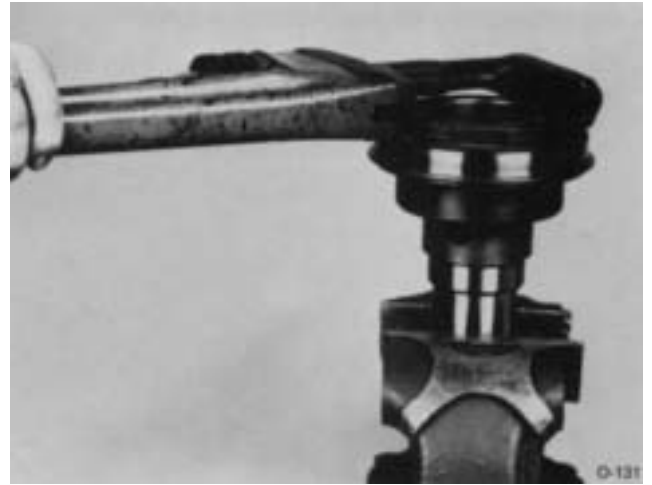

3. Install the bearing nut on threads of output shaft and torque to 250-300 ft. lbs.



4. Position the key spacer ring on output shaft using the two 5/16-24 x 5/8" cap screws, but do not tighten.

REASSEMBLY AND INSTALLATION

G. Reassembly of Mainshaft Assembly

1. Place mainshaft in vise equipped with brass jaws or wood blocks, pilot end down. (Note: If previously removed, install all corresponding snap rings in mainshaft gears with the exception of reverse gear.)



2. Install 3rd speed gear limit washer with flat side down in 4th groove of mainshaft. Rotate washer to align splines of washer with those of the mainshaft and install the long key in mainshaft keyway.

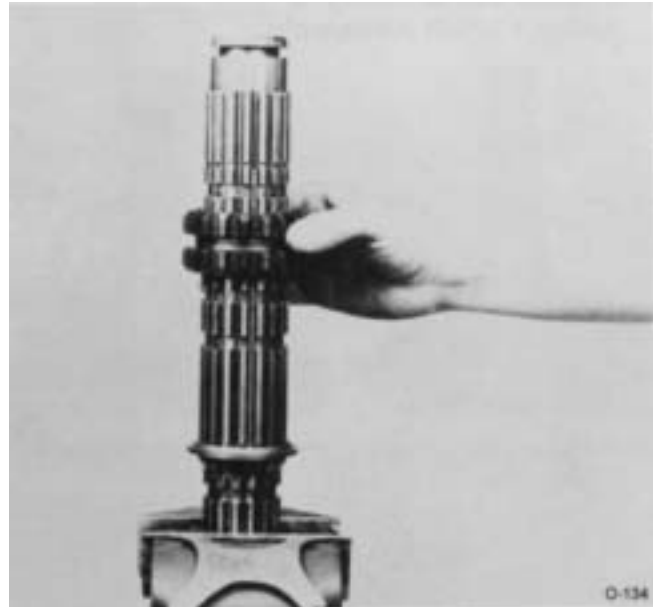

3. Install 2nd-3rd speed sliding clutch, aligning missing internal spline of sliding clutch with key.

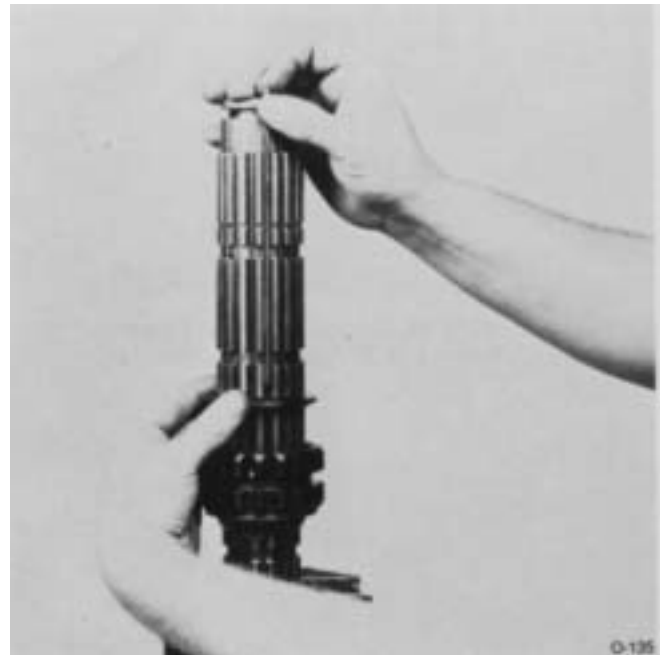

4. Remove key and install 2nd speed gear limit washer, flat side up, in next groove of mainshaft. Rotate washer to align splines of washer with those of mainshaft and reinsert key.

NOTE: The long key is moved downward to engage each limit washer as they are positioned on mainshaft.

REASSEMBLY AND INSTALLATION

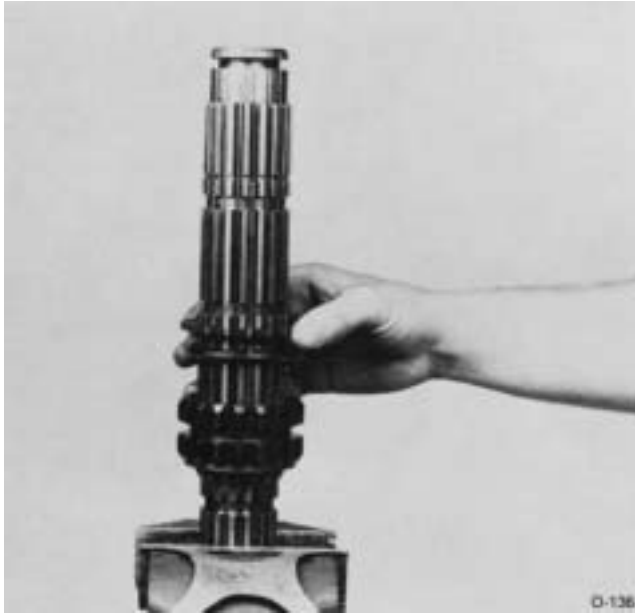

5. Install spacer against 2nd speed limit washer.

NOTE: Gear limit washers are internally splined and locked to mainshaft by key. Gear spacers are externally splined to engage with splines in gear hubs. There is one limit washer and one spacer for each gear in mainshaft assembly.

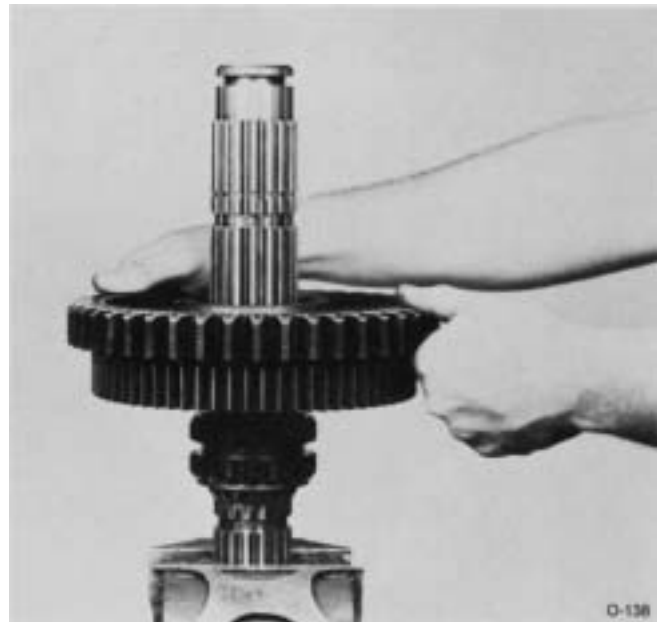

7. Install 2nd speed gear, clutching teeth up.

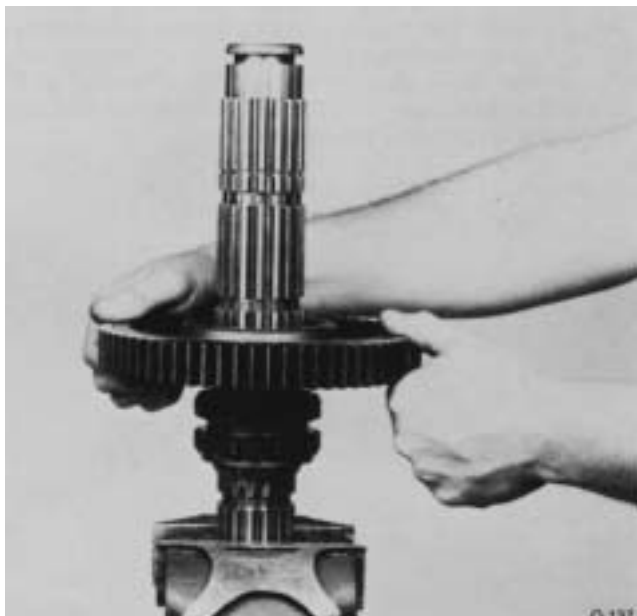

6. Install 2nd speed gear, clutching teeth down. Engage clutching teeth of gear with external splines of spacer.

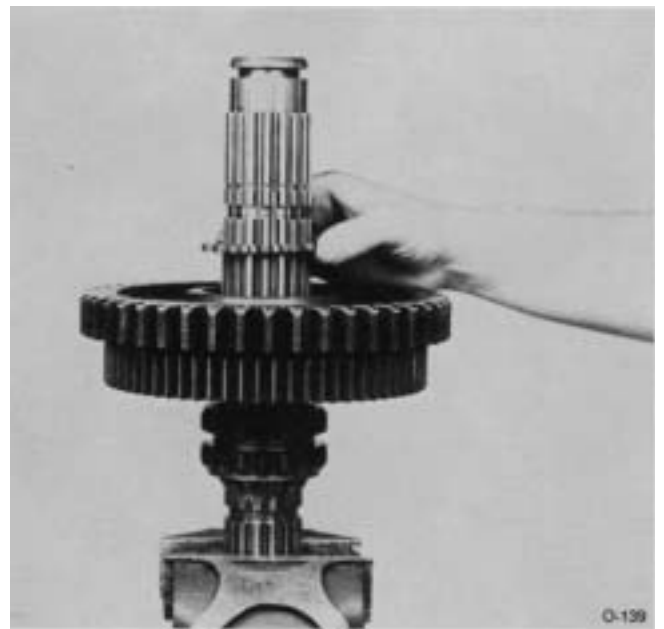

8. Install spacer in 1st speed gear, engaging external splines of spacer with clutching teeth of gear.

REASSEMBLY AND INSTALLATION

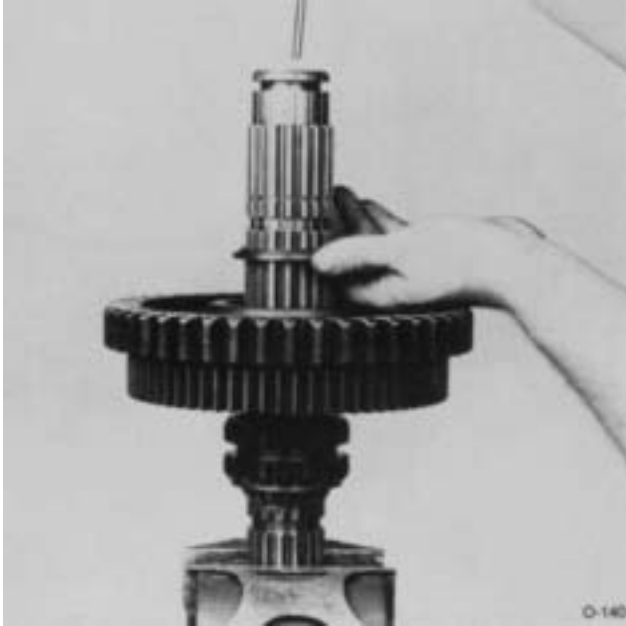

9. Remove key and install 1st speed limit washer, flat side against spacer.

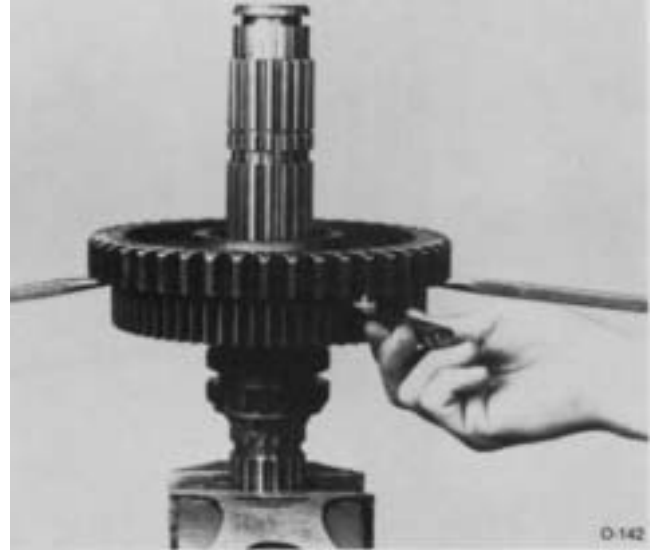

11. Insert two large screwdrivers between 1st and 2nd speed gears. Apply slight downward pressure on screwdriver handles to spread gears evenly. Making certain gear hubs are parallel, insert feeler gage between hubs. Correct axial clearance should be from .005" to .012". If the clearance is less than the minimum .005" tolerance, the limit washer in the 1st speed gear should be replaced by a lower limit washer. This will increase the axial clearance between the gears. If the clearance checked is greater than the maximum .012" tolerance, a higher limit washer should be installed in the 1st speed gear. This would decrease the axial clearance between the gears.

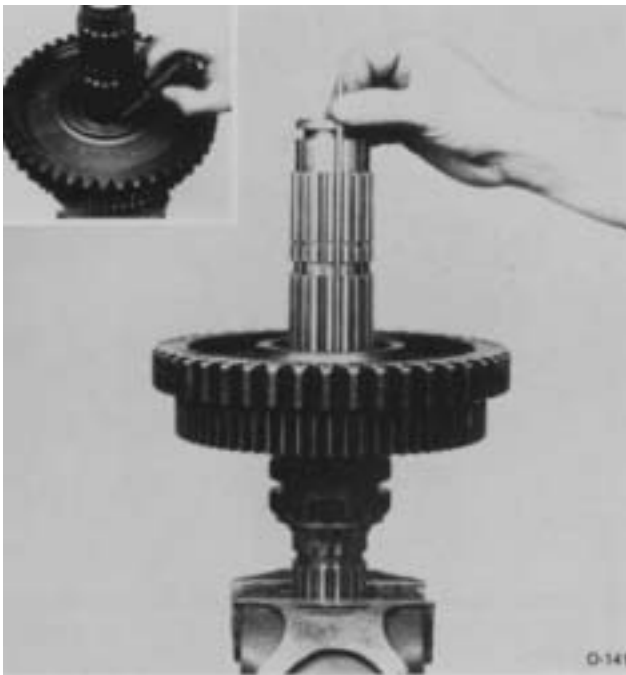

10. Rotate washer to align splines of washer with those of mainshaft and reinsert key.

SETTING CORRECT AXIAL CLEARANCES FOR MAINSHAFT GEARS

Axial Clearance (End Play) Limits Are:

Reverse speed gear — Minimum of .005"

Forward speed gears — .005" to .012"

Washers are used to obtain the correct limits; six thicknesses are available as follows:

LIMITS (INCH)	COLOR CODE
.248-.250	WHITE
.253-.255	GREEN
.258-.260	ORANGE
.263-.265	PURPLE
.268-.270	YELLOW
.273-.275	BLACK
*	PLUS RED

* Note: New style limit washers come in full range of tolerances and corresponding colors listed above "plus red". (Example: "Orange plus red" limit washer has an inch limit thickness of .258-.260.)

Refer to Illustrated Parts Lists for washer part numbers.

Always use the .248-.250" low limit washer ("white" or "white plus red") in the 1st and 3rd speed gear positions as shown at right.

** On overdrive models, the (4th) speed gear becomes (5th) speed gear.

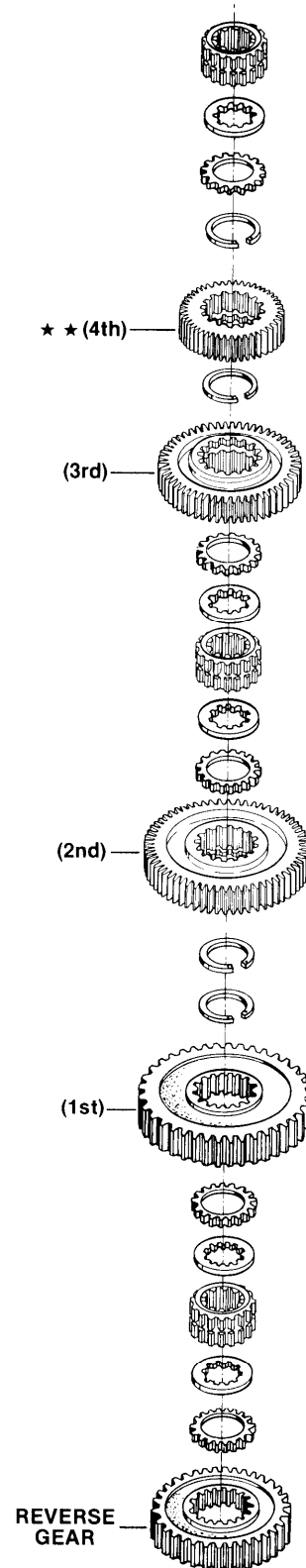

REASSEMBLY AND INSTALLATION

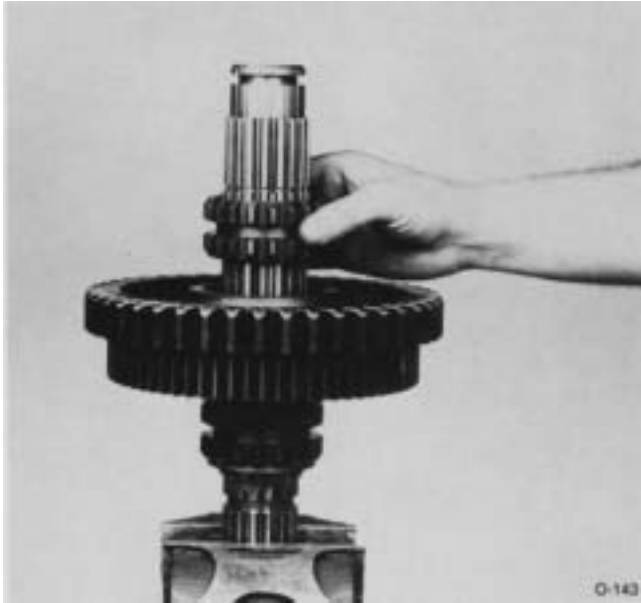

12. Install 1st-reverse speed sliding clutch, aligning missing internal spline of sliding clutch with key in mainshaft.

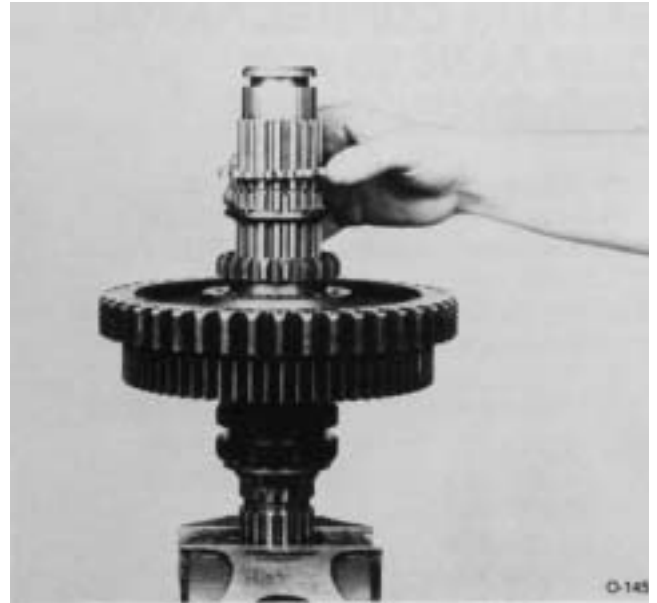

14. Install spacer against reverse gear limit washer.



13. Remove key and install reverse gear limit washer, flat side up, in last groove of mainshaft. Rotate washer to align splines of washer with those of mainshaft and reinsert key.



15. Install snap ring in snap ring groove at rear of mainshaft.

REASSEMBLY AND INSTALLATION



16. Reposition mainshaft assembly in vise, pilot end up.

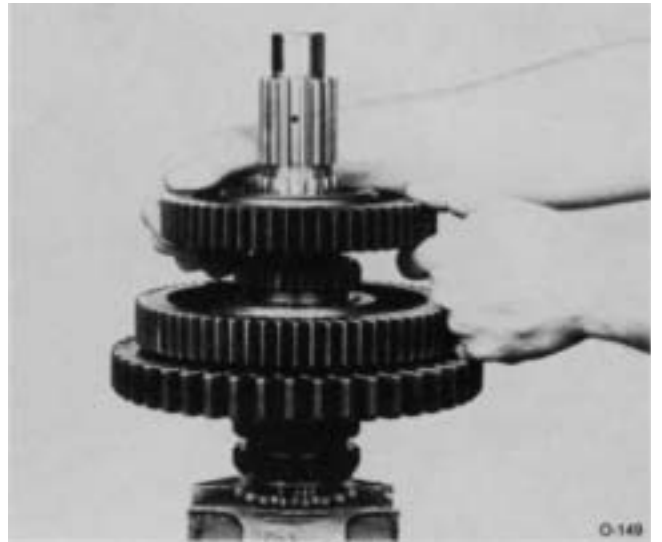

18. Install 3rd speed gear, clutching teeth down. Engage clutching teeth of gear with external splines of spacer.



17. Install spacer against flat side of 3rd speed gear limit washer.



19. Install 4th speed gear, clutching teeth up, against 3rd speed gear.

REASSEMBLY AND INSTALLATION



- 20.** Install spacer in 4th speed gear, engaging external splines of spacer with clutching teeth of gear.



- 22.** Check axial clearances and make adjustments, if necessary, between the 3rd and 4th speed gears in the same manner as performed between the 1st and 2nd speed gears (step #n).



- 21.** Install 4th speed gear limit washer, flat side against spacer, in 4th speed gear. Rotate washer to align splines of washer with those of mainshaft and install short key in mainshaft keyway.



- 23.** Install 4th-5th speed sliding clutch, aligning missing internal spline of sliding clutch with key in mainshaft.

REASSEMBLY AND INSTALLATION



24. Remove mainshaft assembly from vise. Install reverse gear on mainshaft over snap ring in rear, clutching teeth toward front, and move it against 1st speed gear, engaging clutching teeth of gear with external splines of spacer.



2. With the reverse gear as far forward as possible, install the mainshaft assembly into position in case, meshing corresponding gears on left countershaft with those on mainshaft.

H. Partial Installation of Mainshaft

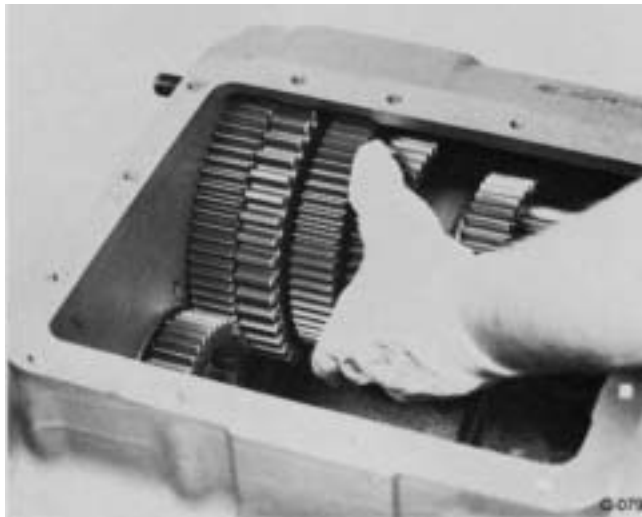

1. Move the right countershaft assembly as far as possible toward case wall.

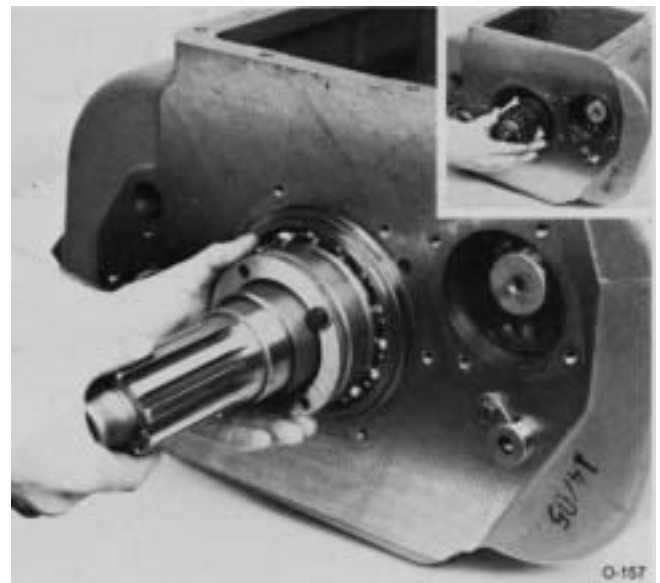

3. Temporarily install the coupler, counterbore toward front of transmission, and partially reassembled output shaft assembly, engaging splines of output shaft with those of coupler, to center the rear of mainshaft assembly.

REASSEMBLY AND INSTALLATION

I. Completed Installation of Right Countershaft Assembly

NOTE: Left countershaft assembly must remain in time with main drive gear when timing right countershaft assembly.

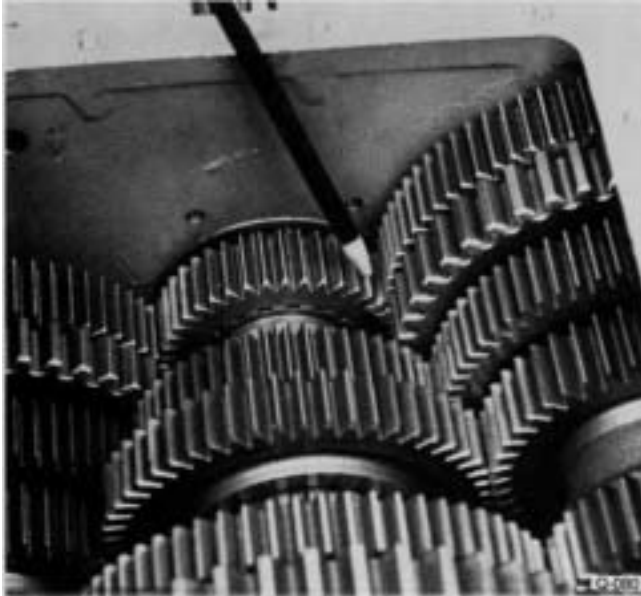

1. With the right countershaft parallel with mainshaft, mesh the marked tooth of right countershaft drive gear with the remaining two marked timing teeth of main drive gear.

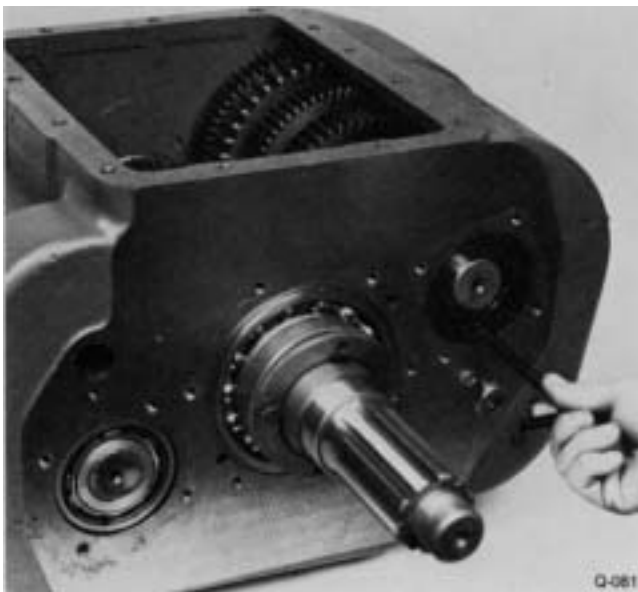

2. Insert countershaft support tool in rear bearing bore.

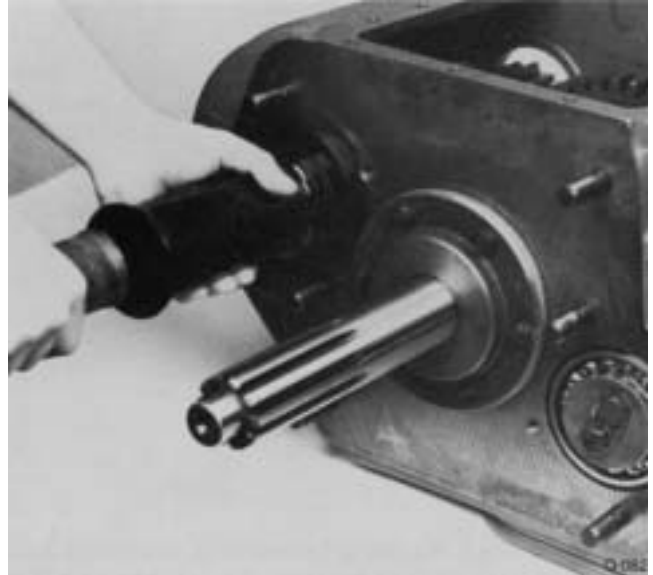

3. With timing teeth still in mesh. install countershaft front-bearing. Center countershaft in case bore using a small screwdriver inserted through bearing I.D. and in bell center or either threaded hole in end of shaft.

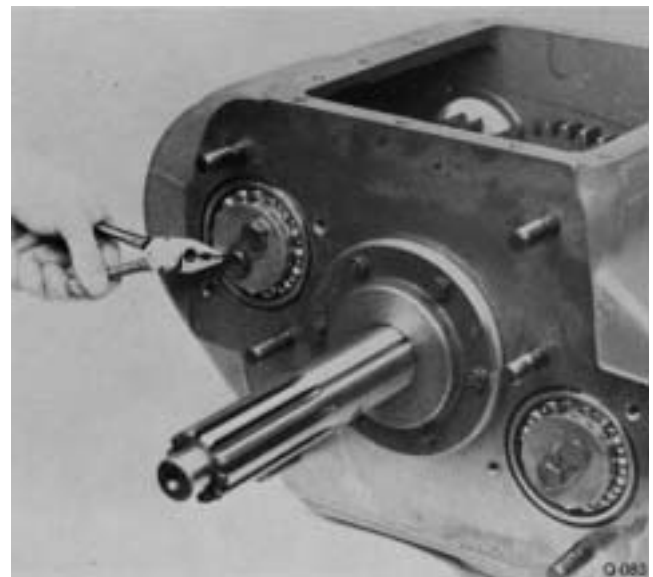

4. Install retainer plate, secure with capscrews, and lockwire. For models otherwise equipped with front bearing retaining snap ring in groove of countershaft, install snap ring.

REASSEMBLY AND INSTALLATION



5. Remove countershaft support tool from rear case bore and install countershaft rear bearing with the larger I.D. lead chamfer toward front of transmission. (NOTE: If damage to original bearing resulted from punch and maul removal, replace with new rear bearing.)

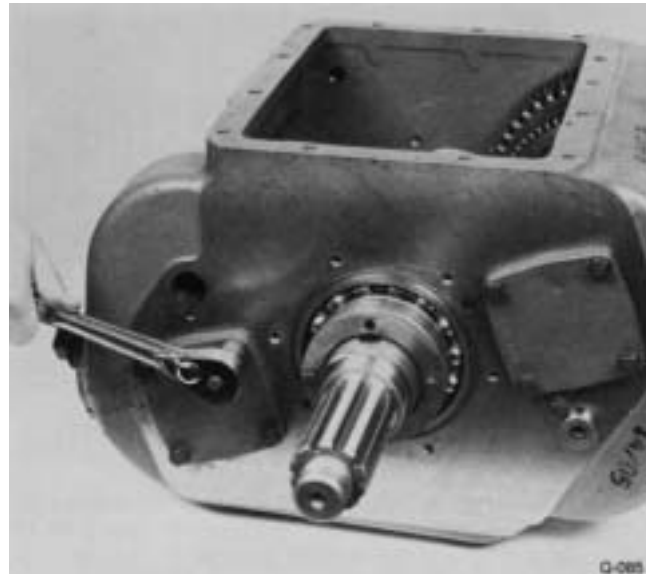

7. If properly timed, install both countershaft rear bearing covers with new gaskets and secure-to case with capscrews.

J. Reassembly and Installation of Left Reverse Idler Gear Assembly

NOTE: Since the left and right reverse idler gear assemblies are identical, reassembly and installation of the Left Reverse Idler Gear Assembly should be performed in the same manner as described in Part I-A of this section.

K. Completed Installation of Mainshaft Assembly

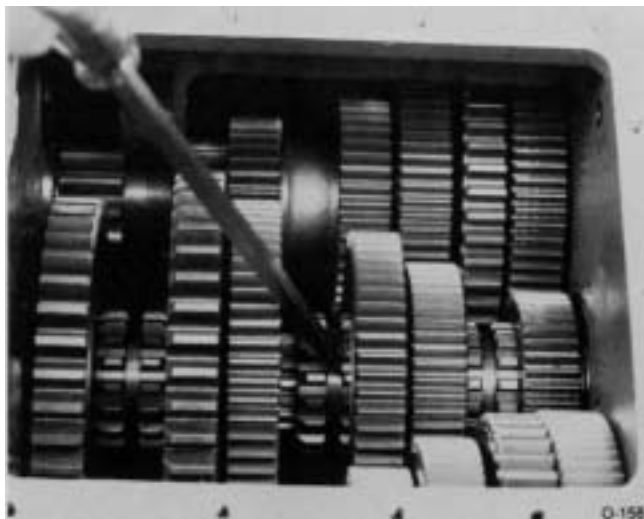

6. Shift the mainshaft sliding clutches into all gear positions with a screwdriver. A sliding clutch that cannot be shifted into gear indicates that the drive gear set is out of time. The right countershaft bearings would then need to be removed and the countershaft retimed with the mainshaft. The transmission is properly timed if the sliding clutches can be shifted into all mainshaft gears. (NOTE: Do not shift the transmission into two gears at the same time. This will prevent the mainshaft and countershaft assemblies from rotating.)

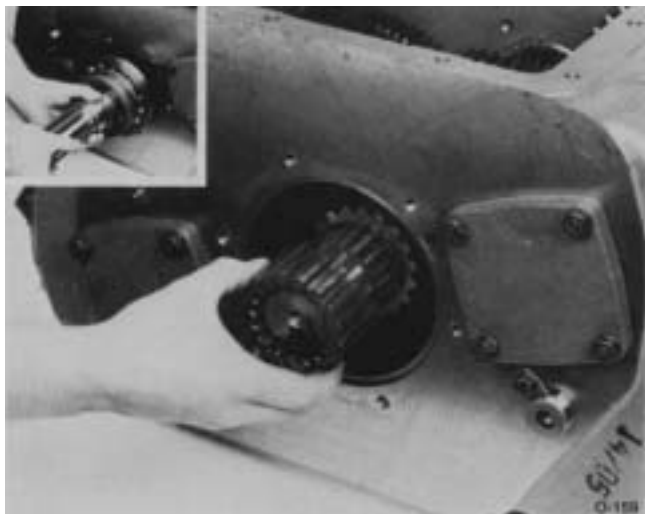

1. Remove temporarily installed output shaft assembly from case bore and coupler from rear

REASSEMBLY AND INSTALLATION

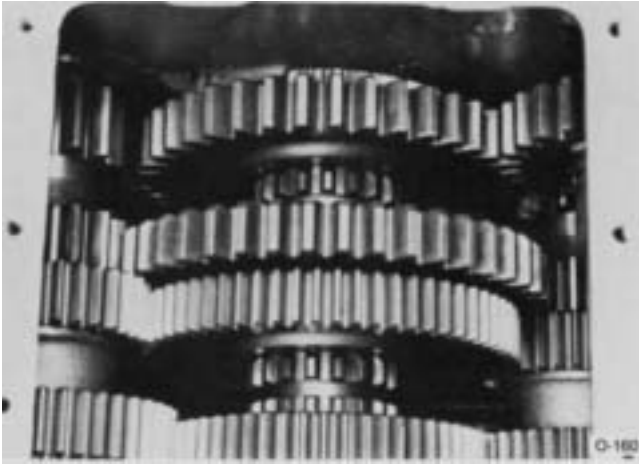

2. Move the reverse gear to the rear on mainshaft as far as possible, meshing teeth of gear with teeth of the two reverse idler gears.

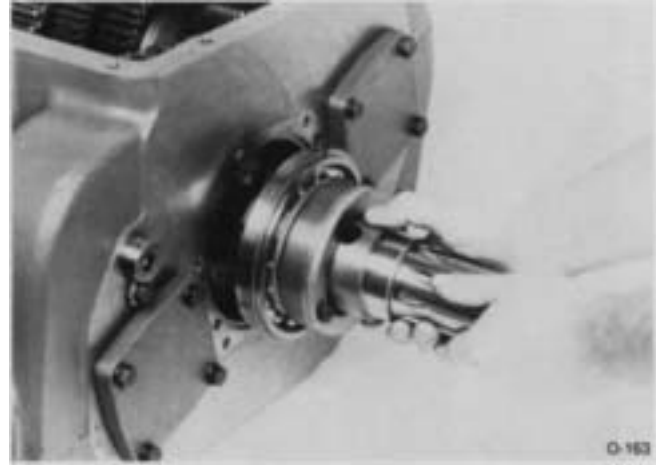

2. Reinstall output shaft assembly over mainshaft, seating bearing in case bore. Make sure splines in output shaft engage splines of coupler.



3. With mainshaft forward and reverse gear to the rear, seat the reverse gear spacer previously installed on shaft in hub of gear, and install the snap ring in ID of reverse gear.



3. Install two flat retainers in bores of output shaft to key in slot of mainshaft.

L. Completed Reassembly and Installation of Output Shaft Assembly



1. Reinstall coupler on splines of mainshaft with the counterbore toward the front of transmission.

REASSEMBLY AND INSTALLATION

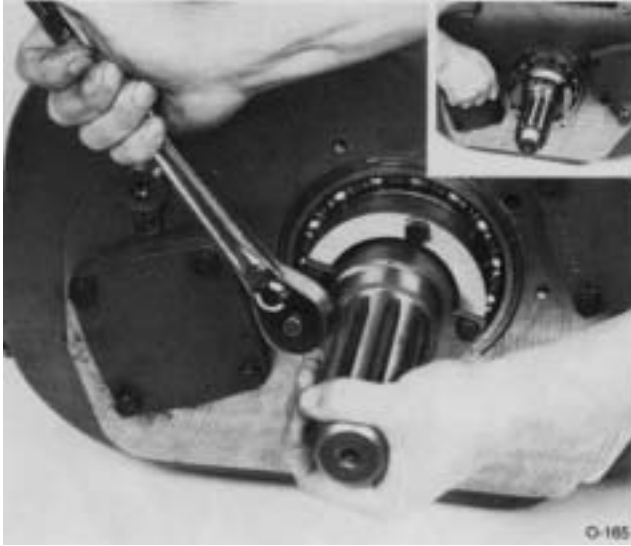

4. Secure retainers with 5/16-24 x 1" cap screws and tighten all cap screws in spacer ring evenly. install lockwire to include all four tightened cap screws in spacer ring.

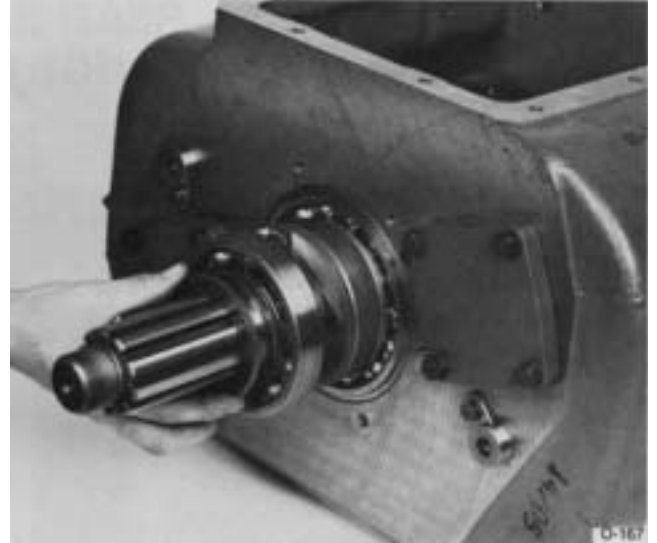

6. Install bearing washer on output shaft against outer bearing, chambered I.D. toward bearing.

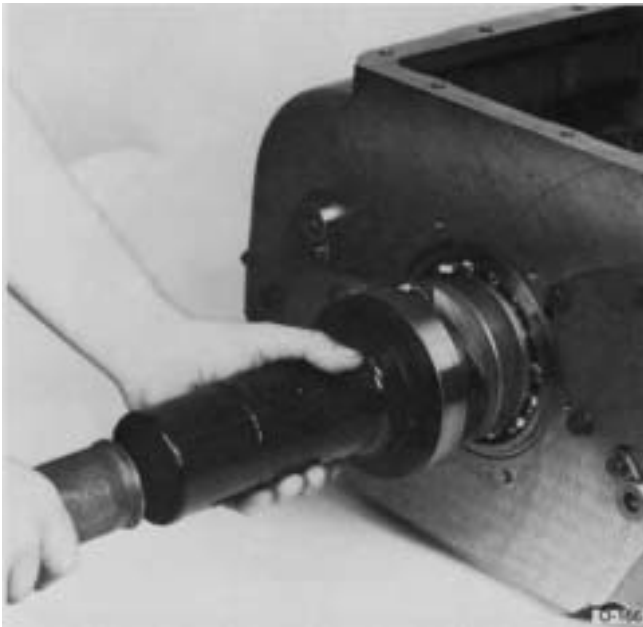

5. Install outer bearing on output shaft seating it against shoulder of shaft.

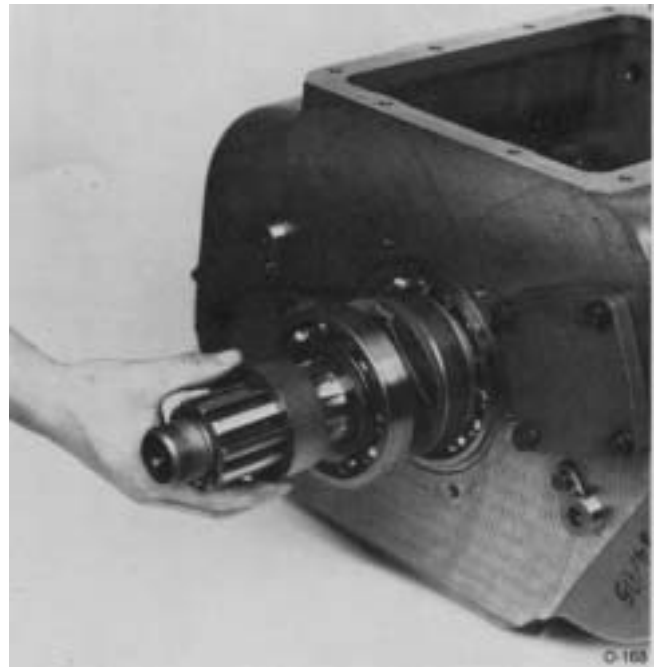

7. Install the speedometer drive gear or replacement spacer on output shaft against bearing washer.

REASSEMBLY AND INSTALLATION

II. CLUTCH HOUSING, REAR BEARING COVER ASSEMBLY, AND COMPANION FLANGE OR YOKE

A. Installation of Clutch Housing

NOTE: For models otherwise equipped with Amid-ship Assembly, refer to illustration provided in Options Section of this manual.

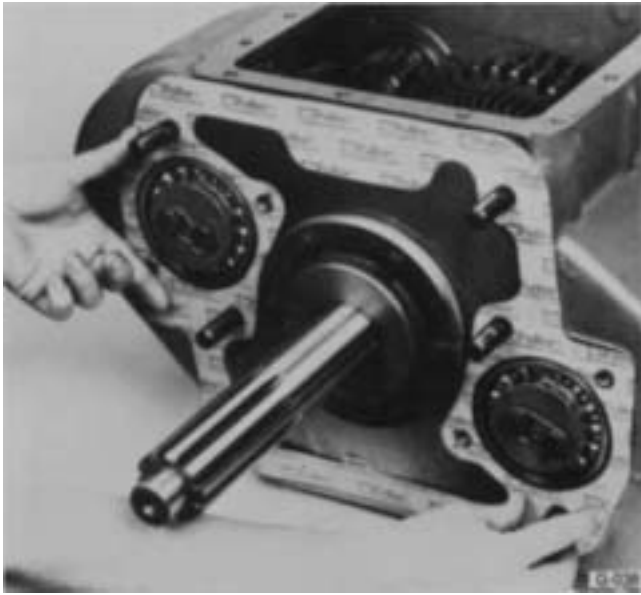

1. Apply white grease to new clutch housing gasket and install in position on case.



2. Place clutch housing in position on the six studs in front of case, aligning on drive gear cover.

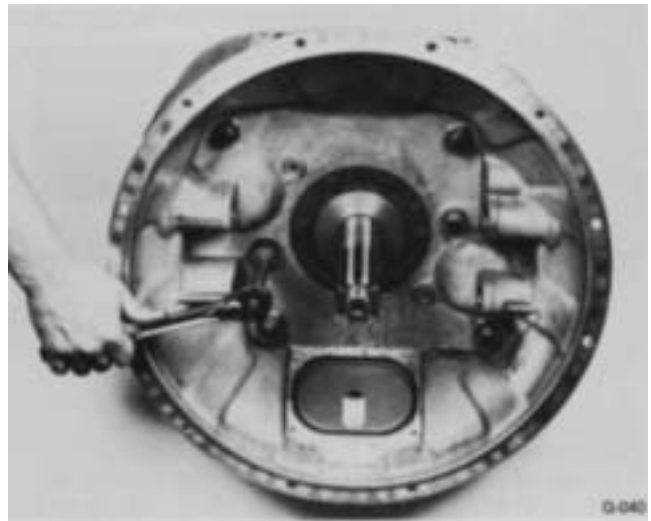

3. Install the six nuts with washers or lockwashers on studs and tighten. See Torque Recommendations Section.

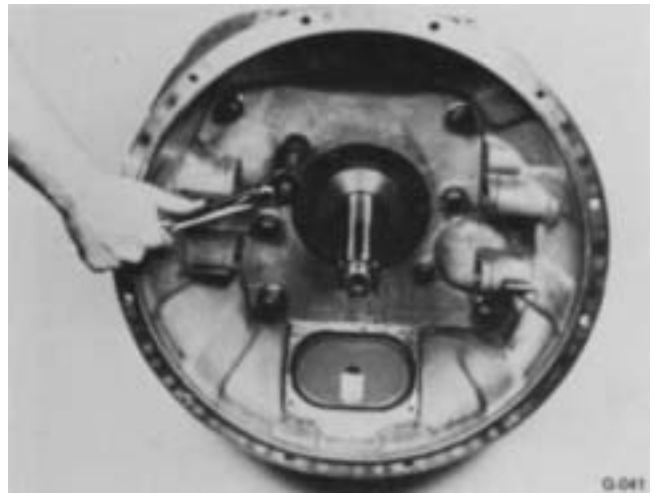

4. Install the four capscrews with lockwashers and tighten. See Torque Recommendations Section.
5. Install the clutch release mechanism if transmission is so equipped.

REASSEMBLY AND INSTALLATION

B. Reassembly and Installation of Rear Bearing Cover Assembly



1. Install new oil seal in rear bearing cover if original seal was previously removed. A spring is visible on one side of seal. Install this side with spring toward front of transmission.



2. Install rear bearing cover with new gasket evenly on output shaft to seat outer bearing in cover, aligning oil slot in cover and gasket with hole in case.



3. Install attaching cap screws and tighten securely. www.progearandtransmission.com | www.pgtruckparts.com
Secure Bearing Cover and Seal, 32805 | +1 (877)-776-4600 | +1 (407)-872191 | parts@eprogear.com

C. Installation of Companion Flange or Yoke

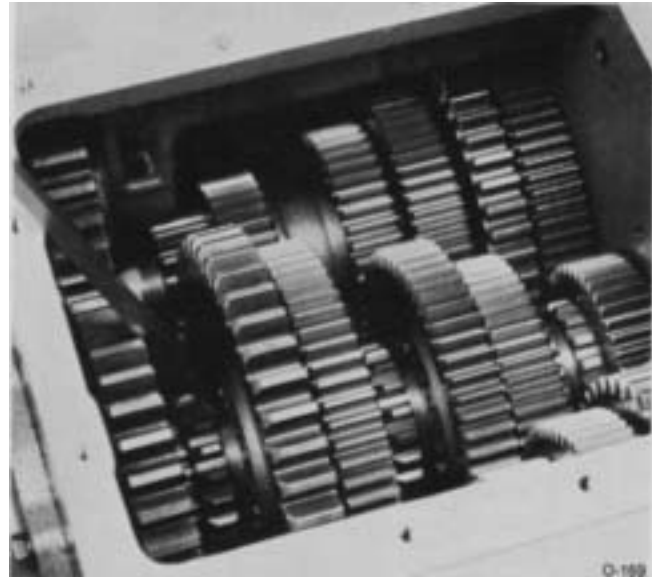

1. Lock the mainshaft by engaging any two mainshaft gears with the sliding clutches.

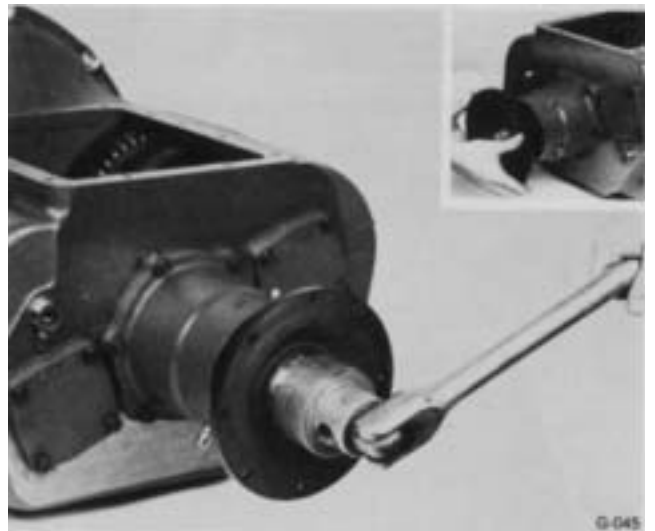

2. Install companion flange or yoke on output shaft splines and secure with output shaft nut, using 400-450 ft. lbs. of torque.

REASSEMBLY AND INSTALLATION

III. SHIFTING CONTROLS

A. Installation of Shift Bar Housing Assembly

NOTE: For detailed reassembly instructions of shift bar housing assembly, see *Shifting Controls Section, Part II-B*, of this manual.

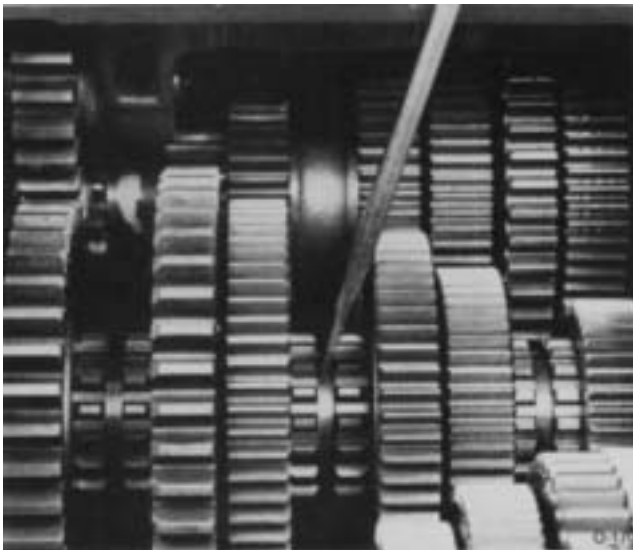

1. Place all three mainshaft sliding clutches in the neutral position.

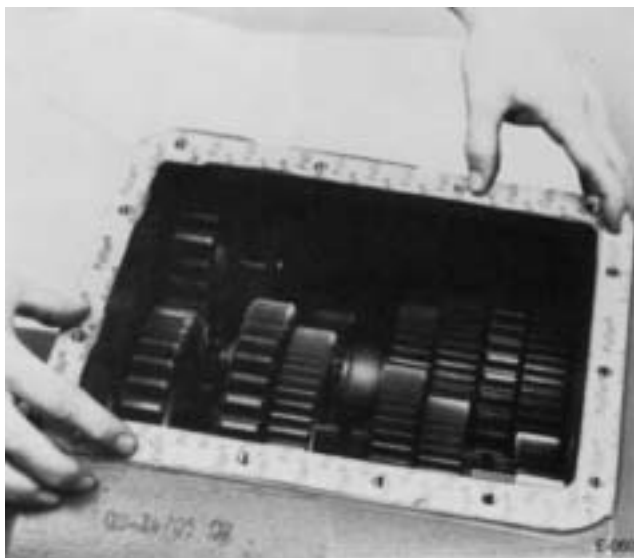

2. Apply white grease to new shift bar housing gasket and install in position on case.



3. Make certain that all three shift bars of assembly are in the neutral position.



4. Install the shift bar housing assembly on transmission, fitting shift yokes into corresponding yoke grooves of mainshaft sliding clutches.



5. Install the thirteen capscrews in flange holes of housing and tighten, remembering to include the two timing eyes in position on housing corners opposite (407) 872491 | parts@eprogear.com

REASSEMBLY AND INSTALLATION

B. Installation of Gear Shift Lever Housing Assembly.

NOTE: For detailed reassembly instructions of gear shift lever housing assembly, see *Shifting Controls Section, Part I-B, of this manual.*

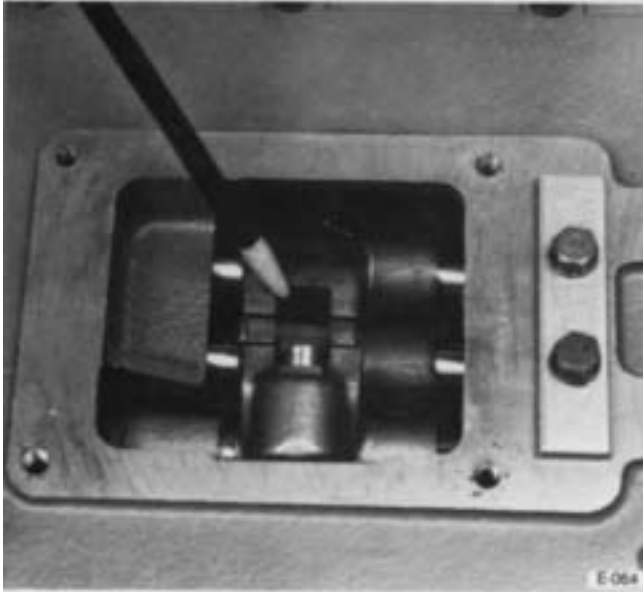

1. Make certain that the shift block notches in the shift bar housing assembly are aligned in the neutral position.



2. Apply white grease to new gear shift lever housing gasket and install in position on shift bar housing assembly.

3. Install gear shift lever housing assembly, fitting tang of-gear lever into notches of shift bar housing assembly blocks and yokes.

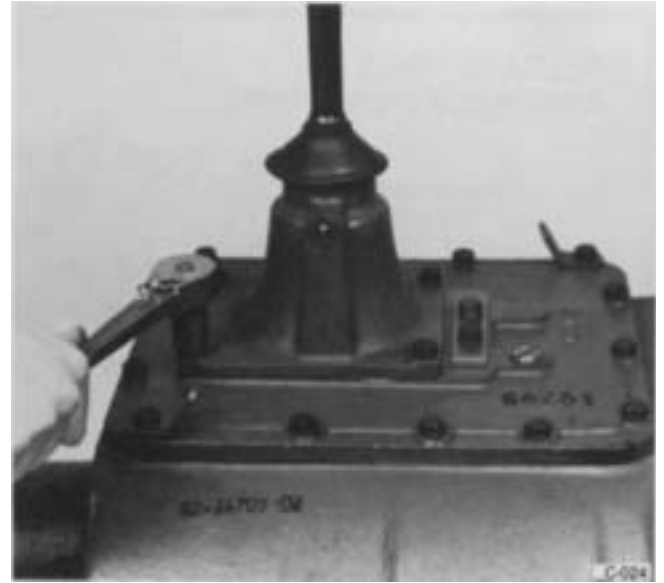

4. Install the four cap screws in flange holes of housing and tighten.

TOOL REFERENCE

Some repair procedures pictured in this manual show the use of specialized tools. Their actual use is recommended as they make transmission repair easier, faster, and prevent costly damage to critical parts.

But for the most part, ordinary mechanic's tools such as socket wrenches, screwdrivers, etc., and other standard shop items such as a press, mauls and soft bars are all that is needed to successfully disassemble and reassemble any Fuller Transmission.

The specialized tools listed below can be

obtained from a regular tool supplier or made from dimensions as required by the individual user. Detailed Fuller prints and a booklet which gives the use and description of these tools are available upon request by writing:

Eaton Corporation
Transmission Division
Technical Service Dept.
P.O. Box 4013
Kalamazoo, Michigan 49003

PAGE	TOOL	HOW OBTAINED
20	Tension Spring Driver	Made from Fuller Print T-1 1938
29	Bearing Puller, Large (Jaw Type)	Tool Supplier
32	Impact Puller (%-13 Threaded End)	Tool Supplier
33	Countershaft Bearing Puller	Made from Fuller Print T-9824
36, 39, 49, 56	Snap Ring Pliers, Large	Tool Supplier
40, 48	Drive Gear Bearing Nut Remover/Installer	Made from Fuller Print T-22553-D or T-22553-C
50,60	Countershaft Support Tool	Made from Fuller Print T-22247
50,60,61,63,65	Bearing Drivers (Flange-End Type)	Made from Fuller Print Print Series T-18042*
65	Oil Seal Driver	Made from Fuller Print T-1 8088-20 or T-18088-34
65	Torque Wrench, 1000 Ft.-Lb. Capacity	Tool Supplier

*Dimensions necessary to determine specific tool number required.

Copyright Eaton Corporation, 2012. Eaton hereby grant their customers, vendors, or distributors permission to freely copy, reproduce and/or distribute this document in printed format. It may be copied only in its entirety without any changes or modifications. THIS INFORMATION IS NOT INTENDED FOR SALE OR RESALE, AND THIS NOTICE MUST REMAIN ON ALL COPIES.

Note: Features and specifications listed in this document are subject to change without notice and represent the maximum capabilities of the software and products with all options installed. Although every attempt has been made to ensure the accuracy of information contained within, Eaton makes no representation about the completeness, correctness or accuracy and assumes no responsibility for any errors or omissions. Features and functionality may vary depending on selected options.

For spec'ing or service assistance, call 1-800-826-HELP (4357) or visit www.eaton.com/roadranger. In Mexico, call 001-800-826-4357.

Roadranger: Eaton and trusted partners providing the best products and services in the industry, ensuring more time on the road.

Eaton Corporation

Vehicle Group
P.O. Box 4013
Kalamazoo, MI 49003 USA
800-826-HELP (4357)
www.eaton.com/roadranger

Printed in USA



BACKED BY

Roadranger

Pro Gear and Transmission, Inc | www.progearandtransmission.com | www.pgtruckparts.com
906 West Gore St, Orlando, FL, 32805 | +1 (877)-776-4600 | +1 (407)-872191 | parts@eprogear.com