



**SPICER**<sup>®</sup>  
DRIVETRAIN COMPONENTS



**Pro Gear**  
AND TRANSMISSION

## Dana DS404 - 3.36 Single Reduction Tandem Drive Axle

Pro Gear's Dana Single Reduction Tandem Drive High Performance Series Parts Manual to assist in identifying your Dana axle.

If you need any assistance identifying the correct axle unit for your truck and equipment, contact your Dana replacement part specialists at Pro Gear and Transmission.

Pro Gear and Transmission has same day shipping and 1000's of products in stock and ready to ship internationally for your next project.

For parts or service contact the Dana Axle specialists at Pro Gear & Transmission, Inc.

 CALL US

 EMAIL US

 VISIT MODEL PAGE

 VISIT ONLINE STORE

Pro Gear and Transmission, Inc | [www.progearandtransmission.com](http://www.progearandtransmission.com) | [www.pgtruckparts.com](http://www.pgtruckparts.com)  
906 West Gore St, Orlando, FL, 32805 | +1 (877)-776-4600 | +1 (407)-872191 | [parts@eprogear.com](mailto:parts@eprogear.com)



## Illustrated Parts List

---

**AXIP0201**

**September 2006**

DSH40(P), DSH44(P), DDH40(P), DDH44(P),  
RSH40, RSH44, RDH40, RDH44, 22060SH

**IMPORTANT: THE FORWARD MODELS (DSH40(P), DSH44(P), DDH40(P), DDH44(P) DETAILED IN THIS IPL EDITION ARE ONLY PRE JUNE 2008 DESIGNS. CONTACT DANA FOR ANY PARTS & KITS FOR MODELS PRODUCED ON OR AFTER JUNE 2008.**



**TABLE OF CONTENTS**

**Models ..... 2**

**General Information ..... 3**

    How To Use Illustrated Parts List.....3

    Model Identification .....4

**Identification ..... 5**

**Forward Axle Parts Explode ..... 6**

**Forward Axle Parts List ..... 8**

**Wheel Differential Lock Assembly ..... 11**

**Rear Axle Parts Explode ..... 12**

**Rear Axle Parts List ..... 13**

**Bearing Spacers ..... 15**

    DSH40(P), DSH44(P), DDH40(P), DDH44(P) ..... 15

    RSH40, 22060SH, RDH44 ..... 15

**Output Shaft & Axle Housing Parts Explode ..... 16**

**Output Shaft & Axle Housing Parts List ..... 17**

**Carrier Mounting Flange Design Change ..... 18**

    New Axle Housing Fasteners.....18

    Casting & Service Parts Cross-Reference Listing .....20

**Axle Shafts ..... 21**

    Axle Shaft Hardware ..... 22

**Gear & Pinion Kits ..... 23**

**Service Carriers - Single Reduction ..... 25**

    DSH40(P), DSH44(P) ..... 25

    RSH40, 22060SH, RSH44..... 25

    DDH40(P), DDH44(P) ..... 26

    RDH40, RDH44 ..... 26

**Yokes & Flanges ..... 27**

**Oil Seal Installation Tools ..... 28**

**Kits and Assemblies ..... 29**

## Models

The following models are represented in this publication.

### Single Reduction Models

| Forward Axle | Rear Axle | Axle Capacity | Gear Size           |
|--------------|-----------|---------------|---------------------|
| DSH40(P)     | RSH40     | 40,000 Lbs    | 15.675" Hypoid Gear |
| DSH44(P)     | RSH44     | 44,000 Lbs    | 15.675" Hypoid Gear |

### Single Reduction Models W/Wheel Differential Lock

| Forward Axle | Rear Axle | Axle Capacity | Gear Size           |
|--------------|-----------|---------------|---------------------|
| DDH40(P)     | RDH40     | 40,000 Lbs    | 15.675" Hypoid Gear |
| DDH44(P)     | RDH44     | 44,000 Lbs    | 15.675" Hypoid Gear |

### Single Reduction - Single Axle Applications

| Model   | Axle Capacity | Gear Size           |
|---------|---------------|---------------------|
| 22060SH | 40,000 Lbs    | 15.675" Hypoid Gear |

## General Information

### How To Use Illustrated Parts List

#### Ordering Parts

- This parts book is organized in sections according to parts servicing requirements. Use the Contents or page headings and colored tabs to find information.
- Use this book to order parts for your Spicer® Axle.
- For convenience, part numbers have been included for all pieces of the carrier assembly. Some of these parts, such as the carrier and caps, are serviced only in kits or assemblies. Part numbers are for your reference only. Those parts not serviced separately are identified with NSS.

#### Kits and Assemblies

- Kits and Assemblies contain groups of individual or assembled parts developed for optimal replacement or repair of a service problem.
- Kits and Assemblies are shown with applicable parts groupings in the parts listing.
- See the Appendix for detailed information concerning kits applicable to this model.

#### Abbreviations

- **AR - As Required** - Parts that vary in quantity with each axle. Example: shims
- **NSS - Not Serviced Separately** - Items which can only be purchased in sets, kit form or service assemblies. Example: brake shoes.
- **RH/LH - Right Hand/Left Hand** - Determined as viewed from behind the vehicle looking forward.
- **“RTV” - Gasket Compound** - Formed-in-place gasket sealer. It is recommended for use on all surfaces requiring a gasket.
- **Assy - Assembly**

- **Brg - Bearing**
- **Diff - Differential**
- **Hsg - Housing**
- **Inv- Involute**
- **IASS - In Axle Speed Sensor**
- **ABS - Antilock Brake System**
- **N/A - Not Applicable**
- **Str- Straight**

#### Illustrations

- Illustrations show parts in assembly groups.
- Item numbers on illustrations correspond with parts listings on pages that accompany the drawings.
- Notes are included on illustrations where needed.

#### Parts Listings

- Parts listings are defined by parts groupings and are broken down by service assemblies.
- Parts Listings identify a part for servicing with the following categories:
  - **Item** - corresponds with numbers on illustrations for part identification
  - **Description** - specifies part name or description
  - **Quantity (Qty)** - quantity required for assembly
  - **Current Part** - service part numbers are broken down by model, type or other applicable information
  - **Notes** - define unique characteristics or replacement notes
  - **Kits / Assy's Where Used** - indicates Kits or Assemblies that contain a particular part
- **Other pertinent information is listed in tables or parts listings as required.**

### Effectively Using a Parts Listing—Example

- Follow the example below to locate and order exactly what is required for servicing.

| Match to items on illustration | Use to identify Part  | Order this quantity for servicing | Order Part Number by Model indicated |                      | Indicates information important to ordering or use |
|--------------------------------|-----------------------|-----------------------------------|--------------------------------------|----------------------|--|
| Item                           | Description           | Qty                               | DSH40(P)<br>DSH44(P)                 | DDH40(P)<br>DDH44(P) | Notes  |
| 7                              | Brg Cup - Plain Half  | 1                                 | 129566 •                             | 015092 •             |  |
| 8                              | Brg Cone - Plain Half | 1                                 | 129565 •                             | 128604 •             |  |

#### Summary of Kits and Assemblies

| Item | Description         | DSH40(P)<br>DSH44(P) | DDH40(P)<br>DDH44(P) | Notes                      |
|------|---------------------|----------------------|----------------------|----------------------------|
|      | OIL SEAL & SHIM KIT | 216224               | 216224               | Includes 49-54 & 127592    |
|      | BASIC OVERHAUL KIT  | 510393               | 510393               | Contents Identified with • |

## Model Identification

### Locating Model Designation Information

- Axle Model Identification, Part Number and Serial Number are located on a tag at the axle centerline. This information will help to locate information in this book and to identify the correct parts for servicing.

### Drive Axles



- **Model Number, Part Number and Serial Number** are located on the data plate on the axle centerline

### Drive Axle Assembly Tag

1. The OEM part number assigned to the axle build.
2. The specification number assigned to the axle build by Spicer. The spec number will identify all the component parts of the axle as built by Spicer, including special OEM requirements such as yokes or flanges.
3. The axle model identification.
4. The production or service part number of the carrier assembly.
5. The gear ratio of the axle.
6. The serial number of the carrier assembly assigned by the manufacturing plant.

**Note:** When inquiring about specific information on your axle, write down all of the above information from your tag and call your local OEM dealer or your Dana representative.

7. Country of Origin

- The axles illustrated in this book are specified with a variety of different axle shafts, according to OEM specifications. **When ordering replacement axle shafts, note the part number stamped into the flange.**



## Using Model Designation to Identify Axle Components

- The Axle Model Identification number contains information that is important to understand when purchasing service parts or new components. The Model Identification number provides important vehicle, capacity and application information and model features. Use this guideline to understand your Axle Model Identification. If you need assistance, contact your Dana representative.





Forward Axle Parts Explode

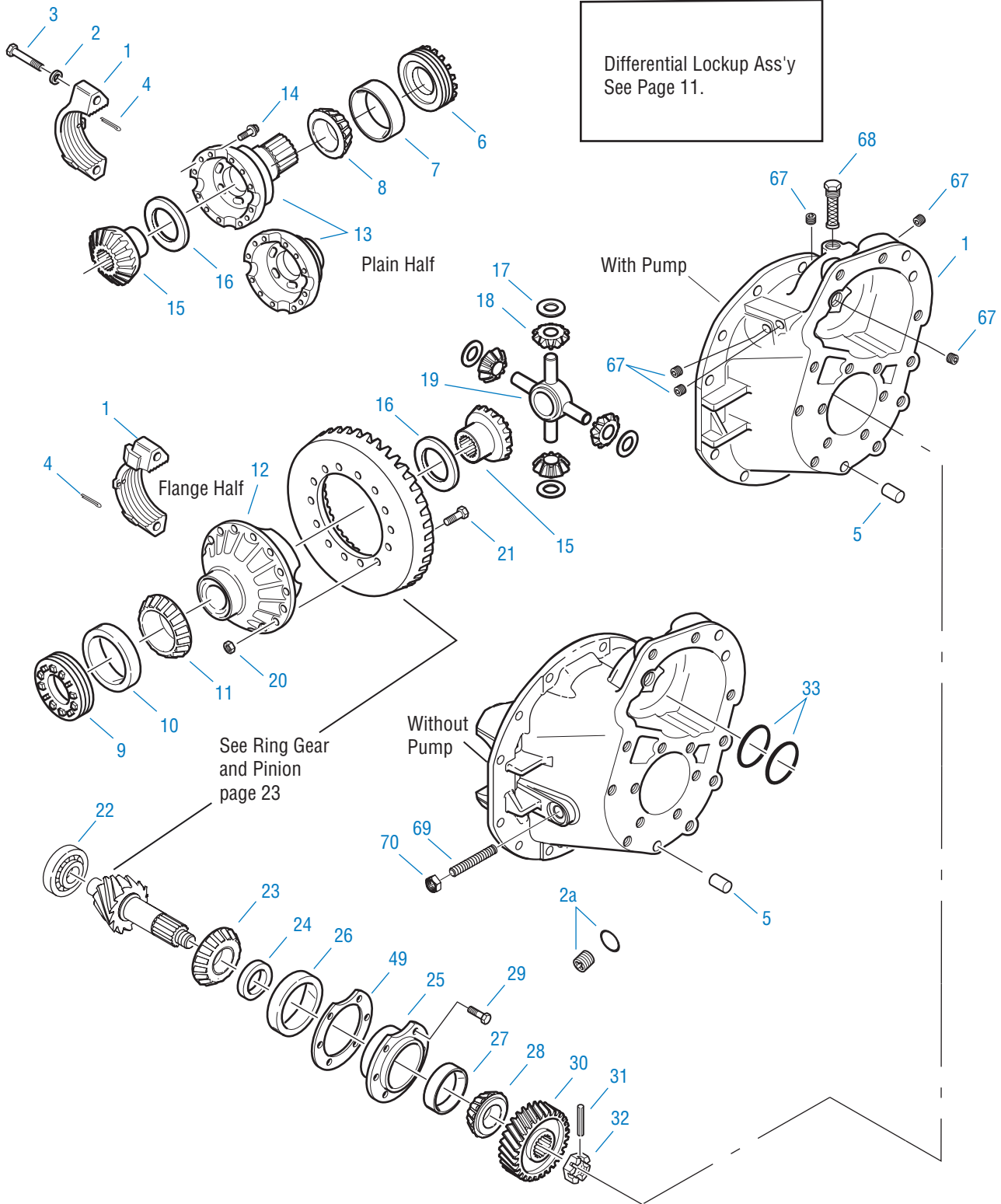

# Forward Axle Parts Explode

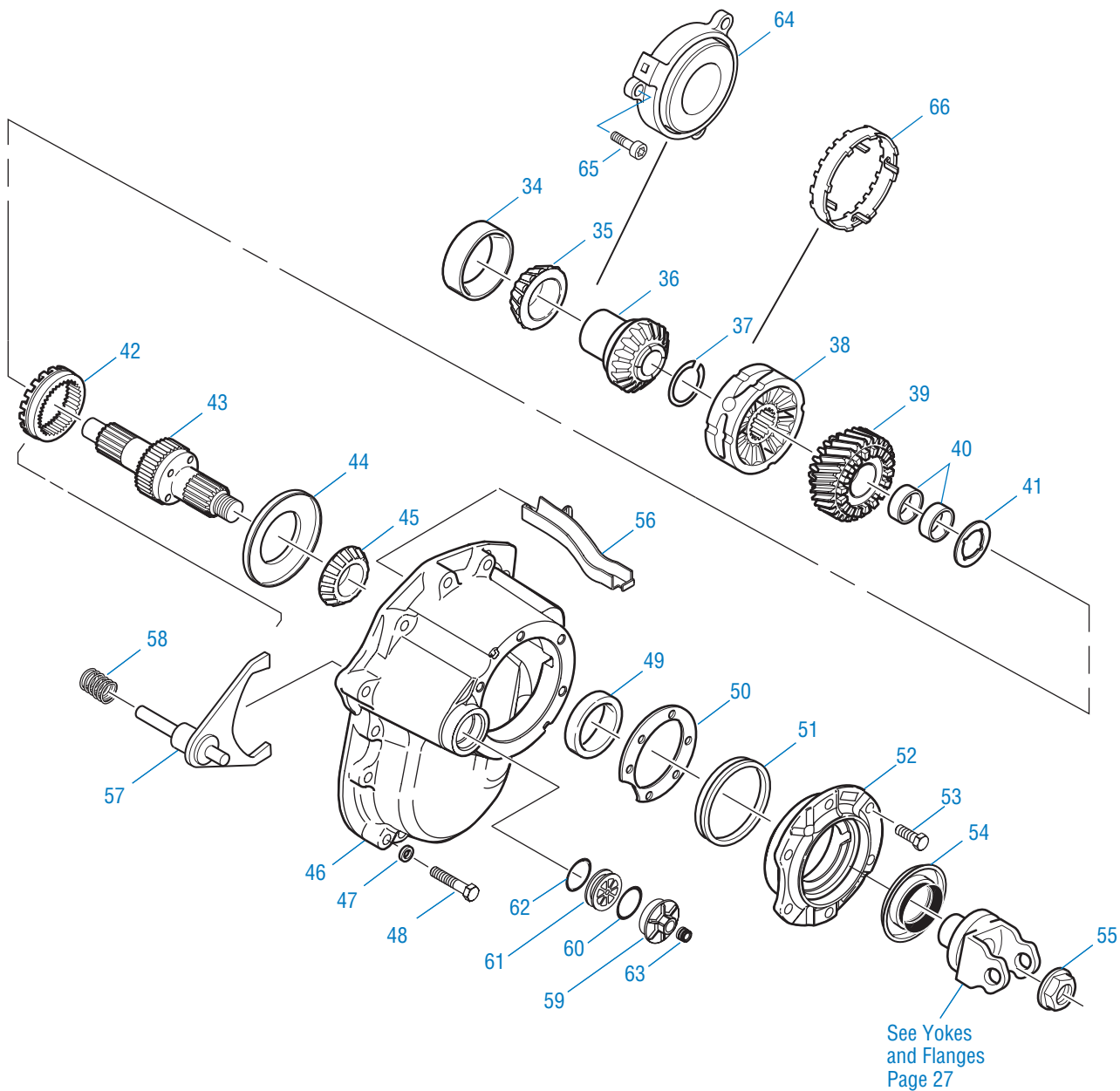

## Forward Axle Parts List

| Item | Part Name                           | Qty | DSH40(P)<br>DSH44(P) | DDH40(P)<br>DDH44(P) | Remarks   |
|------|-------------------------------------|-----|----------------------|----------------------|---|
|      | BASIC OVERHAUL KIT                  |     | 510393               | 510399               | Contents Identified with •  |
|      | BEARING KIT                         |     | 512812               | 512800               |   |
| 1    | DIFF CARRIER & BEARING CAPS KIT     |     |                      |                      | Includes Items 1-3, 5, 67, 69-71 and Items 8-11 on p.17, See Note 1 |
|      | DSH40                               |     | 510023               | -                    | Casting #130809   |
|      | DSH40P                              |     | 510024               | -                    | Casting #130819   |
|      | DDH40                               |     | -                    | 510027               | Casting #130814   |
|      | DDH40P                              |     | -                    | 510028               | Casting #130814   |
| 2    | Flat Washer                         | 4   | 210288               | 210288               |   |
| 2a   | Plug & O-ring Assembly              | 1   | 131809               | 131809               | O-ring not serviced seperately                                      |
| 3    | Capscrew                            | 4   | 210095               | 210095               |   |
| 4    | Cotter Pin                          | 2   | 090873               | 090873               |   |
| 5    | Dowel Pin                           | 2   | 007641               | 007641               |   |
| 6    | Diff Brg Adjuster - Plain Half      | 1   | 129130               | 128616               |   |
| 7    | Brg Cup - Plain Half                | 1   | 129566 •             | 015092 •             |   |
| 8    | Brg Cone - Plain Half               | 1   | 129565 •             | 128604 •             |   |
| 9    | Diff Brg Adjuster - Flange Half     | 1   | 129128               | 129128               |   |
| 10   | Brg Cup - Flange Half               | 1   | 129564 •             | 129564 •             |   |
| 11   | Brg Cone - Flange Half              | 1   | 129563 •             | 129563 •             |   |
|      | WHEEL DIFF CASE KITS                |     |                      |                      | Includes items 12-14  |
| 12   | Diff Case-RH (Flg Half) - NSS129464 | 1   | 508653               | 508724               | Ratios 3.08 to 3.55   |
|      | NSS129465                           |     | 508654               | 508725               | Ratios 3.70 to 4.11   |
|      | NSS129466                           |     | 508655               | 508726               | Ratios 4.33 to 4.88   |
|      | NSS129467                           |     | 508656               | 508727               | Ratios 5.29 to 7.17   |
| 13   | Diff Case-LH (Plain Half)-NSS       | 1   | 127498               | 128607               | Order kits listed above   |
| 14   | Capscrew                            | 12  | 127465               | 128619               |   |

**Note 1:** On June 3, 2002, the design of carrier mounting flange of the DSH40(P), DSH44(P), DDH40(P), DDH44(P) and RSH40, RSH44, 22060SH, RDH40 and RDH44 models changed. The new carrier's are designed with a "Thick Flange". Carriers designed with a "Thick Flange" require the use of "long" capscrews. The fastening hardware for these models can be found on pages 16-18 of this IPL. Refer to Spicer bulletin ABIB-0210R1 for further details.

## Forward Axle Parts List

| Item | Part Name  | Qty | DSH40(P)<br>DSH44(P) | DDH40(P)<br>DDH44(P) | Remarks                                      |
|------|--|-----|----------------------|----------------------|--|
|      | WHEEL DIFF SIDE GEAR KIT   |     | 510397               | 510397               | Includes items 15-19                         |
|      | WHEEL DIFF KIT w/o SIDE GEARS  |     | 510396               | 510396               | Includes items 16-19                         |
| 15   | Side Gear 41 Inv spline  | 2   | 127368               | 127368               |  |
| 16   | Side Gear Thrust Washer  | 2   | 127386 •             | 127386 •             |  |
| 17   | Side Pinion Thrust Washer  | 4   | 129305 •             | 129305 •             |  |
| 18   | Side Pinion  | 4   | 129765               | 129765               |  |
| 19   | Diff Spider  | 1   | 129599               | 129599               |  |
|      | RING GEAR NUT & BOLT KIT   |     | 508652               | 508652               | Includes items 20-21                         |
| 20   | Nut  | 16  | 126216               | 126216               |  |
| 21   | Bolt   | 16  | 129686               | 129686               |  |
| 22   | Pinion Pilot Brg   | 1   | 127484 •             | 127484 •             |  |
| 23   | Pinion Brg Cone - Inner  | 1   | 129560 •             | 129560 •             |  |
| 24   | Pinion Brg Spacer  | AR  |                      |                      | Pinion Bearing Spacer pg. 15                 |
| 25   | Pinion Brg Cage & Cup Assy<br>Cage #127488C NSS                      | 1   | 129767               | 129767               | Includes item 25-27                          |
| 26   | Pinion Brg Cup - Inner   | 1   | 129561 •             | 129561 •             |  |
| 27   | Pinion Brg Cup - Outer   | 1   | 012495 •             | 012495 •             |  |
| 28   | Pinion Brg Cone - Outer  | 1   | 127535 •             | 127535 •             |  |
| 29   | Capscrew   | 6   | 210115               | 210115               |  |
| 30   | Pinion Helical Gear  | 1   | 127523               | 127523               |  |
| 31   | Roll Pin   | 1   | 118807               | 118807               |  |
| 32   | Slotted Pinion Nut   | 1   | 126182               | 126182               |  |
| 33   | Output Shaft O-Ring  | 2   | 127545 •             | 127545 •             |  |
| 34   | Output Shaft Brg Cup   | 1   | 127536 •             | 127536 •             |  |
| 35   | Output Shaft Brg Cone  | 1   | 110812 •             | 110812 •             |  |
| 36   | Output Shaft Side Gear   | 1   | 127645               | 127645               |  |
| 37   | Snap Ring  | 1   | 085997 •             | 085997 •             |  |
| 38   | Inter-Axle Diff Assy   | 1   | 129771               | 129771               | Replaces 128634                              |
| 39   | Helical Side Gear & Bushing Assy<br>Gear #130906 NSS (Incls item 40) | 1   | 130907               | 130907               | Replaces 127495                              |
| 40   | Helical Gear Bushing   | 2   | 129371               | 129371               | Replaces 127543                              |
| 41   | Helical Gear Thrust Washer   | 1   | 128702 •             | 128702 •             |  |
| 42   | Lockout Sliding Clutch   | 1   | 127510               | 127510               |  |
| 43   | INPUT SHAFT KIT<br>Input Shaft 129770 NSS                            | 1   | 510593               | 510593               | Includes Items 41, 43, 55<br>Replaces 510394 |
| 44   | Oil Retainer   | 1   | 128700 •             | 128700 •             |  |

## Forward Axle Parts List

| Item | Part Name   | Qty | DSH40(P)<br>DSH44(P)   | DDH40(P)<br>DDH44(P)   | Remarks   |
|------|---|-----|------------------------|------------------------|---|
| 45   | Input Shaft Bearing Cone                                | 1   | 129558 •               | 129558 •               | Replaces 820643   |
| 46   | PDU Cover   | 1   | 130823                 | 130823                 | See Note 2<br>Replaced 129572   |
| 46A  | Magnet  | 1   | 129494                 | 129494                 | Not Illustrated, located inside PDU Cover                             |
| 47   | Washer  | 11  | 128415                 | 128415                 |   |
| 48   | Capscrew Long   | 11  | 210091                 | 210091                 | See Note 2  |
| 49   | Bearing Cup   | 1   | 129559                 | 129559                 | Optional Part No. 1008912   |
|      | <a href="#">OIL SEAL &amp; SHIM KIT</a>                 | 1   | <a href="#">216224</a> | <a href="#">216224</a> | <a href="#">Includes items 50, 54 &amp; 127592 (item 17 on p. 17)</a> |
| 50   | Shim.003  | AR  | 127595 •               | 127595 •               |   |
|      | Shim.005  |     | 127596 •               | 127596 •               |   |
|      | Shim.010  |     | 127597 •               | 127597 •               |   |
|      | Shim.020  |     | 127598 •               | 127598 •               |   |
|      | Shim.030  |     | 127599 •               | 127599 •               |   |
| 51   | Oil Seal-V-Ring   | 1   | 128703 •               | 128703 •               |   |
| 52   | Input Brg Cover Assy - #129574C                         | 1   | 129766                 | 129766                 | Includes item 49  |
| 53   | Bearing Cover Cap Screw                                 | 6   | 210115                 | 210115                 |   |
| 54   | Oil Seal  | 1   | 127591 •               | 127591 •               |   |
| 55   | Locknut   | 1   | 128049                 | 128049                 | In 510394 Kit (M42x1.5)   |
| 56   | Lube Trough   | 1   | 129577                 | 129577                 |   |
|      | <a href="#">AIR LOCKOUT KIT - COMPLETE</a>              | 1   | <a href="#">510052</a> | <a href="#">510052</a> | <a href="#">Includes items 57- 59, 61- 62</a>                         |
|      | <a href="#">AIR LOCKOUT REPAIR KIT</a>                  | 1   | <a href="#">510053</a> | <a href="#">510053</a> | <a href="#">Includes items 59, 61- 62</a>                             |
| 57   | Shift Fork Assy - NSS                                   | 1   | 129856                 | 129856                 | Order Kit 510870  |
| 58   | Compression Spring                                      | 1   | 129859                 | 129859                 |   |
|      | <a href="#">SHIFT FORK &amp; COMPRESSION SPRING KIT</a> | 1   | <a href="#">510870</a> | <a href="#">510870</a> | <a href="#">Includes items 57 &amp; 58</a>                            |
| 59   | Piston Cover Assy                                       | 1   | 129573                 | 129573                 | Includes Cover #129578 & Item 60                                      |
| 60   | O-Ring  | 1   | 129579                 | 129579                 |   |
| 61   | Piston  | 1   | 129580                 | 129580                 |   |
| 62   | O-Ring  | 1   | 210180                 | 210180                 |   |
| 63   | Shipping Plug   | 1   | 599792                 | 599792                 |   |
| 64   | Lube Pump Assembly                                      | 1   | 127534                 | 127534                 | Pump Models Only  |
| 65   | Capscrew  | 3   | 127551                 | 127551                 | Pump Models Only  |
| 66   | Drive Coupling - Service                                | 1   | 128628                 | 128628                 | Pump Models Only  |
| 67   | Pipe Plug   | 5   | 090897                 | 090897                 | Pump Models Only  |
| 68   | Filter Screen Assy                                      | 1   | 127649                 | 127649                 | Pump Models Only  |
| 69   | Thrust Screw  | 1   | 126193                 | 126193                 |   |
| 70   | Jam Nut   | 1   | 210184                 | 210184                 |   |
| 71   | RTV - Sealant   | 1   | 107276S •              | 107276S •              | Not Illustrated   |

**Note 2:** On June 3, 2002, the design of the power divider cover changed. The original PDU covers (P/N: 129572) have 9 holes and require 9 fasteners. The current design PDU covers (P/N: 130823) have 11 holes and require the use of 11 long fasteners. The new 130823 PDU covers now replace the 129572 covers in service.

- The 9-hole PDU cover will NOT work on a carrier machined with 11 holes.
- A new 11-hole PDU cover will adapt to a 9-hole carrier without modifications. Refer to Spicer bulletin ABIB-0210 for further details.

## Wheel Differential Lock Assembly



Rear carrier illustrated above. Parts for forward carrier are identical to the rear carrier.

| Item | Part Name                             | Qty | DDH40(P)<br>DDH44(P)<br>RDH40<br>RDH44 | Remarks                   |
|------|---------------------------------------|-----|--|---------------------------|
| 1    | Fixed Curvic Clutch Gear              | 1   | 128627                                 |                           |
| 2    | Snap Ring                             | 1   | 129433                                 |                           |
| 3    | SL Curvic Clutch Gear - 41 Inv spline | 1   | 126840                                 |                           |
| 4    | Compression Spring                    | 1   | 128614                                 |                           |
|      | <b>SHIFT FORK ASSY</b>                |     | <b>217465</b>                          | <b>Includes items 5-6</b> |
| 5    | Shift Fork - NSS                      | 1   | 128609                                 |                           |
| 6    | Spring Pin                            | 1   | 210020                                 |                           |
| 7    | Push Rod                              | 1   | 128617                                 |                           |
| 8    | Piston Driver                         | 1   | 128640                                 |                           |
| 9    | Set Screw                             | 1   | 128618                                 |                           |
| 10   | Piston                                | 1   | 128624                                 |                           |
| 11   | O-Ring                                | 1   | 210180                                 |                           |
| 12   | Piston Cover                          | 1   | 129425                                 |                           |
| 13   | Gasket                                | 1   | 128643                                 |                           |
| 14   | Capscrew - Flg Head                   | 2   | 128744                                 |                           |
| 15   | Capscrew                              | 1   | 129946                                 |                           |
| 16   | Washer                                | 1   | 129034                                 |                           |
| 17   | Switch                                | 1   | 129035                                 |                           |
| 18   | Wiring Harness                        | 1   | 129047                                 | Not Illustrated           |
| 19   | Washer                                | 1   | 210288                                 | Not Illustrated, Note 1   |

# Rear Axle Parts Explode

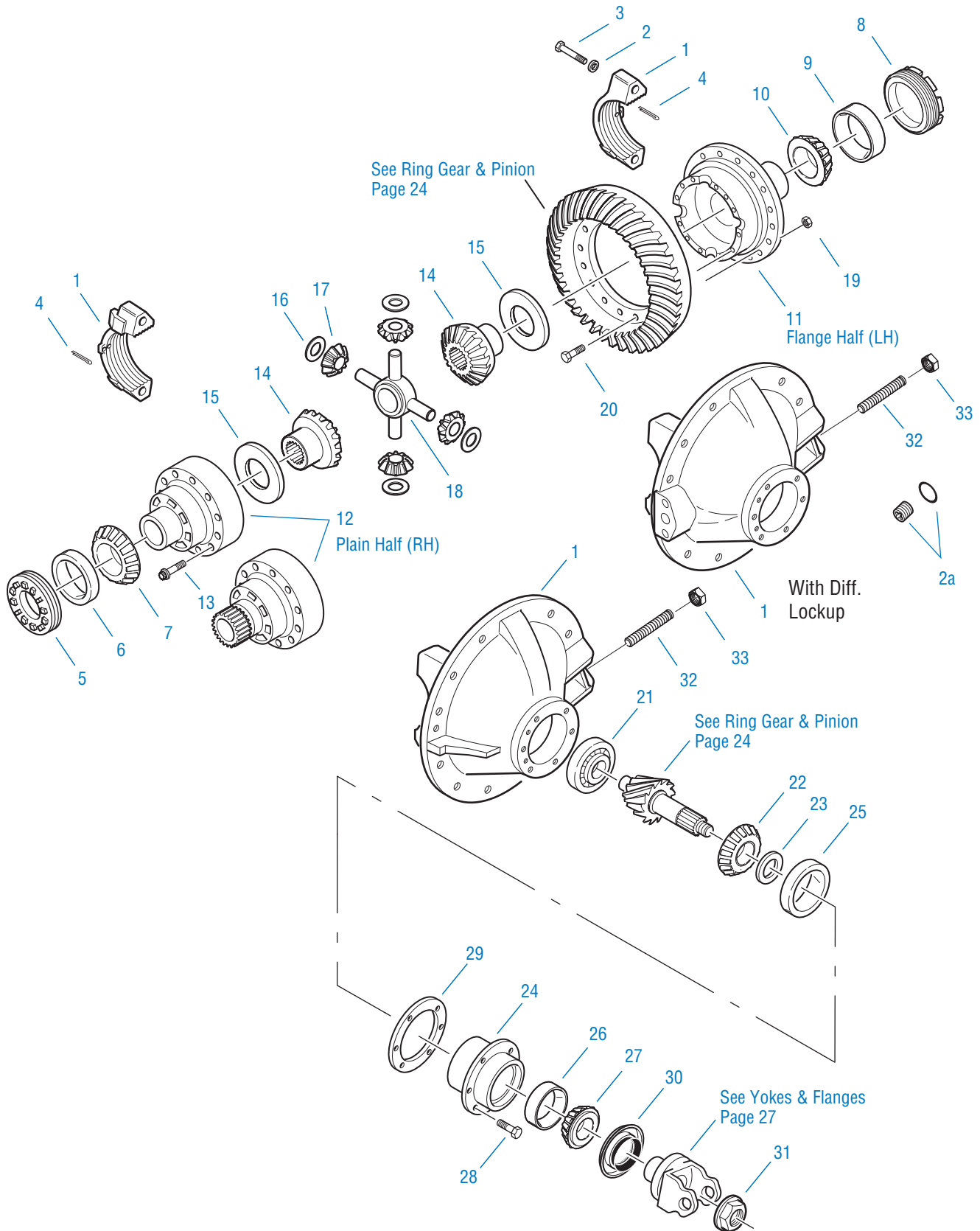

## Rear Axle Parts List

| Item | Part Name   | Qty | RSH40<br>RSH44<br>22060SH | RDH40<br>RDH44 | Remarks                        |
|------|---|-----|---------------------------|----------------|--------------------------------|
|      | BASIC OVERHAUL KIT                                |     | 510398                    | 510400         | Contents Identified with •     |
|      | BEARING KIT                                       |     | 512806                    | 512805         |                                |
| 1    | DIFF CARR & BRG CAPS KIT                          |     |                           |                |                                |
|      | Includes items 1-3, 33-34 and items 8-11 on p. 17 |     | 510018                    | -              | Casting # 130824<br>See Note 1 |
|      |   |     | -                         | 510017         | Casting # 130827               |
| 2    | Flat Washer                                       | 4   | 210288                    | 210288         |                                |
| 2a   | Plug & O-ring Assembly                            | 1   | 131809                    | 131809         | O-ring not serviced seperately |
| 3    | Capscrew  | 4   | 210095                    | 210095         |                                |
| 4    | Cotter Pin  | 2   | 090873                    | 090873         |                                |
| 5    | Diff Brg Adjuster - Plain Half                    | 1   | 129130                    | 128616         |                                |
| 6    | Bearing Cup - Plain Half                          | 1   | 129566 •                  | 015092 •       |                                |
| 7    | Bearing Cone - Plain Half                         | 1   | 129565 •                  | 128604 •       |                                |
| 8    | Diff Brg Adjuster - Flange Half                   | 1   | 129128                    | 129128         |                                |
| 9    | Bearing Cup - Flange Half                         | 1   | 129564 •                  | 129564 •       |                                |
| 10   | Bearing Cone - Flange Half                        | 1   | 129563 •                  | 129563 •       |                                |
|      | WHEEL DIFF. CASE KITS                             |     |                           |                | Includes items 11-13           |
| 11   | Diff Case-LH (Flg Half) - NSS129464               | 1   | 508653                    | 508724         | Ratios 3.08 to 3.55            |
|      | NSS129465   |     | 508654                    | 508725         | Ratios 3.70 to 4.11            |
|      | NSS129466   |     | 508655                    | 508726         | Ratios 4.33 to 4.88            |
|      | NSS129467   |     | 508656                    | 508727         | Ratios 5.29 to 7.17            |
| 12   | Diff Case-RH(Plain Half)-NSS                      | 1   | 127498                    | 128607         | Order kits listed above        |
| 13   | Capscrew  | 12  | 127465                    | 128619         |                                |
|      | WHEEL DIFF SIDE GEAR KIT                          |     | 510397                    | 510397         | Includes items 14-18           |
|      | WHEEL DIFF KIT w/o SIDE GEARS                     |     | 510396                    | 510396         | Includes items 15-18           |
| 14   | Side Gear 41 Inv spline                           | 2   | 127368                    | 127368         |                                |
| 15   | Side Gear Thrust Washer                           | 2   | 127386 •                  | 127386 •       |                                |
| 16   | Side Pinion Thrust Washer                         | 4   | 129305 •                  | 129305 •       |                                |
| 17   | Side Pinion                                       | 4   | 129765                    | 129765         |                                |
| 18   | Diff Spider                                       | 1   | 129599                    | 129599         |                                |

**Note 1:** On June 3, 2002, the design of carrier mounting flange of the DSH40(P), DSH44(P), DDH40(P), DDH44(P) and RSH40, RSH44, 22060SH, RDH40 and RDH44 models changed. The new carrier's are designed with a "Thick Flange". Carriers designed with a "Thick Flange" require the use of "long" capscrews. The fastening hardware for these models can be found on pages 16-18 of this IPL. Refer to Spicer bulletin ABIB-0210R1 for further details.



## Rear Axle Parts List

| Item | Part Name                                       | Qty | RSH40<br>RSH44<br>22060SH | RDH40<br>RDH44 | Remarks                         |
|------|---|-----|---------------------------|----------------|---------------------------------|
|      | <b>RING GEAR NUT &amp; BOLT KIT</b>             |     | <b>508652</b>             | <b>508652</b>  | <b>Includes items 19-20</b>     |
| 19   | Nut   | 16  | 126216                    | 126216         |                                 |
| 20   | Bolt  | 16  | 129686                    | 129686         |                                 |
| 21   | Pinion Pilot Brg                                | 1   | 127485 •                  | 127485 •       |                                 |
| 22   | Pinion Brg Cone - Inner                         | 1   | 129562 •                  | 129562 •       |                                 |
| 23   | Pinion Brg Spacer                               | AR  |                           |                | Pinion Bearing Spacer pg. 15    |
| 24   | Pinion Brg Cage & Cup Assy<br>Cage #127481C NSS | 1   | 129768                    | 129768         | Includes items 24-26            |
| 25   | Pinion Brg Cup - Inner                          | 1   | 129561 •                  | 129561 •       |                                 |
| 26   | Pinion Brg Cup - Outer                          | 1   | 012495 •                  | 012495 •       |                                 |
| 27   | Pinion Brg Cone - Outer                         | 1   | 012496 •                  | 012496 •       |                                 |
| 28   | Capscrew  | 6   | 210115                    | 210115         |                                 |
|      | <b>OIL SEAL &amp; SHIM KIT</b>                  |     | <b>216225</b>             | <b>216225</b>  | <b>Includes items 29-30, 34</b> |
| 29   | Shim.003  | AR  | 127595 •                  | 127595 •       |                                 |
|      | Shim.005  |     | 127596 •                  | 127596 •       |                                 |
|      | Shim.010  |     | 127597 •                  | 127597 •       |                                 |
|      | Shim.020  |     | 127598 •                  | 127598 •       |                                 |
|      | Shim.030  |     | 127599 •                  | 127599 •       |                                 |
| 30   | Oil Seal  | 1   | 127591 •                  | 127591 •       |                                 |
| 31   | Pinion Nut                                      | 1   | 127589                    | 127589         | M36 x 1.5                       |
| 32   | Thrust Screw                                    | 1   | 126193                    | 126193         |                                 |
| 33   | Jam Nut   | 1   | 210184                    | 210184         |                                 |
| 34   | RTV - Sealant                                   | 1   | 107276S •                 | 107276S •      | Not Illustrated                 |

NSS - Not Sold Separately

## Bearing Spacers

### DSH40(P), DDH40 (P)

| Part Number | Spacer Thickness |
|-------------|------------------|
| 129079      | .797             |
| 129080      | .798             |
| 129081      | .800             |
| 129082      | .801             |
| 129083      | .802             |
| 129084      | .803             |
| 129085      | .804             |
| 129086      | .806             |
| 129087      | .807             |
| 129088      | .808             |
| 129089      | .809*            |
| 129090      | .810*            |
| 129091      | .811*            |
| 129093      | .812*            |
| 129097      | .814*            |
| 129099      | .815*            |
| 129101      | .816*            |
| 129103      | .817*            |
| 129105      | .818*            |
| 129107      | .819*            |
| 129109      | .820*            |
| 129111      | .821             |
| 129113      | .822             |
| 129115      | .823             |
| 129117      | .824             |
| 129119      | .825             |
| 129120      | .826             |
| 129121      | .828             |
| 129122      | .829             |
| 129123      | .830             |
| 129124      | .831             |
| 129125      | .832             |
| 129126      | .833             |

\* Most Popular

### RSH40, RDH40

| Part Number | Spacer Thickness |
|-------------|------------------|
| 91552       | .623             |
| 91553       | .624             |
| 91554       | .625             |
| 91555       | .626             |
| 91556       | .627             |
| 91557       | .628             |
| 91558       | .629             |
| 91559       | .630             |
| 91560       | .631             |
| 91561       | .632             |
| 91562       | .633             |
| 91564       | .634*            |
| 91566       | .635*            |
| 91568       | .636*            |
| 91572       | .637*            |
| 91576       | .638*            |
| 91580       | .639*            |
| 91584       | .640*            |
| 91588       | .641*            |
| 91592       | .642*            |
| 91596       | .643*            |
| 91600       | .644*            |
| 91602       | .645             |
| 91604       | .646             |
| 91606       | .647             |
| 91608       | .648             |
| 91610       | .649             |
| 91611       | .650             |
| 91612       | .651             |
| 91613       | .652             |
| 91614       | .653             |
| 91615       | .654             |

\* Most Popular

## Output Shaft & Axle Housing Parts Explode



## Output Shaft & Axle Housing Parts List

| Item  | Part Name                    | Qty      | Part Number   | Remarks   |
|-------|------------------------------|----------|---------------|---|
| 1     | Outer Bearing Adjuster Nut   | 2        | 119881        |   |
| 2     | Lockwasher - w/Tab           | 2        | 129132        |   |
| 3     | Dowel-Type Lockwasher        | 2        | 119883        |   |
| 4     | Inner Bearing Adjuster Nut   | 2        | 119882        |   |
| 5     | Axle Housing Assy            | 1        |               | See your OEM Catalog                            |
| 6     | U-Tube Breather Kit          | 1        | 507162        |   |
| 7     | Magnetic Drain Plug - 3/4"   | 1        | 054254        | All D/R models                                  |
| 8 -11 | Carrier to Hsg Fasteners     |          |               | See Page 19                                     |
| 12    | Non-Magnetic Plug 3/4"       | 1        | 129492        |   |
| 12    | Magnetic Plug - 3/4"         | 1        | 129491        |   |
| 13    | Temperature Sensor Plug 1/2" | 1        | 90898         |   |
| 14    | Lube Tag (for 3/4" Plug)     | 1        | 129486        | Part - Not Illustrated                          |
|       | <b>OUTPUT SHAFT KIT</b>      | <b>1</b> | <b>216227</b> | <b>Includes Items 15-16<br/>Replaces 510395</b> |
| 15    | Output Shaft - #127646 NSS   |          |               |   |
| 16    | Locknut - Hex                | 1        | 127588        | M39 x 1.5                                       |
| 17    | Oil Seal                     | 1        | 127592 •      |   |
| 18    | Snap Ring .103"              | 1        | 129594 •      |   |
| 19    | Bearing Cup                  | 2        | 127539 •      |   |
| 20    | Bearing Cone                 | 2        | 127540 •      |   |
| 21    | Seal Driver                  | 1        | 126917        | In Kit 217414 - See Page 28                     |
| 22    | Adapter                      | 1        | 128706        | In Kit 217414 - See Page 28                     |
| 23    | Loctite Adhesive             | 1        | 129293        | Not Illustrated, .5 ml Tube                     |
| 24    | RTV - Sealant                | 1        | 107276S •     | Not Illustrated, 3 oz. Tube                     |

• Included in Bearing & Basic Overhaul Kits

NSS - Not Sold Separately

## Carrier Mounting Flange Design Change

Beginning June 3rd, 2002, the nominal thickness of the carrier to housing flange was increased in the DSH40(P), DSH44(P), DDH40(P), DDH44(P) and RSH40, RSH44, 22060SH, RDH40 and RDH44 models. This change required the use of new fastener parts. A new (45mm) capscrew (P/N 130836) was released as it replaced both 210173 and 130158 old design capscrews. Additionally, a much thicker boss was added to the flange at the 12:00 & 6:00 o'clock positions. These new thicker flange bosses require an even longer (70mm) capscrew (P/N 130837). A thicker and larger diameter flat washer (P/N 130877) was also released as part of this upgrade. The new washer replaces existing washer 29804. The existing stud (P/N 127641) and nut (P/N 127567) are not affected by these changes and will continue to be used.

### SERVICE CARRIER NOTE:

Stock levels of both early design service carriers and new "Thick Flange" design service carriers exist. If you have a vehicle that was originally equipped with a Spicer axle built with the "Thick Flange" carrier design, it can be universally serviced with an early style (Thin Flange) Service Carrier. The repairing dealer must simply make sure to use the correct axle housing hardware parts when installation is done. New service carriers built with the thick flange design, will include the necessary thick flange hardware kit to minimize any down time to the customer.

- Differentials with "THICK FLANGE" carriers use axle housing hardware kit (P/N 512087).
- Early design differentials with "THIN FLANGE" carriers use axle housing hardware kit (P/N 511600).
- GM Vehicles requires the use of double-ended capscrews at the housing fastener location. Double-ended capscrews for thick flange design carriers are not available at this time. GM vehicles must be serviced with early design carriers, available only through GM.

### New Axle Housing Fasteners



### IMPORTANT!

Spicer does not recommend the mixing of various designs carrier-to-housing capscrews on the same assembly. Whether mixing or not, torques must be measured using a calibrated torque wrench.

Failure to re-torque bolts and nuts to proper specifications may lead to carrier to housing leaks and possible component damage.

## Axle Housing Fasteners

On June 3, 2002 the DSP40(P), DSP 41(P), DDP40(P), DDP41(P), RSP40, RSP41, RDP40 and RDP41 models were upgraded to the new "Thick Flange" carrier design as fully detailed in Spicer bulletin AXIP-0210R1. Shown below are the axle housing hardware kits and fastener locations for both variations. View fastener locations as if installing differential into the axle housing.

**Thick Flange – After 6/3/02**



**Original Design Flange – Before 6/3/02\***

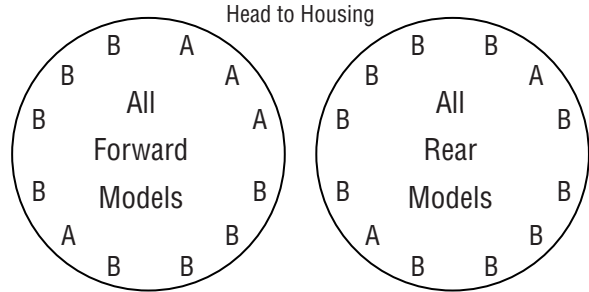

Note: GM models require a special double-ended capscrews. They continue to use carriers with the original design thin flange. At this time Spicer does not have a double-ended capscrew for "Thick Flange" models.

- A – 127641 Studs & 127567 Nuts
- B – 130836 Capscrews – Short (45 mm)
- C – 130837 Capscrews – Long (70 mm)
- D – 130877 Flat Washers – All Locations

### 512087 Hardware Kit (Thick Flange)

| Part No. | Qty. | Description                      |
|----------|------|----------------------------------|
| 107276S  | 1    | RTV Sealant 3 oz. Tube           |
| 127567   | 4    | Nut                              |
| 127641   | 4    | Stud                             |
| 129293   | 1    | Loctite 271 0.5 ml. Tube         |
| 130836   | 8    | Capscrew (45 mm) - Short         |
| 130837   | 4    | Capscrew (70 mm) - Long          |
| 130877   | 12   | Washer                           |
| SHAIS136 | 1    | Instruction Sheet - Thick Flange |

### 511600 Hardware Kit

| Part No. | Qty. | Description              |
|----------|------|--------------------------|
| 107276S  | 1    | RTV Sealant 3 oz. Tube   |
| 127567   | 4    | Nut                      |
| 127641   | 4    | Stud                     |
| 129293   | 1    | Loctite 271 0.5 ml. Tube |
| 130836   | 10   | Capscrew (was 130158)    |
| 130877   | 12   | Washer (was 29804)       |
| SHAIS131 | 1    | Instruction Sheet        |

## Casting & Service Parts Cross-Reference Listing

Below are two helpful cross-reference charts. Chart-A shows "casting" numbers that can quickly identify the old design parts versus the new design parts. Chart-B is a "service parts" cross-reference listing. The part numbers in this chart are sorted by part type; refer to the "New Part Description" column.

### Chart A: Part Number Cross-Reference - Casting Numbers

| New Casting Part No. | Old Casting Part No. | Description           | Model                              |
|----------------------|----------------------|-----------------------|------------------------------------|
| 130809               | 129539, 129540       | Diff. Carrier Casting | DSP40, DSP 41                      |
| 130814*              | 129550               | Diff. Carrier Casting | DDP40, DDP40-P, DDP41, DDP41-P     |
| 130819*              | 129551               | Diff. Carrier Casting | DSP40-P, DSP 41-P                  |
| 130822               | 129571               | PDU Cover Casting     | All "D" Forward Carriers - 11 hole |
| 130824               | 129351C, 129541      | Diff. Carrier Casting | RSP40, RSP41                       |
| 130827*              | 128600               | Diff. Carrier Casting | RDP40, RDP41                       |

\* New Thick Flange Carriers not in production yet, production to start 1st quarter 2003.

### Chart B: Part Number Cross-Reference - Service Parts

| Current Service Part No. | Replaces Old Service Part No. | New Part Description                        | Notes   |
|--------------------------|-------------------------------|---|---|
| 511600                   | None                          | Axle Hsg hardware Kit - Thin Flange Models  | Use only in Models with Thin Flange Carrier Design            |
| 512087                   | None                          | Axle Hsg hardware Kit - Thick Flange Models | Use only in Models with Thick Flange Carrier Design           |
| 130836                   | 130158, 210173                | Capscrew - 45 mm                            | Use in All Models (New & Old Design)                          |
| 130837                   | None                          | Capscrew - 70 mm                            | Use only in Models with Thick Flange Carrier Design           |
| 130158                   | NLA                           | Capscrew - 40 mm                            | Replaced by 130836 Capscrew                                   |
| 210173                   | NLA                           | Capscrew - 40 mm                            | Replaced by 130836 Capscrew                                   |
| 130877                   | 29804*                        | Flat Washer                                 | Use in All Models (New & Old Design) - *Old Part Not Obsolete |
| 29804*                   | None                          | Flat Washer                                 | Used only in Brake Assemblies - *Part Not Obsolete            |
| 130823                   | 129572                        | PDU Cover - 11 hole                         | All "D" Forward Carriers (new cover uses 11 capscrews)        |
| 129572                   | NLA                           | PDU Cover - 9 hole                          | Replaced by 130823 PDU Cover                                  |
| 510023                   | Refer to Note 1               | Carrier & Cap Kit                           | DSP40, DSP41  |
| 510024                   |                               | Carrier & Cap Kit                           | DSP40-P, DSP41-P  |
| 510027                   |                               | Carrier & Cap Kit                           | DDP40, DDP41  |
| 510028                   |                               | Carrier & Cap Kit                           | DSP40-P, DSP41-P  |
| 510017                   |                               | Carrier & Cap Kit                           | RDP40, RDP41  |
| 510018                   |                               | Carrier & Cap Kit                           | RSP40, RSP41  |

**Note 1:** The Carrier & Cap kits have been optimized for service. New design carriers and hardware will be provided in kits when various model options are released through production.

## Axle Shafts

Axle shafts are used in "sets", have unequal shaft lengths and may be "location specific" or "Wheel Equipment specific".

DO NOT MISPLACE AXLE SHAFTS FROM THEIR INTENDED LOCATION.

**Note:** STR - Straight, TPR - Tapered

### Axle Shafts - Single Reduction Models

| Model    | Part No. | Qty | Spline | Spline O.D. | Shaft Length | Spline Length | Flange O.D. | Flange Holes | OEM     |
|----------|----------|-----|--------|-------------|--------------|---------------|-------------|--------------|---------|
| DSH40(P) | 127437   | 1   | 41     | 1.87        | 38.976       | 4"            | 8.500       | 8(.635) STR  | 6,5,3   |
|          | 127438   | 1   | 41     | 1.87        | 43.307       | 4"            | 8.500       | 8(.635) STR  | 6,5,3   |
| DSH44(P) | 128514   | 1   | 41     | 1.87        | 38.130       | 4"            | 8.500       | 8(.773) STR  | 7,10    |
| RSH40    | 128515   | 1   | 41     | 1.87        | 42.460       | 4"            | 8.500       | 8(.773) STR  | 7,10    |
| RSH44    | 128516   | 1   | 41     | 1.87        | 38.976       | 4"            | 8.500       | 8(.948) TPR  | 2,4,7,9 |
|          | 128517   | 1   | 41     | 1.87        | 43.307       | 4"            | 8.500       | 8(.948) TPR  | 2,4,7,9 |
| 22060SH  | 128521   | 1   | 41     | 1.87        | 38.130       | 4"            | 8.500       | 8(.948) TPR  | 1       |
|          | 128522   | 1   | 41     | 1.87        | 42.460       | 4"            | 8.500       | 8(.948) TPR  | 1       |
|          | 128893   | 1   | 39     | 1.81        | 40.906       | 11"           | 5.500       | 8(.645) STR  | 10      |

- |                  |                  |
|------------------|------------------|
| 1 = Ford         | 6 = Kenworth     |
| 2 = GMC          | 7 = Volvo White  |
| 3 = Freightliner | 8 = Marmon       |
| 4 = Mack         | 9 = Western Star |
| 5 = Peterbilt    | 10 = Navistar    |

### Axle Shafts - Diff Lock Models

| Model    | Part No. | Qty | Spline | Spline O.D. | Shaft Length | Spline Length | Flange O.D. | Flange Holes | OEM     |
|----------|----------|-----|--------|-------------|--------------|---------------|-------------|--------------|---------|
| DDH40(P) | 127437   | 1   | 41     | 1.87        | 38.976       | 4"            | 8.500       | 8(.635) STR  | 3,5,6   |
|          | 128435   | 1   | 41     | 1.87        | 43.307       | 11"           | 8.500       | 8(.635) STR  | 3,5,6   |
| DDH44(P) | 128514   | 1   | 41     | 1.87        | 38.130       | 4"            | 8.500       | 8(.773) STR  | 7,10    |
|          | 128559   | 1   | 41     | 1.87        | 42.460       | 11"           | 8.500       | 8(.773) STR  | 7,10    |
| RDH40    | 128516   | 1   | 41     | 1.87        | 38.976       | 4"            | 8.500       | 8(.948) TPR  | 2,4,7,9 |
| RDH44    | 128561   | 1   | 41     | 1.87        | 43.307       | 11"           | 8.500       | 8(.948) TPR  | 2,4,7,9 |
|          | 128521   | 1   | 41     | 1.87        | 38.130       | 4"            | 8.500       | 8(.948) TPR  | 1       |
|          | 128563   | 1   | 41     | 1.87        | 42.460       | 11"           | 8.500       | 8(.948) TPR  | 1       |
|          | 129432   | 1   | 41     | 1.87        | 43.380       | 11"           | 8.500       | 8(.773) STR  | 7       |
|          | 129434   | 1   | 41     | 1.87        | 38.976       | 4"            | 8.500       | 8(.773) STR  | 7       |

- |                  |                  |
|------------------|------------------|
| 1 = Ford         | 6 = Kenworth     |
| 2 = GMC          | 7 = Volvo White  |
| 3 = Freightliner | 8 = Marmon       |
| 4 = Mack         | 9 = Western Star |
| 5 = Peterbilt    | 10 = Navistar    |



Axle Shaft Hardware

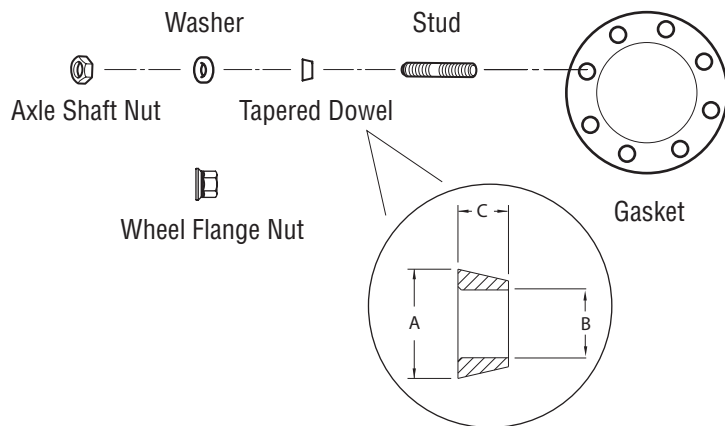

| Part Number | Description    | Dim. A | Dim. B | Dim. C | Remarks                      |
|-------------|----------------|--------|--------|--------|------------------------------|
| 013885      | Tapered Dowel  | 1.00"  | .630"  | .469"  | For 5/8" studs - Split Dowel |
| 013886      | Gasket         |        |        |        | 8 hole                       |
| 029804      | Washer         |        |        |        |                              |
| 060600      | Axle Shaft Nut |        |        |        | 5/8", 18 thread              |
| 127794      | Stud           |        |        |        | 5/8", 18 thread              |

## Gear & Pinion Kits

Dana has highly developed primary axle gearing which is only used in matched sets. These sets are identified by the mating parts listed below. Within any Dana production drive axle or genuine Spicer® Gear & Pinion service kits, these mated part numbers will appear. Because they are developed as a set with precision machining, never mix gears and pinions from different mated sets within an axle. Shortened gearing life, noise and failure may occur. Always use genuine Spicer® products

### D - Forward Axle DSH/DDH40(P), DSH/DDH44(P)

Pinion Nut Part No. 126182  
Forward Axle Service Gear Kits

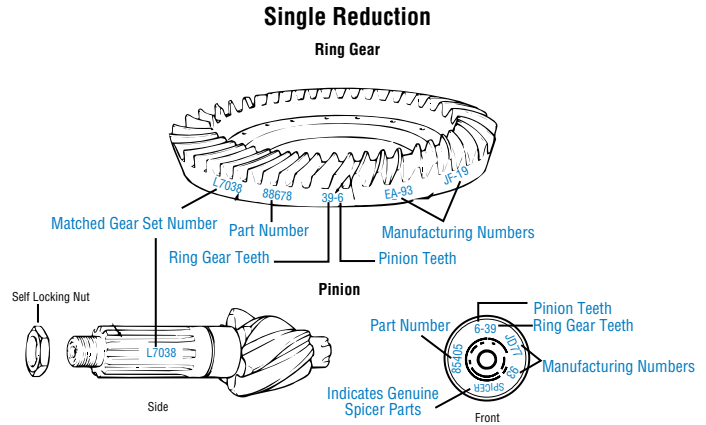

| Ratio | For Service Order Kit Part No. | Mated Gear/Pinion Set |              | Mated Gear/Pinion Set |              | Tooth Combo | Ring Gear Size (in.) |
|-------|--------------------------------|-----------------------|--------------|-----------------------|--------------|-------------|----------------------|
|       |                                | Gear (NSS)            | Pinion (NSS) | Gear (NSS)            | Pinion (NSS) |             |                      |
| 3.08  | 510104                         | 129716                | 129717       | 132230                | 132200       | 37/12       | 15.40                |
| 3.25  | 510105                         | 129721                | 129719       | 132233                | 132202       | 39/12       | 15.75                |
| 3.36  | 510106                         | 129723                | 129722       | 132235                | 132204       | 37/11       | 15.75                |
| 3.55  | 510107                         | 129721                | 129725       | 132237                | 132206       | 39/11       | 15.75                |
| 3.70  | 510108                         | 129723                | 129727       | 132239                | 132208       | 37/10       | 15.75                |
| 3.90  | 510109                         | 129721                | 129729       | 132241                | 132210       | 39/10       | 15.75                |
| 4.11  | 510110                         | 129723                | 129730       | 132243                | 132212       | 37/9        | 15.75                |
| 4.33  | 510111                         | 129721                | 129732       | 132245                | 132214       | 39/9        | 15.75                |
| 4.63  | 510112                         | 129733                | 129734       | 132246                | 132216       | 37/8        | 15.65                |
| 4.88  | 510113                         | 129736                | 129735       | 132248                | 132218       | 39/8        | 15.65                |
| 5.29  | 511894                         | 129734                | 129816       | 132250                | 132220       | 37/7        | 15.65                |
| 5.57  | 512147                         | 129736                | 129820       | 132252                | 132222       | 39/7        | 15.65                |
| 6.17  | 510462                         | 129734                | 129843       | 132254                | 132224       | 37/6        | 15.65                |
| 6.50  | 511571                         | 129736                | 127454       | 132257                | 132226       | 39/6        | 15.65                |

**R - Rear Axle**  
**RSH/RDH40, RSH/RDH44, 22060SH**  
**39-1.95" Inv Spline**

Pinion Nut Part No. 127589  
 Rear Axle Service Gear Kits

| Ratio | Service Kit Part No. | Mated Gear/Pinion Set |              | Mated Gear/Pinion Set |              | Tooth Combo | Ring Gear Size (in.) |
|-------|----------------------|-----------------------|--------------|-----------------------|--------------|-------------|----------------------|
|       |                      | Gear (NSS)            | Pinion (NSS) | Gear (NSS)            | Pinion (NSS) |             |                      |
| 3.08  | 510114               | 129738                | 129737       | 132115                | 132072       | 37/12       | 15.75                |
| 3.25  | 510115               | 129740                | 129739       | --                    | --           | 39/12       | 15.75                |
| 3.36  | 510116               | 129742                | 129741       | --                    | --           | 37/11       | 15.75                |
| 3.55  | 510117               | 129740                | 129743       | --                    | --           | 39/11       | 15.75                |
| 3.70  | 510118               | 129742                | 129744       | --                    | --           | 37/10       | 15.75                |
| 3.90  | 510119               | 129740                | 129745       | --                    | --           | 39/10       | 15.75                |
| 4.11  | 510120               | 129742                | 129746       | --                    | --           | 37/9        | 15.75                |
| 4.33  | 510121               | 129740                | 129747       | --                    | --           | 39/9        | 15.75                |
| 4.63  | 510122               | 129749                | 129748       | 132132                | 132097       | 37/8        | 15.65                |
| 4.88  | 510123               | 129751                | 129750       | 132135                | 132101       | 39/8        | 15.65                |
| 5.29  | 511518               | 129749                | 129818       | 132137                | 132104       | 37/7        | 15.65                |
| 5.57  | 511519               | 129751                | 129822       | 132139                | 132107       | 39/7        | 15.65                |
| 6.17  | 510463               | 129749                | 129844       | 132141                | 132109       | 37/6        | 15.65                |
| 6.50  | 511573               | 130206                | 127435       | 132143                | 132110       | 39/6        | 15.65                |

## Service Carriers - Single Reduction

### DSH40(P)

| Ratio | Spline | Non-Pump | Pump   |
|-------|--------|----------|--------|
| 3.08  | 41 Inv | 675740   | 675750 |
| 3.25  | 41 Inv | 675741   | 675751 |
| 3.36  | 41 Inv | 675742   | 675752 |
| 3.55  | 41 Inv | 675743   | 675753 |
| 3.70  | 41 Inv | 675744   | 675754 |
| 3.90  | 41 Inv | 675745   | 675755 |
| 4.11  | 41 Inv | 675746   | 675756 |
| 4.33  | 41 Inv | 675747   | 675757 |
| 4.63  | 41 Inv | 675748   | 675758 |
| 4.88  | 41 Inv | 675749   | 675759 |

### RSH40, 22060SH

| Ratio | Spline | Service Carrier | Notes |
|-------|--------|-----------------|-------|
| 3.08  | 41 Inv | 675780          |       |
| 3.25  | 41 Inv | 675781          |       |
| 3.36  | 41 Inv | 675782          |       |
| 3.55  | 41 Inv | 675783          |       |
| 3.70  | 41 Inv | 675784          |       |
| 3.90  | 41 Inv | 675785          |       |
| 4.11  | 41 Inv | 675786          |       |
| 4.33  | 41 Inv | 675787          |       |
| 4.63  | 41 Inv | 675788          |       |
| 4.88  | 41 Inv | 675789          |       |

### DSH44(P)

| Ratio | Spline | Non-Pump | Pump   |
|-------|--------|----------|--------|
| 5.29  | 41 Inv | 675835   | 675847 |
| 5.57  | 41 Inv | 675836   | 675848 |
| 6.17  | 41 Inv | 676155   | 676141 |
| 6.50  | 41 Inv | 676156   | 676153 |
| 7.17  | 41 Inv | NA       | 681279 |

### RSH44

| Ratio | Spline | Service Carrier | Notes |
|-------|--------|-----------------|-------|
| 5.29  | 41 Inv | 675871          |       |
| 5.57  | 41 Inv | 675872          |       |
| 6.14  | 41 Inv | 676142          |       |
| 6.50  | 41 Inv | 676154          |       |
| 7.17  | 41 Inv | 681281          |       |

**DDH40(P)**

| Ratio | Spline | Non-Pump | Pump   |
|-------|--------|----------|--------|
| 3.08  | 41 Inv | 675760   | 675770 |
| 3.25  | 41 Inv | 675761   | 675771 |
| 3.36  | 41 Inv | 675762   | 675772 |
| 3.55  | 41 Inv | 675763   | 675773 |
| 3.70  | 41 Inv | 675764   | 675774 |
| 3.90  | 41 Inv | 675765   | 675775 |
| 4.11  | 41 Inv | 675766   | 675776 |
| 4.33  | 41 Inv | 675767   | 675777 |
| 4.63  | 41 Inv | 675768   | 675778 |
| 4.88  | 41 Inv | 675769   | 675779 |

**RDH40**

| Ratio | Spline | Service Carrier | Notes |
|-------|--------|-----------------|-------|
| 3.08  | 41 Inv | 675790          |       |
| 3.25  | 41 Inv | 675791          |       |
| 3.36  | 41 Inv | 675792          |       |
| 3.55  | 41 Inv | 675793          |       |
| 3.70  | 41 Inv | 675794          |       |
| 3.90  | 41 Inv | 675795          |       |
| 4.11  | 41 Inv | 675796          |       |
| 4.33  | 41 Inv | 675797          |       |
| 4.63  | 41 Inv | 675798          |       |
| 4.88  | 41 Inv | 675799          |       |

**DDH44(P)**

| Ratio | Spline | Non-Pump | Pump   |
|-------|--------|----------|--------|
| 5.29  | 41 Inv | 675811   | 675823 |
| 5.57  | 41 Inv | 675812   | 675824 |
| 6.17  | 41 Inv | 676161   | 676159 |
| 6.50  | 41 Inv | 676162   | 676160 |

**RDH44**

| Ratio | Spline | Service Carrier | Notes |
|-------|--------|-----------------|-------|
| 5.29  | 41 Inv | 675859          |       |
| 5.57  | 41 Inv | 675860          |       |
| 6.17  | 41 Inv | 676157          |       |
| 6.50  | 41 Inv | 676158          |       |

## Yokes & Flanges

Spicer yoke part numbers shown below are PRODUCTION part numbers and are for reference only. The part numbers needed for service may vary. Please contact Driveshaft Division for price and availability of service yokes. For additional information, see Service Bulletin ABIB0607.



**Style X  
Half Round**



**Style Y  
Full Round**

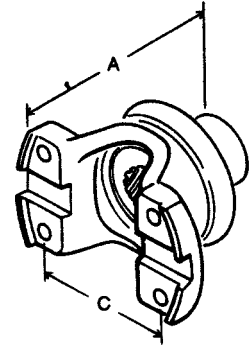

**Style Z  
Half Round  
Tapped Holes  
Bearing Strap**

### DSH/RS40, DSH/RS44, 22060SH Series

#### Forward Axle - Input / 44-2.25 Inv Spline

| Yoke & Slinger | Series | Joint Angle | Style | Dim. A | Dim. B | Dim. C | Spicer P/N    |
|----------------|--------|-------------|-------|--------|--------|--------|---------------|
| 127620         | 1610   | 35          | X     | 5.00   | 1.88   | 5.31   | 5-4-9261-1X   |
| 127550         | 1710   | 23          | Y     | 5.19   | 1.94   | 6.09   | 6-4-8451      |
| 127617         | 1710   | 30          | X     | 5.19   | 1.94   | 6.19   | 6-4-8981-1X   |
| 127622         | 1760   | 30          | X     | 5.25   | 1.94   | 7.09   | 6.3-4-5221-1X |
| 127618         | 1760   | 30          | Y     | 5.25   | 1.94   | 7.00   | 6.3-4-5221X   |
| 127621         | 1810   | 30          | X     | 5.25   | 1.94   | 7.64   | 6.5-4-4571-1X |
| 127619         | 1810   | 30          | Y     | 5.25   | 1.94   | 7.55   | 6.5-4-4571X   |

#### Forward Axle - Output / 39-1.95 Inv Spline

| Yoke & Slinger | Series | Joint Angle | Style | Dim. A | Dim. B | Dim. C | Vendor P/N  |
|----------------|--------|-------------|-------|--------|--------|--------|-------------|
| 127638         | 1610   | 45          | Y     | 6.00   | 1.88   | 5.31   | 5-4-9271X   |
| 127624         | 1710   | 45          | Y     | 6.12   | 1.94   | 6.09   | 6-4-9001X   |
| 127558         | 1710   | 30          | Y     | 5.25   | 1.94   | 6.09   | 6-4-9041X   |
| 128722         | 1710   | 39.5        | X     | 6.12   | 1.94   | 6.19   | 6-4-9001-1X |
| 128737         | 1710   | 30          | X     | 5.25   | 1.94   | 6.19   | 6-4-9041-1X |

#### Rear Axle - Pinion / 39-1.95 Inv Spline

| Yoke & Slinger | Series | Joint Angle | Style | Dim. A | Dim. B | Dim. C | Spicer P/N   |
|----------------|--------|-------------|-------|--------|--------|--------|--------------|
| 129164         | 1480   | 19          | X     | 4.34   | 1.38   | 4.19   | 3-4-13081-1X |
| 129166         | 1550   | 24.5        | X     | 4.30   | 1.38   | 4.19   | 4-4-7571-1X  |
| 128720         | 1610   | 45          | Y     | 6.00   | 1.88   | 5.31   | 5-4-9241X    |
| 128721         | 1610   | 22          | Y     | 4.72   | 1.88   | 5.31   | 5-4-9251X    |
| 127415         | 1710   | 30          | Y     | 5.25   | 1.94   | 6.09   | 6-4-9031X    |
| 127637         | 1710   | 45          | Y     | 6.12   | 1.94   | 6.09   | 6-4-8991X    |
| 128745         | 1710   | 30          | X     | 5.25   | 1.94   | 6.19   | 6-4-9031-1X  |
| 128746         | 1710   | 39.5        | X     | 6.12   | 1.94   | 6.19   | 6-4-8991-1X  |

## Oil Seal Installation Tools

This kit contains installation tools used for installing drive axle oil seals. Using these tools ensures proper installation of the seal. Failure to use these tools may result in an improperly installed or damaged seal.

### Oil Seal Driver Installation Kit 217414

#### D-Input

Use 126917



126917

#### D-Output

Use 126917 and 128706

126917

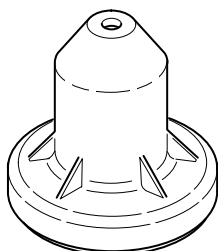

+

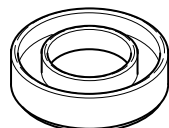

128706

#### R-Pinion

Use 126917

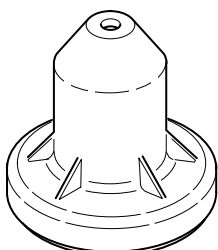

126917

| Description                          | Part Number |
|--------------------------------------|-------------|
| Air Lockout Kit - Complete           | 510052      |
| Air Lockout Repair Kit               | 510053      |
| Axle Hsg Breather Kit                | 507162      |
| Axle Hsg Hardware Kit - Thick Flange | 512087      |
| Axle Hsg Hardware Kit - Thin Flange  | 511600      |
| Basic Overhaul Kits                  |             |
| DSH40(P), DSH44(P)                   | 510393      |
| DDH40(P), DDH44(P)                   | 510399      |
| RSH40, RSH44, 22060SH                | 510398      |
| RDH40, RDH44                         | 510400      |
| Bearing Kits                         |             |
| DSH40(P), DSH44(P)                   | 512812      |
| DDH40(P), DDH44(P)                   | 512800      |
| RSH40, RSH44, 22060SH                | 512806      |
| RDH40, RDH44                         | 512805      |
| Diff Carrier & Bearing Caps Kits     |             |
| DSH40, DSH44                         | 510023      |
| DSH40(P), DSH44(P)                   | 510024      |
| DDH40, DDH44                         | 510027      |
| DDH40(P), DDH44(P)                   | 510028      |
| RSH40, RSH44, 22060SH                | 510018      |
| RDH40, RDH44                         | 510017      |

| Description                              | Part Number |
|--|-------------|
| Input Shaft Kit                          | 510593      |
| Oil Seal Driver Installation Kit         | 217414      |
| Oil Seal Shim Kits                       |             |
| Forward Axle                             | 216224      |
| Rear Axle                                | 216225      |
| Output Shaft Kit                         | 216227      |
| Ring Gear Nut & Bolt Kit                 | 508652      |
| Shift Fork & Compression Spring Kit      | 510870      |
| Wheel Diff Case Kits                     |             |
| DSH40(P), DSH44(P) - Ratios 2.64 to 3.25 | 508653      |
| DSH40(P), DSH44(P) - Ratios 3.36 to 3.90 | 508654      |
| DSH40(P), DSH44(P) - Ratios 4.11 to 4.88 | 508655      |
| DSH40(P), DSH44(P) - Ratios 5.29 to 7.17 | 508656      |
| DDH40(P), DDH44(P) - Ratios 2.64 to 3.25 | 508724      |
| DDH40(P), DDH44(P) - Ratios 3.36 to 3.90 | 508725      |
| DDH40(P), DDH44(P) - Ratios 4.11 to 4.88 | 508726      |
| DDH40(P), DDH44(P) - Ratios 5.29 to 7.17 | 508727      |
| Wheel Diff Side Gear Kit                 | 510397      |
| Wheel Diff Kit less Side Gears           | 510396      |







For spec'ing or service assistance, call 1-877-777-5360 or visit our website at [www.dana.com](http://www.dana.com)

**Dana Commercial Vehicle Products Group**

3939 Technology Drive  
Maumee, Ohio, USA 43537

[www.dana.com](http://www.dana.com)



**SPICER®**

*Drivetrain Products*



**SPICER**<sup>®</sup>  
DRIVETRAIN COMPONENTS



**Pro Gear**  
AND TRANSMISSION

## Dana DS404 - 3.36 Single Reduction Tandem Drive Axle

Pro Gear's Dana Single Reduction Tandem Drive High Performance Series Parts Manual to assist in identifying your Dana axle.

If you need any assistance identifying the correct axle unit for your truck and equipment, contact your Dana replacement part specialists at Pro Gear and Transmission.

Pro Gear and Transmission has same day shipping and 1000's of products in stock and ready to ship internationally for your next project.

For parts or service contact the Dana Axle specialists at Pro Gear & Transmission, Inc.

 CALL US

 EMAIL US

 VISIT MODEL PAGE

 VISIT ONLINE STORE

Pro Gear and Transmission, Inc | [www.progearandtransmission.com](http://www.progearandtransmission.com) | [www.pgtruckparts.com](http://www.pgtruckparts.com)  
906 West Gore St, Orlando, FL, 32805 | +1 (877)-776-4600 | +1 (407)-872191 | [parts@eprogear.com](mailto:parts@eprogear.com)