



SPICER[®]
DRIVETRAIN COMPONENTS



Pro Gear
AND TRANSMISSION

Dana DST40 - 3.9 Single Reduction Tandem Drive Axle

Pro Gear's Dana Single Reduction Tandem Drive High Performance Series Parts Manual to assist in identifying your Dana axle.

If you need any assistance identifying the correct axle unit for your truck and equipment, contact your Dana replacement part specialists at Pro Gear and Transmission.

Pro Gear and Transmission has same day shipping and 1000's of products in stock and ready to ship internationally for your next project.

For parts or service contact the Dana Axle specialists at Pro Gear & Transmission, Inc.

 CALL US

 EMAIL US

 VISIT MODEL PAGE

 VISIT ONLINE STORE

Pro Gear and Transmission, Inc | www.progearandtransmission.com | www.pgtruckparts.com
906 West Gore St, Orlando, FL, 32805 | +1 (877)-776-4600 | +1 (407)-872191 | parts@eprogear.com



Illustrated Parts List

AXIP0201

September 2006

DSH40(P), DSH44(P), DDH40(P), DDH44(P),
RSH40, RSH44, RDH40, RDH44, 22060SH

IMPORTANT: THE FORWARD MODELS (DSH40(P), DSH44(P), DDH40(P), DDH44(P) DETAILED IN THIS IPL EDITION ARE ONLY PRE JUNE 2008 DESIGNS. CONTACT DANA FOR ANY PARTS & KITS FOR MODELS PRODUCED ON OR AFTER JUNE 2008.

TABLE OF CONTENTS

Models 2

General Information 3

 How To Use Illustrated Parts List..... 3

 Model Identification 4

Identification 5

Forward Axle Parts Explode 6

Forward Axle Parts List 8

Wheel Differential Lock Assembly 11

Rear Axle Parts Explode 12

Rear Axle Parts List 13

Bearing Spacers 15

 DSH40(P), DSH44(P), DDH40(P), DDH44(P) 15

 RSH40, 22060SH, RDH44 15

Output Shaft & Axle Housing Parts Explode 16

Output Shaft & Axle Housing Parts List 17

Carrier Mounting Flange Design Change 18

 New Axle Housing Fasteners..... 18

 Casting & Service Parts Cross-Reference Listing 20

Axle Shafts 21

 Axle Shaft Hardware 22

Gear & Pinion Kits 23

Service Carriers - Single Reduction 25

 DSH40(P), DSH44(P) 25

 RSH40, 22060SH, RSH44..... 25

 DDH40(P), DDH44(P) 26

 RDH40, RDH44 26

Yokes & Flanges 27

Oil Seal Installation Tools 28

Kits and Assemblies 29

Models

The following models are represented in this publication.

Single Reduction Models

Forward Axle	Rear Axle	Axle Capacity	Gear Size
DSH40(P)	RSH40	40,000 Lbs	15.675" Hypoid Gear
DSH44(P)	RSH44	44,000 Lbs	15.675" Hypoid Gear

Single Reduction Models W/Wheel Differential Lock

Forward Axle	Rear Axle	Axle Capacity	Gear Size
DDH40(P)	RDH40	40,000 Lbs	15.675" Hypoid Gear
DDH44(P)	RDH44	44,000 Lbs	15.675" Hypoid Gear

Single Reduction - Single Axle Applications

Model	Axle Capacity	Gear Size
22060SH	40,000 Lbs	15.675" Hypoid Gear

General Information

How To Use Illustrated Parts List

Ordering Parts

- This parts book is organized in sections according to parts servicing requirements. Use the Contents or page headings and colored tabs to find information.
- Use this book to order parts for your Spicer® Axle.
- For convenience, part numbers have been included for all pieces of the carrier assembly. Some of these parts, such as the carrier and caps, are serviced only in kits or assemblies. Part numbers are for your reference only. Those parts not serviced separately are identified with NSS.

Kits and Assemblies

- Kits and Assemblies contain groups of individual or assembled parts developed for optimal replacement or repair of a service problem.
- Kits and Assemblies are shown with applicable parts groupings in the parts listing.
- See the Appendix for detailed information concerning kits applicable to this model.

Abbreviations

- **AR - As Required** - Parts that vary in quantity with each axle. Example: shims
- **NSS - Not Serviced Separately** - Items which can only be purchased in sets, kit form or service assemblies. Example: brake shoes.
- **RH/LH - Right Hand/Left Hand** - Determined as viewed from behind the vehicle looking forward.
- **“RTV” - Gasket Compound** - Formed-in-place gasket sealer. It is recommended for use on all surfaces requiring a gasket.
- **Assy - Assembly**

- **Brg - Bearing**
- **Diff - Differential**
- **Hsg - Housing**
- **Inv- Involute**
- **IASS - In Axle Speed Sensor**
- **ABS - Antilock Brake System**
- **N/A - Not Applicable**
- **Str- Straight**

Illustrations

- Illustrations show parts in assembly groups.
- Item numbers on illustrations correspond with parts listings on pages that accompany the drawings.
- Notes are included on illustrations where needed.

Parts Listings

- Parts listings are defined by parts groupings and are broken down by service assemblies.
- Parts Listings identify a part for servicing with the following categories:
 - **Item** - corresponds with numbers on illustrations for part identification
 - **Description** - specifies part name or description
 - **Quantity (Qty)** - quantity required for assembly
 - **Current Part** - service part numbers are broken down by model, type or other applicable information
 - **Notes** - define unique characteristics or replacement notes
 - **Kits / Assy's Where Used** - indicates Kits or Assemblies that contain a particular part
- **Other pertinent information is listed in tables or parts listings as required.**

Effectively Using a Parts Listing—Example

- Follow the example below to locate and order exactly what is required for servicing.

Match to items on illustration	Use to identify Part	Order this quantity for servicing	Order Part Number by Model indicated		Indicates information important to ordering or use
Item	Description	Qty	DSH40(P) DSH44(P)	DDH40(P) DDH44(P)	Notes
7	Brg Cup - Plain Half	1	129566 •	015092 •	
8	Brg Cone - Plain Half	1	129565 •	128604 •	

Summary of Kits and Assemblies

Item	Description	DSH40(P) DSH44(P)	DDH40(P) DDH44(P)	Notes
	OIL SEAL & SHIM KIT	216224	216224	Includes 49-54 & 127592
	BASIC OVERHAUL KIT	510393	510393	Contents Identified with •

Model Identification

Locating Model Designation Information

- Axle Model Identification, Part Number and Serial Number are located on a tag at the axle centerline. This information will help to locate information in this book and to identify the correct parts for servicing.

Drive Axles



- **Model Number, Part Number and Serial Number** are located on the data plate on the axle centerline

Drive Axle Assembly Tag

1. The OEM part number assigned to the axle build.
2. The specification number assigned to the axle build by Spicer. The spec number will identify all the component parts of the axle as built by Spicer, including special OEM requirements such as yokes or flanges.
3. The axle model identification.
4. The production or service part number of the carrier assembly.
5. The gear ratio of the axle.
6. The serial number of the carrier assembly assigned by the manufacturing plant.

Note: When inquiring about specific information on your axle, write down all of the above information from your tag and call your local OEM dealer or your Dana representative.

7. Country of Origin

- The axles illustrated in this book are specified with a variety of different axle shafts, according to OEM specifications. **When ordering replacement axle shafts, note the part number stamped into the flange.**



Using Model Designation to Identify Axle Components

- The Axle Model Identification number contains information that is important to understand when purchasing service parts or new components. The Model Identification number provides important vehicle, capacity and application information and model features. Use this guideline to understand your Axle Model Identification. If you need assistance, contact your Dana representative.



Forward Axle Parts Explode

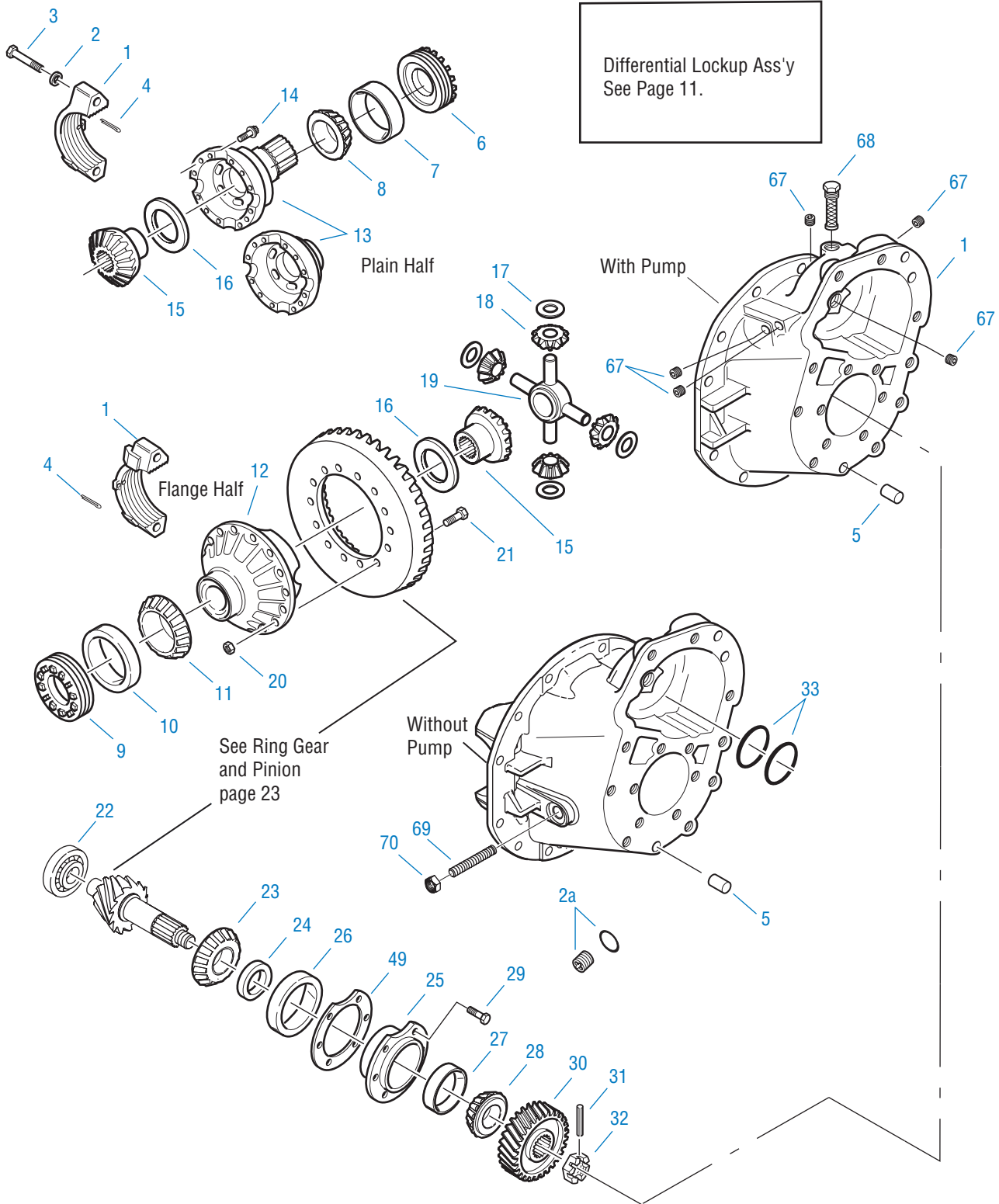

Forward Axle Parts Explode

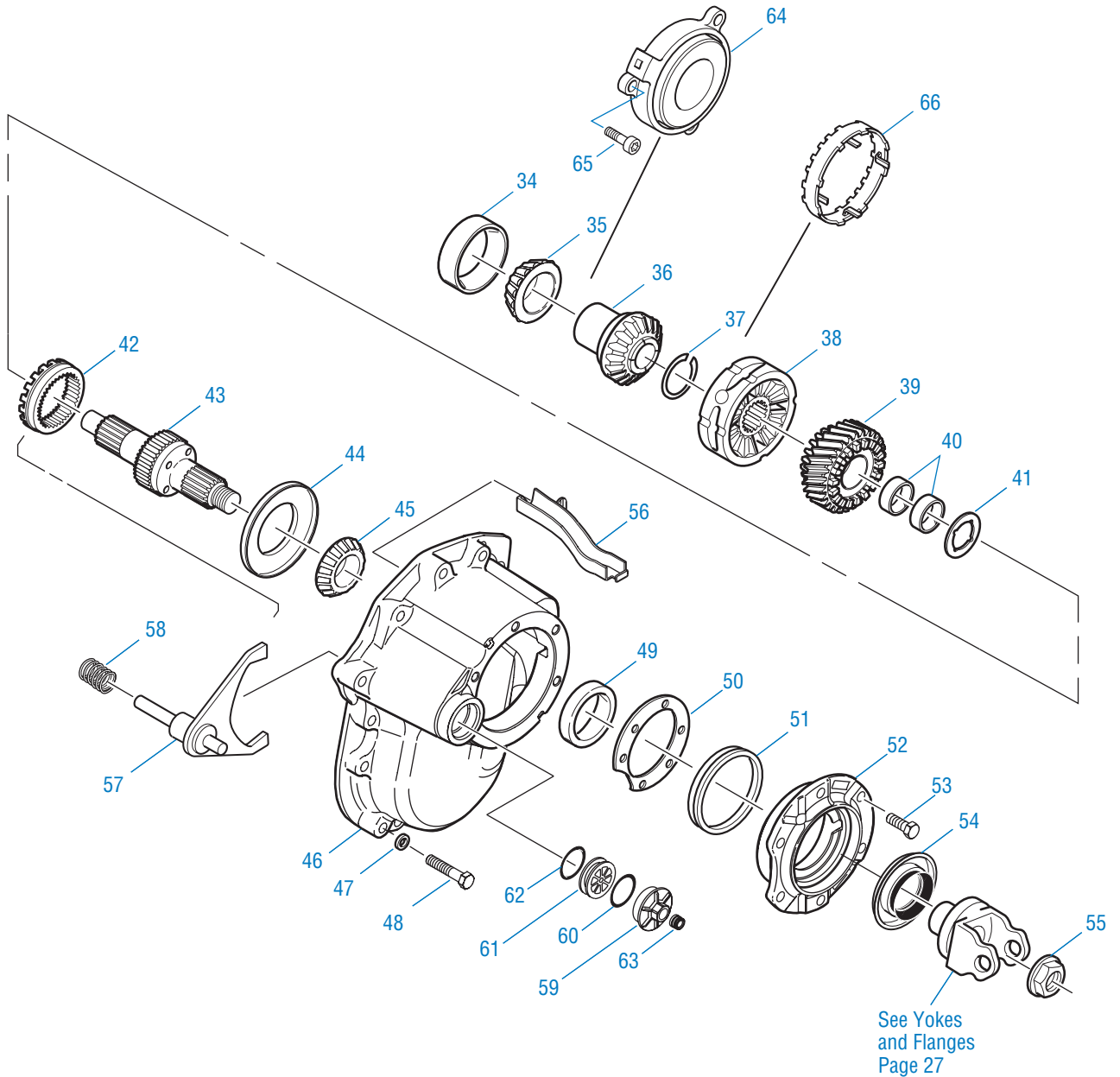

Forward Axle Parts List

Item	Part Name	Qty	DSH40(P) DSH44(P)	DDH40(P) DDH44(P)	Remarks
	BASIC OVERHAUL KIT		510393	510399	Contents Identified with •
	BEARING KIT		512812	512800	
1	DIFF CARRIER & BEARING CAPS KIT				Includes Items 1-3, 5, 67, 69-71 and Items 8-11 on p.17, See Note 1
	DSH40		510023	-	Casting #130809
	DSH40P		510024	-	Casting #130819
	DDH40		-	510027	Casting #130814
	DDH40P		-	510028	Casting #130814
2	Flat Washer	4	210288	210288	
2a	Plug & O-ring Assembly	1	131809	131809	O-ring not serviced seperately
3	Capscrew	4	210095	210095	
4	Cotter Pin	2	090873	090873	
5	Dowel Pin	2	007641	007641	
6	Diff Brg Adjuster - Plain Half	1	129130	128616	
7	Brg Cup - Plain Half	1	129566 •	015092 •	
8	Brg Cone - Plain Half	1	129565 •	128604 •	
9	Diff Brg Adjuster - Flange Half	1	129128	129128	
10	Brg Cup - Flange Half	1	129564 •	129564 •	
11	Brg Cone - Flange Half	1	129563 •	129563 •	
	WHEEL DIFF CASE KITS				Includes items 12-14
12	Diff Case-RH (Flg Half) - NSS129464	1	508653	508724	Ratios 3.08 to 3.55
	NSS129465		508654	508725	Ratios 3.70 to 4.11
	NSS129466		508655	508726	Ratios 4.33 to 4.88
	NSS129467		508656	508727	Ratios 5.29 to 7.17
13	Diff Case-LH (Plain Half)-NSS	1	127498	128607	Order kits listed above
14	Capscrew	12	127465	128619	

Note 1: On June 3, 2002, the design of carrier mounting flange of the DSH40(P), DSH44(P), DDH40(P), DDH44(P) and RSH40, RSH44, 22060SH, RDH40 and RDH44 models changed. The new carrier's are designed with a "Thick Flange". Carriers designed with a "Thick Flange" require the use of "long" capscrews. The fastening hardware for these models can be found on pages 16-18 of this IPL. Refer to Spicer bulletin ABIB-0210R1 for further details.

Forward Axle Parts List

Item	Part Name	Qty	DSH40(P) DSH44(P)	DDH40(P) DDH44(P)	Remarks
	WHEEL DIFF SIDE GEAR KIT		510397	510397	Includes items 15-19
	WHEEL DIFF KIT w/o SIDE GEARS		510396	510396	Includes items 16-19
15	Side Gear 41 Inv spline	2	127368	127368	
16	Side Gear Thrust Washer	2	127386 •	127386 •	
17	Side Pinion Thrust Washer	4	129305 •	129305 •	
18	Side Pinion	4	129765	129765	
19	Diff Spider	1	129599	129599	
	RING GEAR NUT & BOLT KIT		508652	508652	Includes items 20-21
20	Nut	16	126216	126216	
21	Bolt	16	129686	129686	
22	Pinion Pilot Brg	1	127484 •	127484 •	
23	Pinion Brg Cone - Inner	1	129560 •	129560 •	
24	Pinion Brg Spacer	AR			Pinion Bearing Spacer pg. 15
25	Pinion Brg Cage & Cup Assy Cage #127488C NSS	1	129767	129767	Includes item 25-27
26	Pinion Brg Cup - Inner	1	129561 •	129561 •	
27	Pinion Brg Cup - Outer	1	012495 •	012495 •	
28	Pinion Brg Cone - Outer	1	127535 •	127535 •	
29	Capscrew	6	210115	210115	
30	Pinion Helical Gear	1	127523	127523	
31	Roll Pin	1	118807	118807	
32	Slotted Pinion Nut	1	126182	126182	
33	Output Shaft O-Ring	2	127545 •	127545 •	
34	Output Shaft Brg Cup	1	127536 •	127536 •	
35	Output Shaft Brg Cone	1	110812 •	110812 •	
36	Output Shaft Side Gear	1	127645	127645	
37	Snap Ring	1	085997 •	085997 •	
38	Inter-Axle Diff Assy	1	129771	129771	Replaces 128634
39	Helical Side Gear & Bushing Assy Gear #130906 NSS (Incls item 40)	1	130907	130907	Replaces 127495
40	Helical Gear Bushing	2	129371	129371	Replaces 127543
41	Helical Gear Thrust Washer	1	128702 •	128702 •	
42	Lockout Sliding Clutch	1	127510	127510	
43	INPUT SHAFT KIT Input Shaft 129770 NSS	1	510593	510593	Includes Items 41, 43, 55 Replaces 510394
44	Oil Retainer	1	128700 •	128700 •	

Forward Axle Parts List

Item	Part Name	Qty	DSH40(P) DSH44(P)	DDH40(P) DDH44(P)	Remarks
45	Input Shaft Bearing Cone	1	129558 •	129558 •	Replaces 820643
46	PDU Cover	1	130823	130823	See Note 2 Replaced 129572
46A	Magnet	1	129494	129494	Not Illustrated, located inside PDU Cover
47	Washer	11	128415	128415	
48	Capscrew Long	11	210091	210091	See Note 2
49	Bearing Cup	1	129559	129559	Optional Part No. 1008912
	OIL SEAL & SHIM KIT	1	216224	216224	Includes items 50, 54 & 127592 (item 17 on p. 17)
50	Shim.003	AR	127595 •	127595 •	
	Shim.005		127596 •	127596 •	
	Shim.010		127597 •	127597 •	
	Shim.020		127598 •	127598 •	
	Shim.030		127599 •	127599 •	
51	Oil Seal-V-Ring	1	128703 •	128703 •	
52	Input Brg Cover Assy - #129574C	1	129766	129766	Includes item 49
53	Bearing Cover Cap Screw	6	210115	210115	
54	Oil Seal	1	127591 •	127591 •	
55	Locknut	1	128049	128049	In 510394 Kit (M42x1.5)
56	Lube Trough	1	129577	129577	
	AIR LOCKOUT KIT - COMPLETE	1	510052	510052	Includes items 57- 59, 61- 62
	AIR LOCKOUT REPAIR KIT	1	510053	510053	Includes items 59, 61- 62
57	Shift Fork Assy - NSS	1	129856	129856	Order Kit 510870
58	Compression Spring	1	129859	129859	
	SHIFT FORK & COMPRESSION SPRING KIT	1	510870	510870	Includes items 57 & 58
59	Piston Cover Assy	1	129573	129573	Includes Cover #129578 & Item 60
60	O-Ring	1	129579	129579	
61	Piston	1	129580	129580	
62	O-Ring	1	210180	210180	
63	Shipping Plug	1	599792	599792	
64	Lube Pump Assembly	1	127534	127534	Pump Models Only
65	Capscrew	3	127551	127551	Pump Models Only
66	Drive Coupling - Service	1	128628	128628	Pump Models Only
67	Pipe Plug	5	090897	090897	Pump Models Only
68	Filter Screen Assy	1	127649	127649	Pump Models Only
69	Thrust Screw	1	126193	126193	
70	Jam Nut	1	210184	210184	
71	RTV - Sealant	1	107276S •	107276S •	Not Illustrated

Note 2: On June 3, 2002, the design of the power divider cover changed. The original PDU covers (P/N: 129572) have 9 holes and require 9 fasteners. The current design PDU covers (P/N: 130823) have 11 holes and require the use of 11 long fasteners. The new 130823 PDU covers now replace the 129572 covers in service.

- The 9-hole PDU cover will NOT work on a carrier machined with 11 holes.
- A new 11-hole PDU cover will adapt to a 9-hole carrier without modifications. Refer to Spicer bulletin ABIB-0210 for further details.

Wheel Differential Lock Assembly

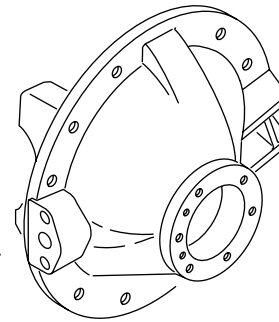

Rear carrier illustrated above. Parts for forward carrier are identical to the rear carrier.

Item	Part Name	Qty	DDH40(P) DDH44(P) RDH40 RDH44	Remarks
1	Fixed Curvic Clutch Gear	1	128627	
2	Snap Ring	1	129433	
3	SL Curvic Clutch Gear - 41 Inv spline	1	126840	
4	Compression Spring	1	128614	
	SHIFT FORK ASSY		217465	Includes items 5-6
5	Shift Fork - NSS	1	128609	
6	Spring Pin	1	210020	
7	Push Rod	1	128617	
8	Piston Driver	1	128640	
9	Set Screw	1	128618	
10	Piston	1	128624	
11	O-Ring	1	210180	
12	Piston Cover	1	129425	
13	Gasket	1	128643	
14	Capscrew - Flg Head	2	128744	
15	Capscrew	1	129946	
16	Washer	1	129034	
17	Switch	1	129035	
18	Wiring Harness	1	129047	Not Illustrated
19	Washer	1	210288	Not Illustrated, Note 1

Rear Axle Parts Explode



Rear Axle Parts List

Item	Part Name	Qty	RSH40 RSH44 22060SH	RDH40 RDH44	Remarks
	BASIC OVERHAUL KIT		510398	510400	Contents Identified with •
	BEARING KIT		512806	512805	
1	DIFF CARR & BRG CAPS KIT				
	Includes items 1-3, 33-34 and items 8-11 on p. 17		510018	-	Casting # 130824 See Note 1
			-	510017	Casting # 130827
2	Flat Washer	4	210288	210288	
2a	Plug & O-ring Assembly	1	131809	131809	O-ring not serviced seperately
3	Capscrew	4	210095	210095	
4	Cotter Pin	2	090873	090873	
5	Diff Brg Adjuster - Plain Half	1	129130	128616	
6	Bearing Cup - Plain Half	1	129566 •	015092 •	
7	Bearing Cone - Plain Half	1	129565 •	128604 •	
8	Diff Brg Adjuster - Flange Half	1	129128	129128	
9	Bearing Cup - Flange Half	1	129564 •	129564 •	
10	Bearing Cone - Flange Half	1	129563 •	129563 •	
	WHEEL DIFF. CASE KITS				Includes items 11-13
11	Diff Case-LH (Flg Half) - NSS129464	1	508653	508724	Ratios 3.08 to 3.55
	NSS129465		508654	508725	Ratios 3.70 to 4.11
	NSS129466		508655	508726	Ratios 4.33 to 4.88
	NSS129467		508656	508727	Ratios 5.29 to 7.17
12	Diff Case-RH(Plain Half)-NSS	1	127498	128607	Order kits listed above
13	Capscrew	12	127465	128619	
	WHEEL DIFF SIDE GEAR KIT		510397	510397	Includes items 14-18
	WHEEL DIFF KIT w/o SIDE GEARS		510396	510396	Includes items 15-18
14	Side Gear 41 Inv spline	2	127368	127368	
15	Side Gear Thrust Washer	2	127386 •	127386 •	
16	Side Pinion Thrust Washer	4	129305 •	129305 •	
17	Side Pinion	4	129765	129765	
18	Diff Spider	1	129599	129599	

Note 1: On June 3, 2002, the design of carrier mounting flange of the DSH40(P), DSH44(P), DDH40(P), DDH44(P) and RSH40, RSH44, 22060SH, RDH40 and RDH44 models changed. The new carrier's are designed with a "Thick Flange". Carriers designed with a "Thick Flange" require the use of "long" capscrews. The fastening hardware for these models can be found on pages 16-18 of this IPL. Refer to Spicer bulletin ABIB-0210R1 for further details.

Rear Axle Parts List

Item	Part Name	Qty	RSH40 RSH44 22060SH	RDH40 RDH44	Remarks
	RING GEAR NUT & BOLT KIT		508652	508652	Includes items 19-20
19	Nut	16	126216	126216	
20	Bolt	16	129686	129686	
21	Pinion Pilot Brg	1	127485 •	127485 •	
22	Pinion Brg Cone - Inner	1	129562 •	129562 •	
23	Pinion Brg Spacer	AR			Pinion Bearing Spacer pg. 15
24	Pinion Brg Cage & Cup Assy Cage #127481C NSS	1	129768	129768	Includes items 24-26
25	Pinion Brg Cup - Inner	1	129561 •	129561 •	
26	Pinion Brg Cup - Outer	1	012495 •	012495 •	
27	Pinion Brg Cone - Outer	1	012496 •	012496 •	
28	Capscrew	6	210115	210115	
	OIL SEAL & SHIM KIT		216225	216225	Includes items 29-30, 34
29	Shim.003	AR	127595 •	127595 •	
	Shim.005		127596 •	127596 •	
	Shim.010		127597 •	127597 •	
	Shim.020		127598 •	127598 •	
	Shim.030		127599 •	127599 •	
30	Oil Seal	1	127591 •	127591 •	
31	Pinion Nut	1	127589	127589	M36 x 1.5
32	Thrust Screw	1	126193	126193	
33	Jam Nut	1	210184	210184	
34	RTV - Sealant	1	107276S •	107276S •	Not Illustrated

NSS - Not Sold Separately

Bearing Spacers

DSH40(P), DDH40 (P)

Part Number	Spacer Thickness
129079	.797
129080	.798
129081	.800
129082	.801
129083	.802
129084	.803
129085	.804
129086	.806
129087	.807
129088	.808
129089	.809*
129090	.810*
129091	.811*
129093	.812*
129097	.814*
129099	.815*
129101	.816*
129103	.817*
129105	.818*
129107	.819*
129109	.820*
129111	.821
129113	.822
129115	.823
129117	.824
129119	.825
129120	.826
129121	.828
129122	.829
129123	.830
129124	.831
129125	.832
129126	.833

* Most Popular

RSH40, RDH40

Part Number	Spacer Thickness
91552	.623
91553	.624
91554	.625
91555	.626
91556	.627
91557	.628
91558	.629
91559	.630
91560	.631
91561	.632
91562	.633
91564	.634*
91566	.635*
91568	.636*
91572	.637*
91576	.638*
91580	.639*
91584	.640*
91588	.641*
91592	.642*
91596	.643*
91600	.644*
91602	.645
91604	.646
91606	.647
91608	.648
91610	.649
91611	.650
91612	.651
91613	.652
91614	.653
91615	.654

* Most Popular

Output Shaft & Axle Housing Parts Explode

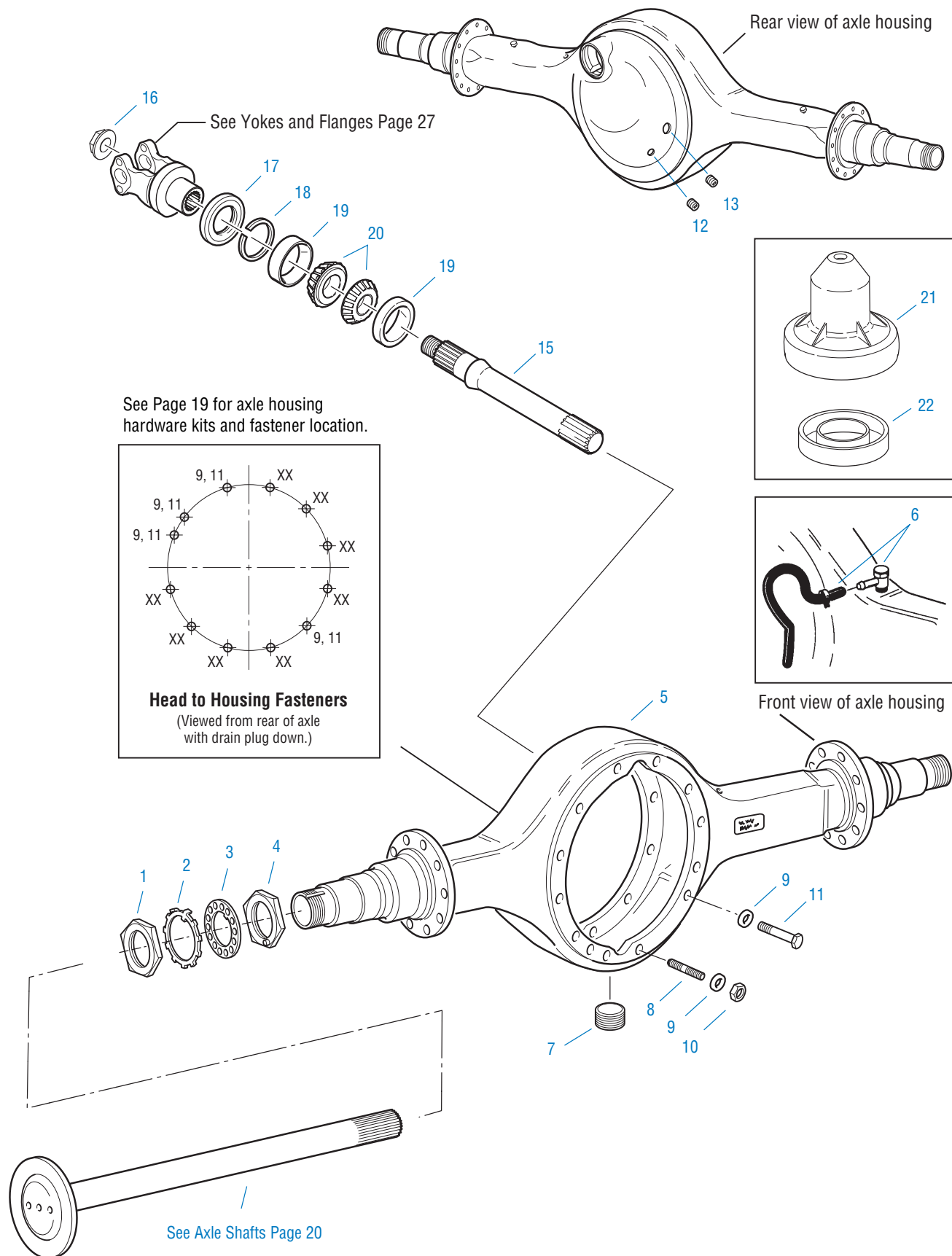

Output Shaft & Axle Housing Parts List

Item	Part Name	Qty	Part Number	Remarks
1	Outer Bearing Adjuster Nut	2	119881	
2	Lockwasher - w/Tab	2	129132	
3	Dowel-Type Lockwasher	2	119883	
4	Inner Bearing Adjuster Nut	2	119882	
5	Axle Housing Assy	1		See your OEM Catalog
6	U-Tube Breather Kit	1	507162	
7	Magnetic Drain Plug - 3/4"	1	054254	All D/R models
8 -11	Carrier to Hsg Fasteners			See Page 19
12	Non-Magnetic Plug 3/4"	1	129492	
12	Magnetic Plug - 3/4"	1	129491	
13	Temperature Sensor Plug 1/2"	1	90898	
14	Lube Tag (for 3/4" Plug)	1	129486	Part - Not Illustrated
	OUTPUT SHAFT KIT	1	216227	Includes Items 15-16 Replaces 510395
15	Output Shaft - #127646 NSS			
16	Locknut - Hex	1	127588	M39 x 1.5
17	Oil Seal	1	127592 •	
18	Snap Ring .103"	1	129594 •	
19	Bearing Cup	2	127539 •	
20	Bearing Cone	2	127540 •	
21	Seal Driver	1	126917	In Kit 217414 - See Page 28
22	Adapter	1	128706	In Kit 217414 - See Page 28
23	Loctite Adhesive	1	129293	Not Illustrated, .5 ml Tube
24	RTV - Sealant	1	107276S •	Not Illustrated, 3 oz. Tube

• Included in Bearing & Basic Overhaul Kits

NSS - Not Sold Separately

Carrier Mounting Flange Design Change

Beginning June 3rd, 2002, the nominal thickness of the carrier to housing flange was increased in the DSH40(P), DSH44(P), DDH40(P), DDH44(P) and RSH40, RSH44, 22060SH, RDH40 and RDH44 models. This change required the use of new fastener parts. A new (45mm) capscrew (P/N 130836) was released as it replaced both 210173 and 130158 old design capscrews. Additionally, a much thicker boss was added to the flange at the 12:00 & 6:00 o'clock positions. These new thicker flange bosses require an even longer (70mm) capscrew (P/N 130837). A thicker and larger diameter flat washer (P/N 130877) was also released as part of this upgrade. The new washer replaces existing washer 29804. The existing stud (P/N 127641) and nut (P/N 127567) are not affected by these changes and will continue to be used.

SERVICE CARRIER NOTE:

Stock levels of both early design service carriers and new "Thick Flange" design service carriers exist. If you have a vehicle that was originally equipped with a Spicer axle built with the "Thick Flange" carrier design, it can be universally serviced with an early style (Thin Flange) Service Carrier. The repairing dealer must simply make sure to use the correct axle housing hardware parts when installation is done. New service carriers built with the thick flange design, will include the necessary thick flange hardware kit to minimize any down time to the customer.

- Differentials with "THICK FLANGE" carriers use axle housing hardware kit (P/N 512087).
- Early design differentials with "THIN FLANGE" carriers use axle housing hardware kit (P/N 511600).
- GM Vehicles requires the use of double-ended capscrews at the housing fastener location. Double-ended capscrews for thick flange design carriers are not available at this time. GM vehicles must be serviced with early design carriers, available only through GM.

New Axle Housing Fasteners

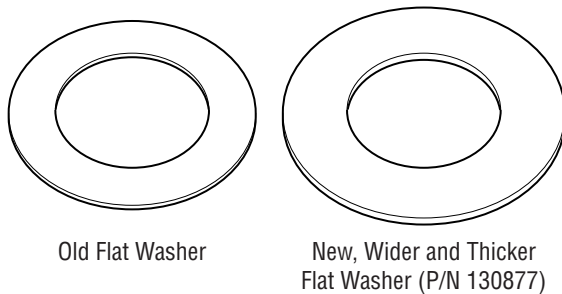

IMPORTANT!

Spicer does not recommend the mixing of various designs carrier-to-housing capscrews on the same assembly. Whether mixing or not, torques must be measured using a calibrated torque wrench.

Failure to re-torque bolts and nuts to proper specifications may lead to carrier to housing leaks and possible component damage.

Axle Housing Fasteners

On June 3, 2002 the DSP40(P), DSP 41(P), DDP40(P), DDP41(P), RSP40, RSP41, RDP40 and RDP41 models were upgraded to the new "Thick Flange" carrier design as fully detailed in Spicer bulletin AXIP-0210R1. Shown below are the axle housing hardware kits and fastener locations for both variations. View fastener locations as if installing differential into the axle housing.

Thick Flange – After 6/3/02



Original Design Flange – Before 6/3/02*

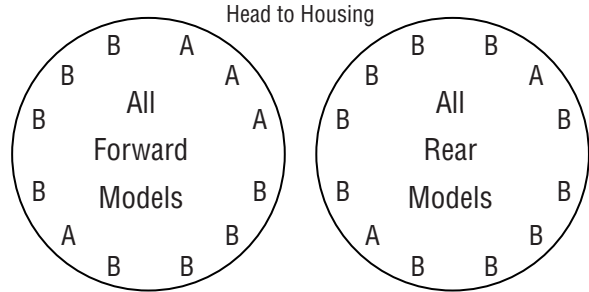

Note: GM models require a special double-ended capscrews. They continue to use carriers with the original design thin flange. At this time Spicer does not have a double-ended capscrew for "Thick Flange" models.

A – 127641 Studs & 127567 Nuts
 B – 130836 Capscrews – Short (45 mm)
 C – 130837 Capscrews – Long (70 mm)
 D – 130877 Flat Washers – All Locations

512087 Hardware Kit (Thick Flange)

Part No.	Qty.	Description
107276S	1	RTV Sealant 3 oz. Tube
127567	4	Nut
127641	4	Stud
129293	1	Loctite 271 0.5 ml. Tube
130836	8	Capscrew (45 mm) - Short
130837	4	Capscrew (70 mm) - Long
130877	12	Washer
SHAIS136	1	Instruction Sheet - Thick Flange

511600 Hardware Kit

Part No.	Qty.	Description
107276S	1	RTV Sealant 3 oz. Tube
127567	4	Nut
127641	4	Stud
129293	1	Loctite 271 0.5 ml. Tube
130836	10	Capscrew (was 130158)
130877	12	Washer (was 29804)
SHAIS131	1	Instruction Sheet

Casting & Service Parts Cross-Reference Listing

Below are two helpful cross-reference charts. Chart-A shows "casting" numbers that can quickly identify the old design parts versus the new design parts. Chart-B is a "service parts" cross-reference listing. The part numbers in this chart are sorted by part type; refer to the "New Part Description" column.

Chart A: Part Number Cross-Reference - Casting Numbers

New Casting Part No.	Old Casting Part No.	Description	Model
130809	129539, 129540	Diff. Carrier Casting	DSP40, DSP 41
130814*	129550	Diff. Carrier Casting	DDP40, DDP40-P, DDP41, DDP41-P
130819*	129551	Diff. Carrier Casting	DSP40-P, DSP 41-P
130822	129571	PDU Cover Casting	All "D" Forward Carriers - 11 hole
130824	129351C, 129541	Diff. Carrier Casting	RSP40, RSP41
130827*	128600	Diff. Carrier Casting	RDP40, RDP41

* New Thick Flange Carriers not in production yet, production to start 1st quarter 2003.

Chart B: Part Number Cross-Reference - Service Parts

Current Service Part No.	Replaces Old Service Part No.	New Part Description	Notes
511600	None	Axle Hsg hardware Kit - Thin Flange Models	Use only in Models with Thin Flange Carrier Design
512087	None	Axle Hsg hardware Kit - Thick Flange Models	Use only in Models with Thick Flange Carrier Design
130836	130158, 210173	Capscrew - 45 mm	Use in All Models (New & Old Design)
130837	None	Capscrew - 70 mm	Use only in Models with Thick Flange Carrier Design
130158	NLA	Capscrew - 40 mm	Replaced by 130836 Capscrew
210173	NLA	Capscrew - 40 mm	Replaced by 130836 Capscrew
130877	29804*	Flat Washer	Use in All Models (New & Old Design) - *Old Part Not Obsolete
29804*	None	Flat Washer	Used only in Brake Assemblies - *Part Not Obsolete
130823	129572	PDU Cover - 11 hole	All "D" Forward Carriers (new cover uses 11 capscrews)
129572	NLA	PDU Cover - 9 hole	Replaced by 130823 PDU Cover
510023	Refer to Note 1	Carrier & Cap Kit	DSP40, DSP41
510024		Carrier & Cap Kit	DSP40-P, DSP41-P
510027		Carrier & Cap Kit	DDP40, DDP41
510028		Carrier & Cap Kit	DSP40-P, DSP41-P
510017		Carrier & Cap Kit	RDP40, RDP41
510018		Carrier & Cap Kit	RSP40, RSP41

Note 1: The Carrier & Cap kits have been optimized for service. New design carriers and hardware will be provided in kits when various model options are released through production.

Axle Shafts

Axle shafts are used in "sets", have unequal shaft lengths and may be "location specific" or "Wheel Equipment specific".

DO NOT MISPLACE AXLE SHAFTS FROM THEIR INTENDED LOCATION.

Note: STR - Straight, TPR - Tapered

Axle Shafts - Single Reduction Models

Model	Part No.	Qty	Spline	Spline O.D.	Shaft Length	Spline Length	Flange O.D.	Flange Holes	OEM
DSH40(P)	127437	1	41	1.87	38.976	4"	8.500	8(.635) STR	6,5,3
	127438	1	41	1.87	43.307	4"	8.500	8(.635) STR	6,5,3
DSH44(P)	128514	1	41	1.87	38.130	4"	8.500	8(.773) STR	7,10
RSH40	128515	1	41	1.87	42.460	4"	8.500	8(.773) STR	7,10
RSH44	128516	1	41	1.87	38.976	4"	8.500	8(.948) TPR	2,4,7,9
	128517	1	41	1.87	43.307	4"	8.500	8(.948) TPR	2,4,7,9
22060SH	128521	1	41	1.87	38.130	4"	8.500	8(.948) TPR	1
	128522	1	41	1.87	42.460	4"	8.500	8(.948) TPR	1
	128893	1	39	1.81	40.906	11"	5.500	8(.645) STR	10

- | | |
|------------------|------------------|
| 1 = Ford | 6 = Kenworth |
| 2 = GMC | 7 = Volvo White |
| 3 = Freightliner | 8 = Marmon |
| 4 = Mack | 9 = Western Star |
| 5 = Peterbilt | 10 = Navistar |

Axle Shafts - Diff Lock Models

Model	Part No.	Qty	Spline	Spline O.D.	Shaft Length	Spline Length	Flange O.D.	Flange Holes	OEM
DDH40(P)	127437	1	41	1.87	38.976	4"	8.500	8(.635) STR	3,5,6
	128435	1	41	1.87	43.307	11"	8.500	8(.635) STR	3,5,6
DDH44(P)	128514	1	41	1.87	38.130	4"	8.500	8(.773) STR	7,10
	128559	1	41	1.87	42.460	11"	8.500	8(.773) STR	7,10
RDH40	128516	1	41	1.87	38.976	4"	8.500	8(.948) TPR	2,4,7,9
RDH44	128561	1	41	1.87	43.307	11"	8.500	8(.948) TPR	2,4,7,9
	128521	1	41	1.87	38.130	4"	8.500	8(.948) TPR	1
	128563	1	41	1.87	42.460	11"	8.500	8(.948) TPR	1
	129432	1	41	1.87	43.380	11"	8.500	8(.773) STR	7
	129434	1	41	1.87	38.976	4"	8.500	8(.773) STR	7

- | | |
|------------------|------------------|
| 1 = Ford | 6 = Kenworth |
| 2 = GMC | 7 = Volvo White |
| 3 = Freightliner | 8 = Marmon |
| 4 = Mack | 9 = Western Star |
| 5 = Peterbilt | 10 = Navistar |

Axle Shaft Hardware

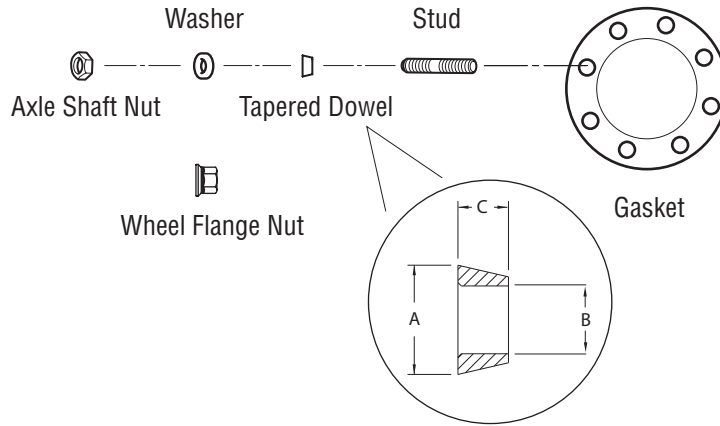

Part Number	Description	Dim. A	Dim. B	Dim. C	Remarks
013885	Tapered Dowel	1.00"	.630"	.469"	For 5/8" studs - Split Dowel
013886	Gasket				8 hole
029804	Washer				
060600	Axle Shaft Nut				5/8", 18 thread
127794	Stud				5/8", 18 thread

Gear & Pinion Kits

Dana has highly developed primary axle gearing which is only used in matched sets. These sets are identified by the mating parts listed below. Within any Dana production drive axle or genuine Spicer® Gear & Pinion service kits, these mated part numbers will appear. Because they are developed as a set with precision machining, never mix gears and pinions from different mated sets within an axle. Shortened gearing life, noise and failure may occur. Always use genuine Spicer® products



D - Forward Axle DSH/DDH40(P), DSH/DDH44(P)

Pinion Nut Part No. 126182
Forward Axle Service Gear Kits

Ratio	For Service Order Kit Part No.	Mated Gear/Pinion Set		Mated Gear/Pinion Set		Tooth Combo	Ring Gear Size (in.)
		Gear (NSS)	Pinion (NSS)	Gear (NSS)	Pinion (NSS)		
3.08	510104	129716	129717	132230	132200	37/12	15.40
3.25	510105	129721	129719	132233	132202	39/12	15.75
3.36	510106	129723	129722	132235	132204	37/11	15.75
3.55	510107	129721	129725	132237	132206	39/11	15.75
3.70	510108	129723	129727	132239	132208	37/10	15.75
3.90	510109	129721	129729	132241	132210	39/10	15.75
4.11	510110	129723	129730	132243	132212	37/9	15.75
4.33	510111	129721	129732	132245	132214	39/9	15.75
4.63	510112	129733	129734	132246	132216	37/8	15.65
4.88	510113	129736	129735	132248	132218	39/8	15.65
5.29	511894	129734	129816	132250	132220	37/7	15.65
5.57	512147	129736	129820	132252	132222	39/7	15.65
6.17	510462	129734	129843	132254	132224	37/6	15.65
6.50	511571	129736	127454	132257	132226	39/6	15.65

R - Rear Axle
RSH/RDH40, RSH/RDH44, 22060SH
39-1.95" Inv Spline

Pinion Nut Part No. 127589
 Rear Axle Service Gear Kits

Ratio	Service Kit Part No.	Mated Gear/Pinion Set		Mated Gear/Pinion Set		Tooth Combo	Ring Gear Size (in.)
		Gear (NSS)	Pinion (NSS)	Gear (NSS)	Pinion (NSS)		
3.08	510114	129738	129737	132115	132072	37/12	15.75
3.25	510115	129740	129739	--	--	39/12	15.75
3.36	510116	129742	129741	--	--	37/11	15.75
3.55	510117	129740	129743	--	--	39/11	15.75
3.70	510118	129742	129744	--	--	37/10	15.75
3.90	510119	129740	129745	--	--	39/10	15.75
4.11	510120	129742	129746	--	--	37/9	15.75
4.33	510121	129740	129747	--	--	39/9	15.75
4.63	510122	129749	129748	132132	132097	37/8	15.65
4.88	510123	129751	129750	132135	132101	39/8	15.65
5.29	511518	129749	129818	132137	132104	37/7	15.65
5.57	511519	129751	129822	132139	132107	39/7	15.65
6.17	510463	129749	129844	132141	132109	37/6	15.65
6.50	511573	130206	127435	132143	132110	39/6	15.65

Service Carriers - Single Reduction

DSH40(P)

Ratio	Spline	Non-Pump	Pump
3.08	41 Inv	675740	675750
3.25	41 Inv	675741	675751
3.36	41 Inv	675742	675752
3.55	41 Inv	675743	675753
3.70	41 Inv	675744	675754
3.90	41 Inv	675745	675755
4.11	41 Inv	675746	675756
4.33	41 Inv	675747	675757
4.63	41 Inv	675748	675758
4.88	41 Inv	675749	675759

RSH40, 22060SH

Ratio	Spline	Service Carrier	Notes
3.08	41 Inv	675780	
3.25	41 Inv	675781	
3.36	41 Inv	675782	
3.55	41 Inv	675783	
3.70	41 Inv	675784	
3.90	41 Inv	675785	
4.11	41 Inv	675786	
4.33	41 Inv	675787	
4.63	41 Inv	675788	
4.88	41 Inv	675789	

DSH44(P)

Ratio	Spline	Non-Pump	Pump
5.29	41 Inv	675835	675847
5.57	41 Inv	675836	675848
6.17	41 Inv	676155	676141
6.50	41 Inv	676156	676153
7.17	41 Inv	NA	681279

RSH44

Ratio	Spline	Service Carrier	Notes
5.29	41 Inv	675871	
5.57	41 Inv	675872	
6.14	41 Inv	676142	
6.50	41 Inv	676154	
7.17	41 Inv	681281	

DDH40(P)

Ratio	Spline	Non-Pump	Pump
3.08	41 Inv	675760	675770
3.25	41 Inv	675761	675771
3.36	41 Inv	675762	675772
3.55	41 Inv	675763	675773
3.70	41 Inv	675764	675774
3.90	41 Inv	675765	675775
4.11	41 Inv	675766	675776
4.33	41 Inv	675767	675777
4.63	41 Inv	675768	675778
4.88	41 Inv	675769	675779

RDH40

Ratio	Spline	Service Carrier	Notes
3.08	41 Inv	675790	
3.25	41 Inv	675791	
3.36	41 Inv	675792	
3.55	41 Inv	675793	
3.70	41 Inv	675794	
3.90	41 Inv	675795	
4.11	41 Inv	675796	
4.33	41 Inv	675797	
4.63	41 Inv	675798	
4.88	41 Inv	675799	

DDH44(P)

Ratio	Spline	Non-Pump	Pump
5.29	41 Inv	675811	675823
5.57	41 Inv	675812	675824
6.17	41 Inv	676161	676159
6.50	41 Inv	676162	676160

RDH44

Ratio	Spline	Service Carrier	Notes
5.29	41 Inv	675859	
5.57	41 Inv	675860	
6.17	41 Inv	676157	
6.50	41 Inv	676158	

Yokes & Flanges

Spicer yoke part numbers shown below are PRODUCTION part numbers and are for reference only. The part numbers needed for service may vary. Please contact Driveshaft Division for price and availability of service yokes. For additional information, see Service Bulletin ABIB0607.



**Style X
Half Round**



**Style Y
Full Round**



**Style Z
Half Round
Tapped Holes
Bearing Strap**

DSH/RS40, DSH/RS44, 22060SH Series

Forward Axle - Input / 44-2.25 Inv Spline

Yoke & Slinger	Series	Joint Angle	Style	Dim. A	Dim. B	Dim. C	Spicer P/N
127620	1610	35	X	5.00	1.88	5.31	5-4-9261-1X
127550	1710	23	Y	5.19	1.94	6.09	6-4-8451
127617	1710	30	X	5.19	1.94	6.19	6-4-8981-1X
127622	1760	30	X	5.25	1.94	7.09	6.3-4-5221-1X
127618	1760	30	Y	5.25	1.94	7.00	6.3-4-5221X
127621	1810	30	X	5.25	1.94	7.64	6.5-4-4571-1X
127619	1810	30	Y	5.25	1.94	7.55	6.5-4-4571X

Forward Axle - Output / 39-1.95 Inv Spline

Yoke & Slinger	Series	Joint Angle	Style	Dim. A	Dim. B	Dim. C	Vendor P/N
127638	1610	45	Y	6.00	1.88	5.31	5-4-9271X
127624	1710	45	Y	6.12	1.94	6.09	6-4-9001X
127558	1710	30	Y	5.25	1.94	6.09	6-4-9041X
128722	1710	39.5	X	6.12	1.94	6.19	6-4-9001-1X
128737	1710	30	X	5.25	1.94	6.19	6-4-9041-1X

Rear Axle - Pinion / 39-1.95 Inv Spline

Yoke & Slinger	Series	Joint Angle	Style	Dim. A	Dim. B	Dim. C	Spicer P/N
129164	1480	19	X	4.34	1.38	4.19	3-4-13081-1X
129166	1550	24.5	X	4.30	1.38	4.19	4-4-7571-1X
128720	1610	45	Y	6.00	1.88	5.31	5-4-9241X
128721	1610	22	Y	4.72	1.88	5.31	5-4-9251X
127415	1710	30	Y	5.25	1.94	6.09	6-4-9031X
127637	1710	45	Y	6.12	1.94	6.09	6-4-8991X
128745	1710	30	X	5.25	1.94	6.19	6-4-9031-1X
128746	1710	39.5	X	6.12	1.94	6.19	6-4-8991-1X

Oil Seal Installation Tools

This kit contains installation tools used for installing drive axle oil seals. Using these tools ensures proper installation of the seal. Failure to use these tools may result in an improperly installed or damaged seal.

Oil Seal Driver Installation Kit 217414

D-Input

Use 126917



126917

D-Output

Use 126917 and 128706

126917

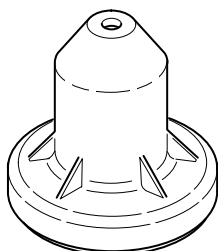

+



128706

R-Pinion

Use 126917

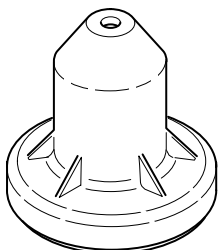

126917

Description	Part Number
Air Lockout Kit - Complete	510052
Air Lockout Repair Kit	510053
Axle Hsg Breather Kit	507162
Axle Hsg Hardware Kit - Thick Flange	512087
Axle Hsg Hardware Kit - Thin Flange	511600
Basic Overhaul Kits	
DSH40(P), DSH44(P)	510393
DDH40(P), DDH44(P)	510399
RSH40, RSH44, 22060SH	510398
RDH40, RDH44	510400
Bearing Kits	
DSH40(P), DSH44(P)	512812
DDH40(P), DDH44(P)	512800
RSH40, RSH44, 22060SH	512806
RDH40, RDH44	512805
Diff Carrier & Bearing Caps Kits	
DSH40, DSH44	510023
DSH40(P), DSH44(P)	510024
DDH40, DDH44	510027
DDH40(P), DDH44(P)	510028
RSH40, RSH44, 22060SH	510018
RDH40, RDH44	510017

Description	Part Number
Input Shaft Kit	510593
Oil Seal Driver Installation Kit	217414
Oil Seal Shim Kits	
Forward Axle	216224
Rear Axle	216225
Output Shaft Kit	216227
Ring Gear Nut & Bolt Kit	508652
Shift Fork & Compression Spring Kit	510870
Wheel Diff Case Kits	
DSH40(P), DSH44(P) - Ratios 2.64 to 3.25	508653
DSH40(P), DSH44(P) - Ratios 3.36 to 3.90	508654
DSH40(P), DSH44(P) - Ratios 4.11 to 4.88	508655
DSH40(P), DSH44(P) - Ratios 5.29 to 7.17	508656
DDH40(P), DDH44(P) - Ratios 2.64 to 3.25	508724
DDH40(P), DDH44(P) - Ratios 3.36 to 3.90	508725
DDH40(P), DDH44(P) - Ratios 4.11 to 4.88	508726
DDH40(P), DDH44(P) - Ratios 5.29 to 7.17	508727
Wheel Diff Side Gear Kit	510397
Wheel Diff Kit less Side Gears	510396

For spec'ing or service assistance, call 1-877-777-5360 or visit our website at www.dana.com

Dana Commercial Vehicle Products Group

3939 Technology Drive
Maumee, Ohio, USA 43537

www.dana.com



SPICER®

Drivetrain Products



SPICER[®]
DRIVETRAIN COMPONENTS



Pro Gear
AND TRANSMISSION

Dana DST40 - 3.9 Single Reduction Tandem Drive Axle

Pro Gear's Dana Single Reduction Tandem Drive High Performance Series Parts Manual to assist in identifying your Dana axle.

If you need any assistance identifying the correct axle unit for your truck and equipment, contact your Dana replacement part specialists at Pro Gear and Transmission.

Pro Gear and Transmission has same day shipping and 1000's of products in stock and ready to ship internationally for your next project.

For parts or service contact the Dana Axle specialists at Pro Gear & Transmission, Inc.

 CALL US

 EMAIL US

 VISIT MODEL PAGE

 VISIT ONLINE STORE

Pro Gear and Transmission, Inc | www.progearandtransmission.com | www.pgtruckparts.com
906 West Gore St, Orlando, FL, 32805 | +1 (877)-776-4600 | +1 (407)-872191 | parts@eprogear.com