



## **Meritor Axle Model RT-40-145 - RR-20-145 - Carrier B1-3200-E-1851**

Pro Gear parts and service manual for Meritor Axle Model RT-40-145 - RR-20-145 - Carrier B13200E1851 to assist you in identifying the correct configuration of your Meritor Axle. This Meritor B13200E1851 axle, is available and ready for international shipping. Call today!

If you need any assistance identifying the correct Meritor axle unit for your truck or equipment, contact your Meritor axle replacement specialists at Pro Gear and Transmission.

Pro Gear stocks every part for your Meritor axle RT40145 and RR20145. We have 1000's of products in shop that are ready to ship internationally for your next project.

For parts or service contact the Meritor specialists at Pro Gear & Transmission, Inc.

 CALL US

 EMAIL US

 VISIT MODEL PAGE

 VISIT ONLINE STORE

# MERITOR® 140, 141, 143, 144 AND 145 SERIES DRIVE AXLE PARTS CATALOG



**MERITOR**



# HOW TO USE THIS CATALOG

There are 51 basic carriers covered in this catalog:

3200-R-1500	3200-T-1814	3200-N-1860	3200-M-1885	3200-P-1914	3200-F-1982
3200-M-1547	3200-U-1815	3200-S-1865	3200-P-1888	3200-R-1916	3200-H-1984
3200-X-1558	3200-V-1816	3200-Z-1872	3200-R-1890	3200-S-1917	3200-J-1986
3200-L-1624	3200-W-1817	3200-A-1873	3200-D-1902	3200-T-1918	3200-K-1987
3200-G-1645	3200-C-1849	3200-B-1874	3200-E-1903	3200-Z-1924	3200-L-1988
3200-X-1662	3200-D-1850	3200-C-1875	3200-F-1904	3200-B-1978	3200-W-2051
3200-L-1676	3200-E-1851	3200-D-1876	3200-G-1905	3200-C-1979	
3200-M-1677	3200-F-1852	3200-E-1877	3200-H-1906	3200-D-1980	
3200-Q-1785	3200-G-1853	3200-G-1879	3200-M-1911	3200-E-1981	

Major assembly differences such as oil pumps, main diff. locks, etc. are indicated by the different assembly level numbers as well as the base carrier part number. The Axle Models-Carriers-Features Chart on Page 2 lists all the variations of the carriers covered in this book.

**Note:** The carriers listed in this catalog do **not** include yokes. A yoke is a major assembly difference, so a carrier sold with a yoke has a different assembly level number than the same carrier without the yoke.

The charts for carriers, output shafts, and axle housings include the following information:

- An exploded view of each assembly, keyed to the parts list.
- A description of each part.
- Parts that are sold as assemblies that include other parts.
- Which carriers or axle models the part is used on.
- The quantity of the part used on the carrier or axle.
- The part number of each part.
- Whether the part is available in a kit.

**Carrier Parts:** Determine which Chart and Figure (1 or 2) applies to your carrier by using the following sources of information:

- Identification tag installed on the carrier.
- Axle Models-Carrier-Features Chart.
- Pictures and descriptions of the carriers inside the front cover and at the beginning of Chart 1 and Chart 2.

**Output (Thru) Shafts:** This chart covers the output shafts for the forward axles of all tandems. Note that the output shaft assembly or its components are only sold as separate items. The output shaft is **not** included with the purchase of a carrier or housing.

**Housing Assemblies and Wheel End Parts:** This chart covers the housing assemblies and wheel end parts for all axles. The parts are listed according to axle models and the two wheel end series (L Series or R Series) that are used on 140, 141, 143, 144 and 145 series axles.

**Axle Shafts:** The axle shafts are grouped in sets (L.H. and R.H.) according to the axle models they are used on. Many axle shaft sets are used on more than one axle model. The axle shafts are also listed by part number with dimensions.

**Yokes and Flanges:** There are five charts that cover full round bearing yokes, wing bearing yokes, Easy Service yokes, RPL yokes and flanges. Each chart lists the yokes or flanges used on each axle model. The yokes and flanges are listed by dimension.

**Kits:** The first chart lists all the kits available for each axle model and carrier. Following that chart, the kits are listed in numerical order, and the contents of each kit is listed.

**Numerical Parts Index:** This lists every part number in the catalog along with the page(s) on which the part is listed.

# Rear Drive Axles

## Model Numbers and Designations - OLD STYLE



**NOTE 1:**

If a complete axle designation is not required, use the first seven positions of the model designation to identify the basic axle model.

**EXAMPLES OF BASIC AXLE MODELS:**

**RS 17 140** - Single Rear Drive, 17,000 lb., Single Speed, 15" Ring Gear, 140 Carrier Model.

**RT 48 380** - Tandem Drive Axle Set, 48,000 lb., Helical Double Reduction, 19.62" Ring Gear, 380 Carrier Model.

**RZ 60 164** - Tridem Drive Axle Set, 60,000 lb., Single Speed, Includes a 150 Series Forward Rear or First Axle and a 145 Series Tandem Axle Set as the Second and Third Axles.

**NOTE 2, FOR TRIDEM AXLES ONLY:**

For a Tridem Drive Axle Set (**RZ**), the number in the sixth position designates the carrier in the first axle. The number in the seventh position designates the carriers in the second and third axles.

**NOTE 3:**

Some axle designations or specifications do not have a hub type code.

# Rear Drive Axles

## Model Numbers and Designations - NEW STYLE



**FIGURE 1**  
**FORWARD CARRIERS OF TANDEM AXLES**  
 (USE WITH CHART 1)

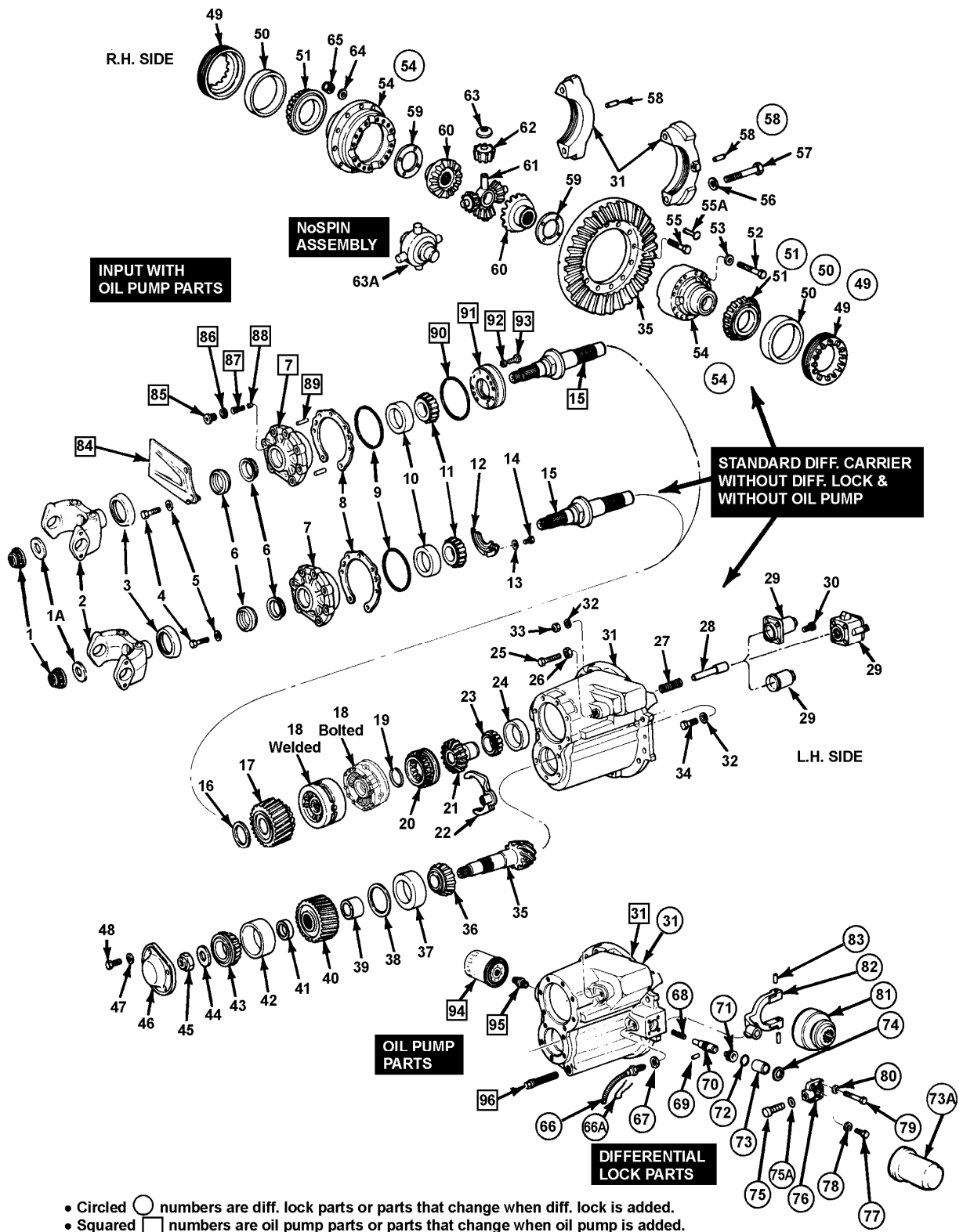

**FIGURE 2**  
**CARRIERS FOR SINGLE AXLES AND**  
**REAR OF TANDEM AXLES**  
 (USE WITH CHART 2)

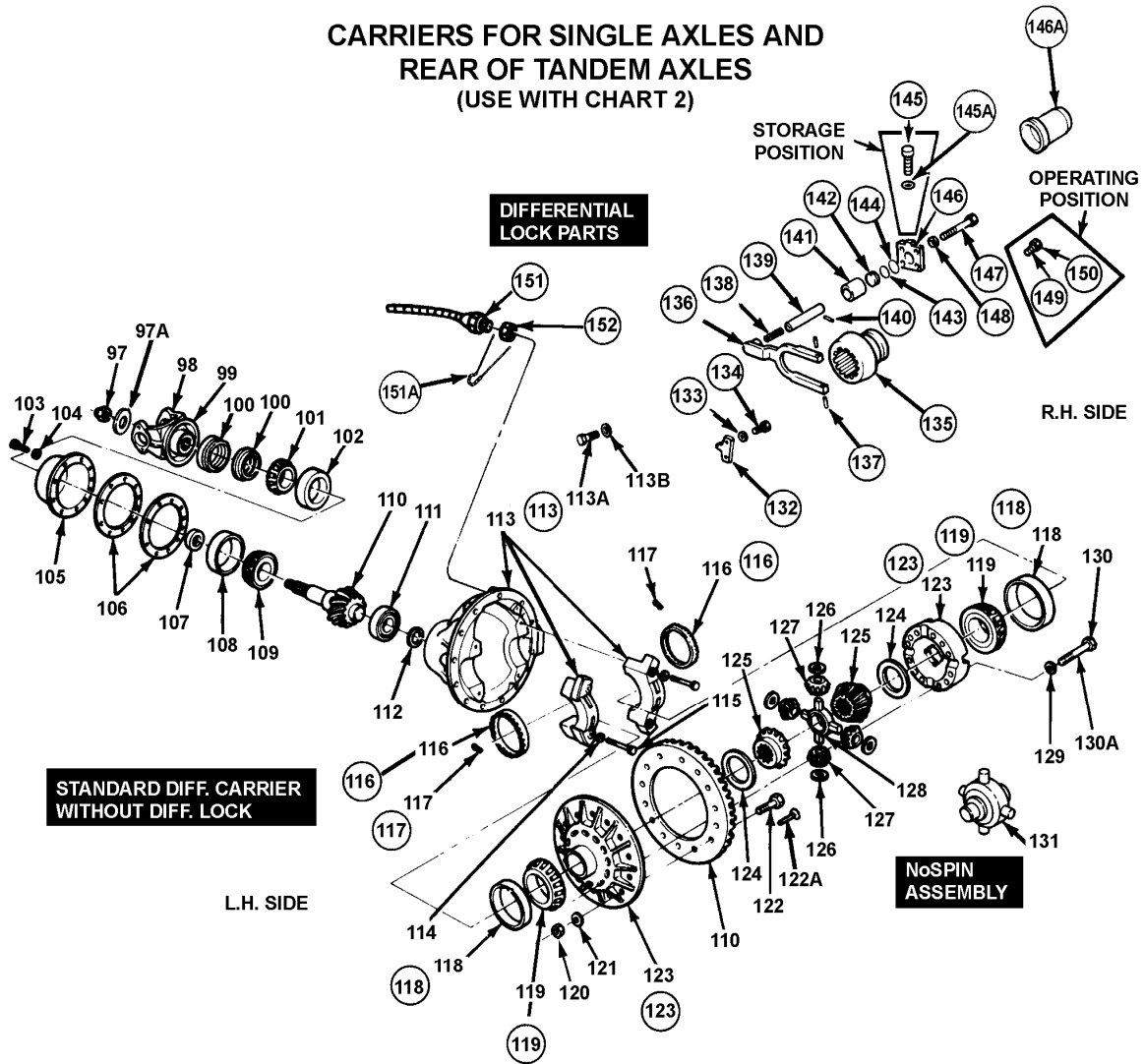

• Circled ○ numbers are diff. lock parts or parts that change when diff. lock is added.

**SUPPLEMENTAL DRAWING  
CARRIERS WITH INTERNAL A.B.S.**



**EXPLODED VIEW OF REVERSE AIR SHIFT UNIT**



• Circled  numbers are diff. lock parts or parts that change when diff. lock is added.



# TABLE OF CONTENTS

	<b>Page</b>
<b>Carriers &amp; Features of Current Axle Models.....</b>	<b>2</b>
<b>Forward Carriers of Tandem Axles.....</b>	<b>3</b>
<b>Carriers for Single Axles and Rears of Tandem Axles.....</b>	<b>10</b>
<b>Output (Thru) Shafts.....</b>	<b>20</b>
<b>Housing Assemblies and Wheel End Parts.....</b>	<b>21</b>
<b>Axle Shafts.....</b>	<b>22</b>
<b>Yokes and Flanges</b>	
Full Round Bearing Yokes.....	<b>27</b>
Wing Bearing Yokes.....	<b>28</b>
Easy Service Yokes.....	<b>29</b>
RPL Yokes.....	<b>30</b>
Companion Flanges.....	<b>31</b>
<b>Axle Model to Carrier to Kit Cross Reference.....</b>	<b>32</b>
<b>Service Kits.....</b>	<b>38</b>
<b>Numerical Parts Index.....</b>	<b>53</b>
<b>Warranty.....</b>	<b>60</b>

## CURRENT AXLE MODELS - CARRIERS - FEATURES

AXLE MODELS			CARRIERS	MAIN DIFF. LOCK	NO SPIN @ DIFF.	OIL PUMP	A.B.S.	AXLE SPLINE	RATIOS AVAIL.	STD. IAD SHIFT (UNLESS NOTED)			
RS-16-140 RS-17-140 (SINGLE AXLE)			A23-3200-M-1647					1.85" - 36	3.42 thru 7.17				
			B2-3200-L-1676					2.00" - 39					
RS-16-141 (SINGLE AXLE) RS-17-141 (SINGLE AXLE)			B11-3200-L-1676		●								
			B7-3200-S-1865										
RS-17-145 RS-19-145 (SINGLE AXLE)			B7-3200-L-1676						2.79 thru 3.21				
			B7-3200-S-1865						3.42 thru 7.17				
			B9-3200-L-1676		●					2.79 thru 3.21			
			B9-3200-S-1865		●					3.42 thru 7.17			
RS-17-144 RS-19-144 RS-21-145 (SINGLE AXLE)			B4-3200-L-1676					2.10" - 41	2.64 thru 3.21				
			B4-3200-S-1865						3.42 thru 7.17				
			B13200-G-1879	●						2.64 thru 7.17			
			B8-3200-L-1676		●					2.64 thru 3.21			
RT-34-145			B8-3200-S-1865		●				3.42 thru 7.17				
			Fwd	RD-17-145	B4-3200-G-1645					2.00" - 39	2.79 thru 7.17	REVERSE	
					A6-3200-B-1978		●						
			Rear	RR-17-145	A8-3200-B-1978		●						
B6-3200-F-1852					●								
A6-3200-H-1984					●	●							
A8-3200-H-1984		●			●								
RT-40-140			B7-3200-L-1676		●				2.79 thru 3.21				
			B7-3200-S-1865						3.42 thru 7.17				
			B9-3200-L-1676		●					2.79 thru 3.21			
			B9-3200-S-1865		●					3.42 thru 7.17			
MT-40-143			B4-3200-E-1851				●						
			Fwd	RD-20-140	A13200-B-1978					2.10" - 41	2.64 thru 7.17	REVERSE	
RT-40-140			B13200-G-1645										
			Rear	RR-20-140	B4-3200-S-1865								
			MT-40-143			A13200-B-1978							
						A13200-E-1981	●						
RT-34-144 RT-38-144 RT-40-145			A13200-C-1979 *										
			Fwd	MD-20-143	A13200-H-1984			●					
			Rear			MR-20-143M	A-3200-W-2051				2.64 thru 4.11		
						MR-20-143	B4-3200-L-1676					2.64 thru 3.21	
RT-34-144 RT-38-144 RT-40-145			B4-3200-S-1865						3.42 thru 7.17				
			B13200-M-1885 *							2.79 thru 7.17			
			Fwd	RD-17-144	A13200-B-1978						2.64 thru 7.17		
			Rear	RR-17-144 RR-19-144 RR-20-145	RD-19-144	B13200-G-1645							REVERSE
					RD-20-145	A13200-E-1981	●						
					A4-3200-B-1978		●						
					B13200-E-1903	●							REVERSE
					A13200-C-1979 *								
					B13200-S-1917 *					●			
					B13200-F-1852					●			
					RP-17-144	A13200-K-1987	●			●			
			RP-19-144	B13200-D-1902	●			●			REVERSE		
			Rear	RR-17-144 RR-19-144 RR-20-145	RP-20-145	A13200-H-1984				●			
					B13200-X-1662				●				
A4-3200-H-1984		●				●							
B13200-G-1853					●	●	●						
B4-3200-L-1676									2.64 thru 3.21				
B4-3200-S-1865									3.42 thru 7.17				
B13200-G-1879	●						2.64 thru 7.17						
B8-3200-L-1676		●					2.64 thru 3.21						
B8-3200-S-1865		●					3.42 thru 7.17						
B13200-M-1885 *							2.79 thru 7.17						
B13200-R-1916 *						●							
B13200-D-1850						●		2.64 thru 3.21					
B13200-E-1851						●		3.42 thru 7.17					
RT-44-145			A13200-D-1980						3.42 thru 5.86				
			Fwd	RD-22-145	A13200-F-1982	●							
			Rear			RP-22-145	A13200-J-1986			●			
						A13200-L-1988	●			●			
RT-44-145			B13200-T-1918	●			●			REVERSE			
			B13200-P-1914				●				REVERSE		
			B13200-A-1873			●							
			B13200-F-1904	●									
RT-44-145			B13200-Z-1924										

\* Indicates aluminum carrier housing. (Not available in 2.64 ratio.)

# CHART 1

## FORWARD CARRIERS OF TANDEM AXLES

(Use with Figure 1, Inside Front Cover)

### VISUAL IDENTIFICATION OF FORWARD CARRIERS

<p style="text-align: center;"><b>IAD SHIFTER:</b> BOLT ON FOR 1624, 1902, 1911, 1918 SCREW-IN FOR 1817, 1877, 1888, 1906, 1987 AND 1988 CARRIERS</p> <div style="text-align: center;">  </div> <p style="text-align: center;"><b>DIFF. LOCK:</b> BOLT-ON FOR 1624 AND 1817 CARRIERS SCREW-IN FOR 1877, 1888, 1902, 1906, 1911, 1918, 1987 AND 1988 CARRIERS</p> <p>FORWARD CARRIERS WITH IAD, DIFF. LOCK AND OIL PUMP: 3200-L-1624, 3200-W-1817, 3200-E-1877, 3200-P-1888, 3200-D-1902, 3200-H-1906, 3200-M-1911, 3200-T-1918, 3200-K-1987, 3200-L-1988</p>	<p style="text-align: center;"><b>IAD SHIFTER:</b> BOLT ON FOR 1677 AND 1903 SCREW-IN FOR 1815, 1875, 1890, 1905, 1981 AND 1982 CARRIERS</p> <div style="text-align: center;">  </div> <p style="text-align: center;"><b>DIFF. LOCK:</b> BOLT-ON FOR 1677 AND 1815 CARRIERS SCREW-IN FOR 1875, 1890, 1903, 1905, 1981 AND 1982 CARRIERS</p> <p>FORWARD CARRIERS WITH IAD AND DIFF. LOCK WITHOUT OIL PUMP 3200-M-1677, 3200-U-1815, 3200-C-1875, 3200-R-1890, 3200-E-1903, 3200-G-1905, 3200-E-1981, 3200-F-1982</p>
<p style="text-align: center;"><b>IAD SHIFTER:</b> BOLT-ON FOR 1662 AND 1914 SCREW-IN FOR 1816, 1853, 1876, 1894 AND 1986 CARRIERS</p> <div style="text-align: center;">  </div> <p style="text-align: center;"><b>NO DIFF. LOCK</b></p> <p>FORWARD CARRIERS WITH IAD AND OIL PUMP WITHOUT DIFF. LOCK: 3200-X-1662, 3200-V-1816, 3200-G-1853, 3200-D-1876, 3200-P-1914, 3200-H-1984, 3200-J-1986</p>	<p style="text-align: center;"><b>IAD SHIFTER:</b> BOLT ON FOR 1645 CARRIER SCREW-IN FOR 1814, 1852, 1860, 1874, 1917, 1978, 1979 AND 1980</p> <div style="text-align: center;">  </div> <p style="text-align: center;"><b>NO DIFF. LOCK</b></p> <p>FORWARD CARRIERS WITH IAD WITHOUT DIFF. LOCK OR OIL PUMP: 3200-G-1645, 3200-T-1814, 3200-F-1852, 3200-N-1860, 3200-B-1874, 3200-S-1917, 3200-B-1978, 3200-C-1979, 3200-D-1980</p>

THE FOLLOWING CARRIERS ARE EQUIPPED WITH A THRUST SCREW:

3200-A-1873, 3200-B-1874, 3200-C-1875, 3200-D-1876, 3200-E-1877, 3200-F-1904, 3200-G-1905,  
3200-H-1906, 3200-M-1911, 3200-T-1918, 3200-P-1914, 3200-D-1980, 3200-F-1982, 3200-J-1986, 3200-L-1988

THE FOLLOWING CARRIERS ARE MACHINED FOR INTERNAL ABS SENSORS:

3200-F-1852, 3200-G-1853, 3200-S-1917

# FORWARD CARRIERS OF TANDEM AXLES

ITEM	DESCRIPTION	REMARKS	CARRIER	QTY	PART NUMBER
1	Nut - input yoke and shaft	Included in KIT 2826	All after 11/93	1	40-X-1233
			Included in KIT 2637	All prior to 11/93	
1A	Washer - input shaft nut	Included in KIT 2826	All after 11/93	1	1229-N-1730
			Included in KIT 2637	All prior to 11/93	
4	Capscrew - input bearing cage		All	7	MS-212045-1
5	Washer - input bearing cage		All	7	1229-C-1511
6	Oil seal - input bearing cage	3" I.D.	All prior to 11/93	1	R945008
		3.25" I.D.	All after 11/93		A1-1205-X-2728
7, 10	Bearing cage and cup assy. - input		All w/o pump after 11/93	1	A-3226-V-1296
			All w/o pump prior to 11/93		A-3226-B-1224
			All with pump after 11/93		A-3226-D-1226
			All with pump prior to 11/93		A-3226-Z-1222
8	Shim - input bearing cage	.075mm/.003 inch .125mm/.005 inch .250mm/.010 inch	Included in KIT 2429	All	Use as req.
					2203-K-9241
					2203-L-9242
9	O-ring - input bearing cage		Less pump	1	5-X-1343 <sup>1</sup>
			With pump	1 ea.	5-X-1343 <sup>1</sup> 5-X-1034 <sup>1</sup>
10	Cup - input shaft bearing - outer		All	1	3920
11	Cone - input shaft bearing - outer		All after 11/93	1	JM-511945
			All prior to 11/93		JM-511946
12	Baffle - oil		All w/o pump	1	3221-P-1004
13	Washer - oil baffle		All w/o pump	3	1229-E-1669
14	Capscrew - oil baffle		All w/o pump	3	MS-208016-1
15, 1	Input shaft and nut assy.	Less pump 2"-39 spline	All prior to 11/93	1	KIT 2834 <sup>2</sup>
		Less pump 2.38"-46 spline	All after 11/93		A-3297-U-1347
	Input shaft, nut, ball assy.	2.38"-46 spline. With pump	All prior to 8/91		A-3297-T-1346
		Pump driven off flats on the input shaft. 2"-39 spline			KIT 2835 <sup>2</sup>
	Pump driven off splines on the input shaft. 2"-39 spline	All from 8/91 to 11/93		KIT 2833 <sup>2</sup>	
16	Thrust washer - helical drive gear		All	1	1229-S-4985
17	Helical gear and forward side gear		All	1	KIT 4007
18	Diff. case and pinion nest assy. - inter-axle	Bolted	1978, 1979, 1980, 1981, 1982, 1984, 1986, 1987, 1988 carriers after 10/98	1	A-3235-N-2380
		Welded	All except 1624 / prior to 10/98		A-3235-W-2025
		Bolted	1624 carrier only		KIT 2743
18A	Case halves and fastener hardware		For bolted version only.	1	A2-3235-N-2380
18B	Bolt		All after 10/98	8	MS210045A-1
18C	Washer				1229-K-1597
18D	Spider	Included in KIT 2420		1	3278-A-1119
18E	Pinion gear			4	2233-U-1035
18F	Pinion gear thrust washer				1229-T-1606
19	Snap-ring - inter-axle differential		All	1	2297-E-5335
20	Clutch collar - inter-axle diff.			1	3107-M-1183
21	Side gear - inter-axle diff.		All	1	2234-R-1188
22	Shift fork - inter-axle diff.		All	1	3296-Z-1326
23	Cone - rear side gear bearing		All	1	JLM-710949C
24	Cup - rear side gear bearing		All	1	JLM-710910
25	Adjusting screw - shift shaft		All	1	41-X-1208
26	Jam nut - adjusting screw		All	1	MN-312-1
27	Spring - shift shaft return		All except "reverse-air"	1	2258-U-411
28	Shift shaft - inter-axle differential		All except "reverse-air"	1	2244-K-1025
		Bolt-on style, Navistar only (reverse-air)	Included in KIT 2686 and KIT 2445		2244-D-1070
29	Shift assy. - inter-axle diff. air	Bolt-on style, Navistar only (reverse-air)	Included in KIT 2445	1	A-3261-R-1084
		Bolt-on style, serviced as assembly only			A-3261-L-350
		Screw-in style, serviced as assembly only			KIT 2825
29A	Snap ring	Bolt-on style, Navistar only	Included in KIT 2445	1	1229-P-4280
29B	Spring - shift	(reverse-air)		1	2258-E-1175

1 5-X-1034 is used in pump groove. 5-X-1343 is used in input cage.

2 Must change input yoke to 2.35"-46 spline. See Service Kit section for Bill of Material details.

# FORWARD CARRIERS OF TANDEM AXLES

ITEM	DESCRIPTION	REMARKS	CARRIER	QTY	PART NUMBER	
29C	Gasket - shift assembly	Bolt-on style, Navistar only (reverse-air)	Included in KIT 2445	1	2208-R-1058	
29D	Cover - shift assembly			1	3266-Q-1161	
29E	Washer - shift assembly capscrew			6	MWA-506	
29F	Capscrew - shift assembly short			2	41-X-1080	
29G	Capscrew - shift assembly to carrier			4	MS-206060-1	
29H	O-ring			1	5-X-1196	
29J	O-ring			1	5-X-1197	
29K	O-ring			1	5-X-1195	
29L	Housing - shift			1	3261-R-1084	
29M	Piston - shift assembly			1	2230-D-1096	
29N	Snap ring			1	1229-W-1245	
30	Capscrew - air shift assembly			1624, 1645, 1662, 1677	1	41-X-1209
31, 56, 57	Diff. carrier and cap Assy. Kit incl. carrier and cap Assy. and screw-in IAD shifter. Main diff. lock components included where applicable			With pump and thrust screw, w/o main diff. lock. Bolt-on reverse IAD shifter	3200-P-1914	1
		With pump, diff. lock and bolt-on IAD shifter	All 1624 except Navistar (Reverse-shift)		KIT 2705	
		With pump, main diff. lock and thrust screw. Bolt-on	3200-T-1918		A2-3200-T-1918	
		With pump, w/o diff. lock with bolt-on IAD shifter	All 1662 except Navistar (Reverse-shift)		KIT 2707 <sup>18</sup>	
		With pump, w/o diff. lock with screw-in and IAD shifter, with thrust screw	3200-D-1876, 3200-J-1986		A2-3200-J-1986	
		With pump, w/o diff. lock, with bolt-on IAD shifter and thrust screw	3200-X-1662 (Reverse-shift only)		A2-3200-X-1662	
		With pump, w/o diff. lock, with screw-in IAD shifter	3200-V-1816, 3200-H-1984		A2-3200-H-1984	
		With pump, w/o diff. lock, with screw-in IAD shifter, for use with internal ABS sensor	3200-G-1853		A2-3200-G-1853	
		With pump, with bolt-on diff. lock and IAD shifter, with thrust screw	3200-L-1624, 3200-D-1902 (Reverse-shift only)		A2-3200-D-1902	
			3200-M-1677, 3200-E-1903 (Reverse-shift only)		A2-3200-E-1903	
		With pump, with screw-in diff. lock and IAD shifter	3200-W-1817, 3200-P-1888, 3200-K-1987		A2-3200-K-1987	
			3200-E-1877, 3200-H-1906, 3200-L-1988		A2-3200-L-1988	
		Without pump and main diff. lock, Aluminum carrier	3200-N-1860, 3200-C-1979		A2-3200-C-1979	
		Without pump and main diff. lock, Aluminum carrier (for ABS)	3200-S-1917 (Reverse-shift only)		A2-3200-S-1917	
		Without pump or diff. lock for use with internal ABS sensor, screw-in IAD shifter	3200-F-1852		A2-3200-F-1852	
		Without pump or diff. lock, for use with bolt-on IAD shifter and thrust screw	3200-G-1645 (Reverse-shift only)		A2-3200-G-1645	
		Without pump or diff. lock, with bolt-on IAD shifter	All 1645 except Navistar (Reverse-shift)		KIT 2706	
		Without pump or diff. lock, with screw-in IAD shifter	3200-T-1814, 3200-B-1978		A2-3200-B-1978	
		Without pump or diff. lock, with screw-in IAD shifter and thrust screw	3200-B-1874, 3200-D-1980		A2-3200-D-1980	
		Without pump, with diff. lock and bolt-on IAD shifter	All 1677 except Navistar (Reverse-shift)		KIT 2704	
Without pump, with screw-in diff. lock and IAD shifter	3200-U-1815, 3200-R-1890, 3200-E-1981		A2-3200-E-1981			
	3200-C-1875, 3200-G-1905, 3200-F-1982		A2-3200-F-1982			

18 For replacement information, contact Information Services at 888-725-9355.

## FORWARD CARRIERS OF TANDEM AXLES

ITEM	DESCRIPTION	REMARKS	CARRIER	QTY	PART NUMBER	
32	Jam nut			1	40-X-1016	
34	Thrust screw			1	41-X-1371	
35, 44, 45	Drive gear, pinion and nut assembly	2.64 Ratio	Some models may not be available in all ratios	Use 1 as req.	B-41718-1 <sup>1</sup>	
		2.79 Ratio			A-41676-1 <sup>2</sup>	
		2.93 Ratio			A-41104-1	
		3.07 Ratio			A-41508-1	
		3.21 Ratio			A-41510-1	
		3.42 Ratio			B-41276-1	
		3.58 Ratio			B-41512-1	
		3.73 Ratio			B-41514-1	
		3.90 Ratio			B-41678-1 <sup>3</sup>	
		4.11 Ratio			B-41680-1 <sup>4</sup>	
		4.33 Ratio			B-41278-1	
		4.56 Ratio			B-41562-1	
		4.63 Ratio			B-41280-1	
		4.88 Ratio			B-41282-1	
		5.29 Ratio			B-41284-1	
		5.86 Ratio			B-41466-1	
		6.14 Ratio			A-41468-1	
6.43 Ratio	A-41470-1					
6.83 Ratio	A-41472-1					
7.17 Ratio	A-41474-1					
3.36 Ratio	B-42214-1	Amboid gearing to be used only if there is a rear/rear Amboid carrier.				
3.55 Ratio	B-42216-1					
3.70 Ratio	B-42218-1					
36	Cone - drive pinion inner bearing		All	1	H715334	
37	Cup - drive pinion inner bearing		All	1	H715311	
38	Shim - pinion inner bearing cup	.075mm/.003 inch	Included in KIT 1647 and KIT 2429	Use as req.	2203-F-2788	
		.125mm/.005 inch			2203-G-2789	
		.250mm/.010 inch			2203-H-2790	
39	Spacer - pinion bearing inner		All	1	1244-V-1764	
40	Gear - helical driven		All	1	3892-N-4902	
41	Spacer - pinion bearing (variable thickness)	5.30mm/.209 inch	Included in KIT 2396	All	Use 2 as req.	2203-D-9806
		5.33mm/.210 inch				2203-E-9807
		5.35mm/.211 inch				2203-F-9808
		5.38mm/.212 inch				2203-G-9809
		5.40mm/.213 inch				2203-H-9810
		5.50mm/.217 inch				2203-J-9812
		5.60mm/.220 inch				2203-K-9813
		5.70mm/.224 inch				2203-L-9814
		5.80mm/.228 inch				2203-M-9815
		5.90mm/.232 inch				2203-N-9816
		6.00mm/.236 inch				2203-P-9818
		6.10mm/.240 inch				2203-Q-9819
		6.13mm/.241 inch				2203-R-9820
		6.15mm/.242 inch				2203-S-9821
		6.18mm/.243 inch				2203-T-9822
6.20mm/.244 inch	2203-U-9823					
42	Cup - drive pinion outer bearing		All	1	72487	
43	Cone - drive pinion outer bearing		All	1	72212C	
44	Washer - drive pinion nut	Use with 40-X-1145	145 series only	1	1229-G-4063 <sup>5</sup>	
		Use with 40-X-1233	140, 144, 145 series only		1229-W-4521 <sup>7</sup>	
45	Nut - drive pinion	M45x1.5-6H thd.	140, 144, 145 series only	1	40-X-1233 <sup>7</sup>	
		M50x2-6H thd.	145 series only		40-X-1145 <sup>5</sup>	
46	Cover - drive pinion		All	1	3266-C-1095	
47	Washer - drive pinion cover		All	5	1229-K-1597	
48	Capscrew - drive pinion cover		All except aluminum	5	MS-210020-1	
			Aluminum only		MS-210030-1	
49	Adjusting ring - diff. bearing	L.H.	All with diff. lock	1	2214-Y-1039	
		L.H. and R.H.	All without diff. lock		2	2214-C-1095
		R.H.	All with diff. lock		1	2214-C-1095
50	Cup - diff. bearing	L.H.	All with diff. lock	1	1228-L-1130	
		L.H. and R.H.	All without diff. lock		2	JM-716610
		R.H.	All with diff. lock		1	JM-716610

1 Not available in the aluminum carrier.

3 Replaces B-41516-1 (3.91 ratio)

5 Used in special 145 applications only.

7 Included in KIT 2638.

2 Replaces A-39908-3 (2.80 ratio)

4 Replaces B-41518-1 (4.10 ratio)

6 2.10"-41 spline

## FORWARD CARRIERS OF TANDEM AXLES

ITEM	DESCRIPTION	REMARKS	CARRIER	QTY	PART NUMBER
51	Cone - diff. bearing	L.H.	All with diff. lock	1	A-1228-L-1130
		L.H. and R.H.	All without diff. lock	2	JM-716649
		R.H.	All with diff. lock	1	JM-716649
52	Capscrew - main diff. case	Included in KIT 2819	All	16	41-X-1327
53	Washer - main diff. case		All	16	1229-D-4632
54, 52, 53	Case assy. standard - main diff.	Ratios 2.64, 2.79, 2.93	With diff. lock	Use 1 as req.	A2-3235-V-1920
		Ratios 3.07, 3.21, 3.36	Without diff. lock		A8-3235-V-1920
			With diff. lock		A2-3235-S-1839
		Ratios 3.42, 3.55, 3.58, 3.70, 3.73, 3.90, 4.11 (All except RT44145 tandem)	Without diff. lock		A8-3235-S-1839
			With diff. lock		A2-3235-U-1841
		Ratios 3.42, 3.58, 3.73, 3.90, 4.11 (RT44145 tandem only)	Without diff. lock		A8-3235-U-1841
			With diff. lock		KIT 2664
		Ratios 4.30, 4.56, 4.63, 4.88, 5.29, 5.86, 6.14, 6.43, 6.83, 7.17 (RT44145 tandem only)	Without diff. lock		KIT 2665
			With diff. lock		KIT 2648
		Ratios 4.30, 4.56, 4.63, 4.88, 5.29, 5.86, 6.14, 6.43, 6.83, 7.17 (Except RT44145 tandem)	Without diff. lock		KIT 2647
With diff. lock	A2-3235-W-1843				
54, 52, 53, 204, 205, 206	Case assy. with ABS tubes - main diff.	Ratios 3.07, 3.21		Use 1 as req.	A2-3235-M-2171 <sup>5</sup>
		Ratios 3.42, 3.58, 3.73, 3.90, 4.11 (All except RT44145 tandem)			A3-3235-M-2171 <sup>6</sup>
					A2-3235-L-2170 <sup>9</sup>
		Ratios 4.30, 4.56, 4.63, 4.88, 5.29, 5.86, 6.14, 6.43, 6.83, 7.17 (Except RT44145 tandem)			A3-3235-L-2170 <sup>6</sup>
					A3-3235-J-2168 <sup>6</sup>
		A2-3235-J-2168 <sup>5</sup>			
54, 52, 53, 59, 60, 62, 63	Case & nest assy. standard - main diff.	Ratios 2.64, 2.79, 2.93	With diff. lock	Use 1 as req.	A3-3235-V-1920 <sup>6</sup>
			Without diff. lock		A9-3235-V-1920 <sup>6</sup>
		Ratios 3.07, 3.21, 3.36	With diff. lock		A10-3235-V-1920 <sup>5</sup>
			Without diff. lock		A3-3235-S-1839 <sup>9</sup>
		Ratios 3.42, 3.55, 3.58, 3.70, 3.73, 3.90, 4.11 (All except RT44145 tandem)	With diff. lock		A10-3235-S-1839 <sup>5</sup>
			Without diff. lock		A9-3235-S-1839 <sup>6</sup>
		Ratios 3.42, 3.58, 3.73, 3.90, 4.11 (RT44145 tandem only)	With diff. lock		A3-3235-U-1841 <sup>6</sup>
			Without diff. lock		A10-3235-U-1841 <sup>5</sup>
		Ratios 4.30, 4.56, 4.63, 4.88, 5.29, 5.86, 6.14, 6.43, 6.83, 7.17 (All except RT44145 tandem)	With diff. lock		A9-3235-U-1841 <sup>6</sup>
			Without diff. lock		A11-3235-D-2188 <sup>6</sup>
		Ratios 4.30, 4.56, 4.63, 4.88, 5.29, 5.86, 6.14, 6.43, 6.83, 7.17 (RT44145 tandem only)	With diff. lock		A10-3235-D-2188 <sup>6</sup>
			Without diff. lock		A3-3235-W-1843 <sup>6</sup>
					A10-3235-W-1843 <sup>5</sup>
		A9-3235-W-1843 <sup>6</sup>			
		A11-3235-T-2152 <sup>6</sup>			
		A10-3235-T-2152 <sup>6</sup>			
54, 52, 53, 59, 60, 62, 63, 204, 205, 206	Case & nest assy. with ABS tubes - main diff.	Ratios 3.07, 3.21		Use 1 as req.	A4-3235-M-2171 <sup>5</sup>
		Ratios 3.42, 3.58, 3.73, 3.90, 4.11 (All except RT44145 tandem)			A5-3235-M-2171 <sup>6</sup>
					A5-3235-L-2170 <sup>6</sup>
		Ratios 4.30, 4.56, 4.63, 4.88, 5.29, 5.86, 6.14, 6.43, 6.83, 7.17 (All except RT44145 tandem)			A4-3235-L-2170 <sup>5</sup>
					A5-3235-J-2168 <sup>6</sup>
		A4-3235-J-2168 <sup>5</sup>			
54, 52, 53, 63A	Case & nest assy. with NoSPIN diff. - main diff.	Ratios 2.64, 2.79, 2.93		Use 1 as req.	A11-3235-V-1920 <sup>6</sup>
		Ratios 3.07, 3.21			A12-3235-V-1920 <sup>5</sup>
					A12-3235-S-1839 <sup>5</sup>
		Ratios 3.42, 3.58, 3.73, 3.90, 4.11 (All except RT44145 tandem)			A11-3235-S-1839 <sup>6</sup>
					A11-3235-U-1841 <sup>6</sup>
		Ratios 3.42, 3.58, 3.73, 3.90, 4.11 (RT44145 tandem only)			A12-3235-U-1841 <sup>9</sup>
					A4-3235-D-2188 <sup>6</sup>
		Ratios 4.30, 4.56, 4.63, 4.88, 5.29, 5.86, 6.14, 6.43, 6.83, 7.17 (All except RT44145 tandem)			A12-3235-W-1843 <sup>5</sup>
	A11-3235-W-1843 <sup>6</sup>				

5 2.00"-39 spline  
9 2.00"-39 spline. No longer available.

6 2.10"-41 spline

# FORWARD CARRIERS OF TANDEM AXLES

ITEM	DESCRIPTION	REMARKS	CARRIER	QTY	PART NUMBER
54, 52, 53, 63A (Cont)	Case & nest assy. with NoSPIN diff. - main diff.	Ratios 4.30, 4.56, 4.63, 4.88, 5.29, 5.86, 6.14, 6.43, 6.83, 7.17 (RT44145 tandem only)		Use 1 as req.	A4-3235-T-2152 <sup>5</sup>
55	Bolt - gear to case	Included in KIT 2317		12	41-X-1216
55A	Rivet - gear to diff. case	For service, rivets can be replaced with KIT 2317		12	RV-71016
56	Washer - diff. bearing cap		All	4	42-X-1021
57	Capscrew - diff. bearing cap		All except aluminum	4	MS-220120-1
			Aluminum only		41-X-1365
58	Pin - adjusting ring lock	L.H.	All with diff. lock	1	1246-P-1134
		L.H. and R.H.	All without diff. lock	2	1199-R-2176
		R.H.	All with diff. lock	1	1199-R-2176
59	Thrust washer - side gear (Items 59-63 are not used in NoSPIN models. See Item 63A)		All after 11/93	2	1229-V-4624
			All prior to 11/93		1229-X-4522
60	Side gear - differential (Items 59-63 are not used in NoSPIN models. See Item 63A)	Included in KIT 2310	All 40,000 lb. tandems after 11/93	2	2234-U-1269 <sup>6</sup>
		Included in KIT 2389	All 34,000 lb. tandems after 11/93		2234-V-1270 <sup>5</sup>
		Included in KIT 2696	RT44145 tandems after 11/93		2234-X-1272 <sup>6</sup>
			All 40,000 lb. tandems prior to 11/93		KIT 2759 <sup>6</sup>
			All 34,000 lb. tandems prior to 11/93		KIT 2758 <sup>5</sup>
			RT44145 tandems prior to 12/92		KIT 2696 <sup>6</sup>
			RT44145 tandems from 1/93 to 11/93		KIT 2760 <sup>6</sup>
61	Spider - differential (cross) (Items 59-63 are not used in NoSPIN models. See Item 63A)	Included in KIT 2696	All exc 44,000 lb. tandems 44,000 lb. tandems only	1	3278-S-305 3278-Y-1117F
62	Gear - differential pinion (Items 59-63 are not used in NoSPIN models. See Item 63A)		All axles except RT44145 tandems produced after 1/93 RT44145 tandems produced after 1/93	4	2233-J-1024 2233-X-1116
63	Thrust washer - diff. pinion (Items 59-63 are not used in NoSPIN models. See Item 63A)			4	1229-R-1032
63A	NoSPIN diff. nest	Serviced as assembly only. Replaces items 59-63.	All 34,000 lb. capacity tandems All 40,000 & 44,000 lb. capacity tandems	1	A-3230-U-1035 <sup>5</sup> A-3230-T-1034 <sup>6</sup>
64	Washer - gear to diff. case	Included in KIT 2317	All	12	1229-U-1503
65	Nut - gear to diff. case		All	12	40-X-1182

**Note: The following parts are used only on forward carriers with main differential lock.**

66	Sensor/switch - main diff. lock	Included in KIT 4455		1	3237-W-1167
66A	Clip - sensor/switch			1	2257-M-1235
66B	Plug - DCDL switchport (non shown)	Non-DCDL applications only			41-X-1022
67	Lock nut - sensor/switch		All prior to 11/93	1	1227-P-1056
68	Spring - main diff. lock		All after 11/93	1	2258-N-1262
			All prior to 11/93		2258-L-714
69	Roll pin - spring retaining			1	43-X-1006
70	Shift shaft - main diff. lock	Not Threaded for fork	All after 11/93	1	KIT 2824
		Threaded for fork	All prior to 11/93		2244-L-1026
71	Piston - main diff. lock		All after 11/93	1	2230-T-1190
			All prior to 11/93		2230-N-170
72	O-ring piston		All after 11/93	1	5-X-1198
			All prior to 11/93		5-X-1153
73	Tube - air cylinder		All prior to 11/93	1	3196-F-32
73A	Air cylinder assembly - screw-in		All after 11/93	1	3261-A-1067
73B	Plug - screw-in DCDL cylinder hole (not shown)	Non-DCDL applications only			1250-U-1217
74	Gasket - air cylinder cover			1	2208-H-944
75	Capscrew - manual engaging		All prior to 11/93	1	41-X-1333
			All after 11/93		41-X-1368
75A	O-ring - manual engaging capscrew			1	5-X-521
76	Cover - air cylinder		Prior to 11/93	1	3266-F-1020
77	Plug - air cylinder cover		Prior to 11/93	1	MS-210016-1

5 2.00"-39 spline

6 2.10"-41 spline



## FORWARD CARRIERS OF TANDEM AXLES

ITEM	DESCRIPTION	REMARKS	CARRIER	QTY	PART NUMBER
78	Gasket - plug		Prior to 11/93	1	2208-L-1000
79	Capscrew - air cylinder cover			4	41-X-1364
80	Washer - air cylinder cover			4	MWA-506
81	Clutch collar			1	3107-D-1018
82	Shift fork	Not threaded	All after 11/93	1	3296-Z-1170
		Threaded	All prior to 11/93		3296-W-1167 <sup>10</sup>
83	Pin - shift fork	Old 3 piece design		2	43-X-1007

**Note: The following parts are used only on forward carriers with oil pump.**

84	Shield - filter			1	3280-Z-8398
85	Plug - oil pressure relief valve	No longer required as of 5/97		1	1250-N-1080 <sup>11</sup>
86	Washer - plug			1	1229-F-4062
87	Spring - oil pressure relief valve			1	2258-Z-1118
88	Pressure relief valve - oil			1	2297-U-5273
89	Input cage to oil pump dowels	No longer used		2	1246-M-1131
90	O-ring, oil pump			1	5-X-1034
91	Oil pump assembly	Serviced as assembly only	Pump driven off flats on input shaft	1	KIT 2835 <sup>2</sup>
			Pump driven off splines on input shaft		A-3303-P-1030
92	Washer - oil pump			6	1229-E-1669
93	Capscrew - oil pump			6	MS-208045-1
94	Oil filter			1	3280-V-8394
95	Adapter - oil filter			1	2297-Z-5278
96	Screen and plumb assy. - oil filter			1	A-2297-D-5334

**Note: The following parts are used only on forward carriers with internally mounted anti-lock brake system sensors.**

200	Wave washer			2	2258-U-1243
201	Snap ring			2	1229-U-4519
202	Snap ring			2	1229-B-4422
203	Sensor assembly			2	SA1-3280-U-8861
204	Sensor drive tube	39 Spline	Use KIT 2511	2	3216-S-4361
		41 Spline	Use KIT 2512		3216-Q-4359
205	Washer tube spacing			2	42-X-1248
206	Snap ring tube retaining			2	1229-H-4428

2 Must change input yoke to 2.35"-46 spline.

10 Replaced old three piece design (3296-N-1080)

11 Pressure relief plug eliminated. The relief valve and spring are now sandwiched between the pump and input cage before the pump is assembled to the cage.

## CHART 2

### CARRIERS FOR SINGLE AXLES AND REARS OF TANDEM AXLES

(Use with Figure 2, Inside Front Cover)

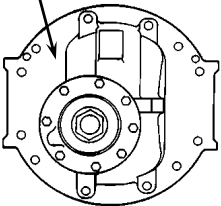
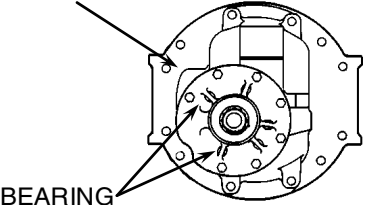
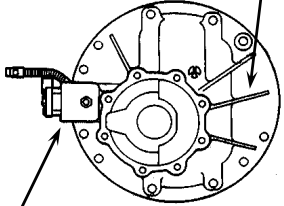
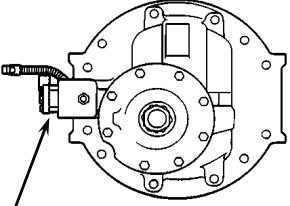
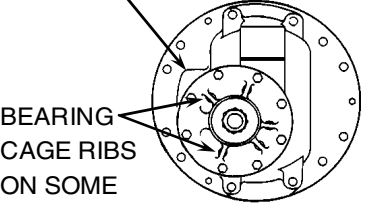
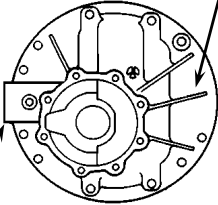
<b>VISUAL IDENTIFICATION OF REAR CARRIERS</b>		
<p style="text-align: center;">NO BULGE</p>  <p style="text-align: center;">REAR CARRIERS WITHOUT DIFF. LOCK</p> <p style="text-align: center;">3200-Q-1785 3200-C-1849 3200-E-1851 3200-S-1865 3200-A-1873 3200-Z-1924</p>	<p style="text-align: center;">BULGE</p>  <p style="text-align: center;">BEARING CAGE RIBS ON SOME MODELS</p> <p style="text-align: center;">REAR CARRIER WITHOUT DIFF. LOCK</p> <p style="text-align: center;">3200-M-1547</p>	<p style="text-align: center;">RIBS</p>  <p style="text-align: center;">DIFF. LOCK</p> <p style="text-align: center;">REAR CARRIER WITH DIFF. LOCK</p> <p style="text-align: center;">3200-M-1547</p>
<p style="text-align: center;">DIFF. LOCK</p>  <p style="text-align: center;">REAR CARRIERS WITH DIFF. LOCK</p> <p style="text-align: center;">3200-X-1558 3200-C-1849 3200-E-1851 3200-S-1865 3200-A-1873</p>	<p style="text-align: center;">BULGE</p>  <p style="text-align: center;">BEARING CAGE RIBS ON SOME MODELS</p> <p style="text-align: center;">REAR CARRIER WITHOUT DIFF. LOCK</p> <p style="text-align: center;">3200-L-1676 3200-M-1885</p>	<p style="text-align: center;">RIBS</p>  <p style="text-align: center;">NO DIFF. LOCK</p> <p style="text-align: center;">REAR CARRIER WITHOUT DIFF. LOCK</p> <p style="text-align: center;">3200-R-1500</p>

THE FOLLOWING CARRIERS ARE EQUIPPED WITH A THRUST SCREW:

3200-Z-1872, 3200-A-1873, 3200-F-1904, 3200-Z-1924

THE FOLLOWING CARRIERS ARE MACHINED FOR INTERNAL ABS SENSORS:

3200-D-1850, 3200E-1851, 3200-Z-1924

3200-W-2051 CARRIER (not pictured) IS EQUIPPED WITH A THRUST SCREW,  
HAS INTEGRAL PINION BEARING CAGE AND IS NOT AVAILABLE WITH DIFF. LOCK.



# CARRIERS FOR SINGLE AXLES AND REARS OF TANDEM AXLES

ITEM	DESCRIPTION	REMARKS	CARRIER	QTY	PART NUMBER	
107 (Cont)	Spacer - pinion bearing	8.35mm/.329 inch	Included in KIT 2321	RS17140 only	Use 2 as req.	2203-V-9486
		8.38mm/.330 inch				2203-W-9487
		8.40mm/.331 inch				2203-X-9488
		8.43mm/.332 inch				2203-Y-9489
		8.45mm/.333 inch				2203-Z-9490
		8.58mm/.338 inch				2203-A-9491
		8.70mm/.343 inch				2203-B-9492
		8.73mm/.344 inch				2203-C-9493
		8.75mm/.345 inch				2203-D-9494
		8.78mm/.346 inch				2203-E-9495
8.80mm/.347 inch	2203-F-9496					
107A	Spacer - pinion bearing		3200-W-2051 only	1	1244-F-2346	
108	Cup - drive pinion inner bearing	Amboid series	3200-W-2051	1	H715311	
			All except RS17140 and 3200-W-2051		72487	
			RS17140 only		55437	
109	Cone - drive pinion inner bearing	Amboid series	3200-W-2051	1	H715334	
			All except RS17140 and 3200-W-2051		72212C	
			RS17140 only		55200C	
110, 97, 97A	Drive gear, pinion and nut assy	Input spline size 2.00" dia. - 39 splines. Original small pitch dia. ring gear. New style will not fit in this carrier.	3200-Q-1785	Use 1 as req.	B-41530-1	
					B-41532-1	
					B-41534-1	
					B-41536-1	
					B-41538-1	
					Use 4.33 Ratio	
					B-41540-1	
					B-41542-1	
					B-41544-1	
					B-41546-1	
					B-41548-1	
					B-41550-1	
					B-41552-1	
					B-41554-1	
					B-41556-1	
					B-41558-1	
		B-41560-1 <sup>18</sup>				
		B-41716-1 <sup>11</sup>				
		Input spline size 2.00" dia. - 39 splines. New larger pitch diameter gearing.	3200-R-1500, 3200-X-1558, 3200-L-1676, 3200-M-1885, 3200-Z-1872, 3200-G-1879, 3200-F-1904		A-41682-1 <sup>11</sup>	
					A-41158-1	
					A-41494-1	
					A-41496-1	
					B-42120-1	
					A-42172-1	
					A-42200-1	
					A-42202-1	
					A-42204-1	
					B-42206-1	
		B-42180-1 <sup>16</sup>				
		Input spline size 2.00" dia. - 39 splines. Amboid series axles.	3200-W-2051		A-42128-1	
					B-41164-1	
					B-41498-1	
					A-41842-1 <sup>12</sup>	
B-41500-1						
B-41684-1 <sup>13</sup>						
A-41830-1 <sup>12</sup>						
A-41802-1 <sup>12</sup>						
B-41686-1 <sup>14</sup>						
B-41266-1						
Input spline size 2.00" dia. - 39 splines. New larger pitch diameter gearing. For 4.56 ratio use B-41542-1	All except RS16140, RS17140, 3200-Q-1785 and 3200-W-2051 carriers.		A-41654-1 <sup>15</sup>			
			B-41268-1			
			A-41672-1 <sup>12</sup>			
			B-41270-1			
			A-41714-1 <sup>12</sup>			
3.42 Ratio						
3.58 Ratio						
3.73 Ratio						
3.90 Ratio						
3.91 Ratio						
4.10 Ratio						
4.11 Ratio						
4.33 Ratio						
4.63 Ratio						
4.88 Ratio						

1 Not available in the aluminum carrier.

12 Coach quality gearing

14 Replaces B-41504-1 (4.10 ratio)

16 No longer available.

11 Replaces A-39910-1 (2.80 ratio)

13 Replaces B-41502-1 (3.91 ratio)

15 Coach quality gearing. 4.33 coach quality uses diff. case for 3.42 - 4.11.

18 For replacement information, contact Information Services at 888-725-9355.

# CARRIERS FOR SINGLE AXLES AND REARS OF TANDEM AXLES

ITEM	DESCRIPTION	REMARKS	CARRIER	QTY	PART NUMBER	
110, 97, 97A (Cont)	Drive gear, pinion and nut assy	5.13 Ratio	All except RS16140, RS17140, 3200-Q-1785 and 3200-W-2051 carriers.	Use 1 as req.	A-41652-1 <sup>12</sup>	
		5.29 Ratio			A-41272-1	
		5.57 Ratio			A-42272-1 <sup>12</sup>	
		5.86 Ratio			B-41274-1	
		6.14 Ratio			A-41304-1	
		6.43 Ratio			A-42086-1 <sup>12</sup>	
		6.83 Ratio			A-42464-1 <sup>12</sup>	
		7.17 Ratio			B-41456-1	
		3.42 Ratio			RS16140, RS17140	A-41164-3
		3.58 Ratio				
		3.73 Ratio	A-41500-3			
		3.90 Ratio	A-41684-3 <sup>17</sup>			
		4.11 Ratio	A-41686-3 <sup>16</sup>			
		4.33 Ratio	A-41266-3			
		4.56 Ratio	B-41542-3			
		4.88 Ratio	A-41270-3			
		5.13 Ratio	A-41272-3 <sup>16</sup>			
		5.29 Ratio	A-41274-3 <sup>16</sup>			
		5.57 Ratio	A-41304-3			
		5.86 Ratio	A-41456-3			
6.43 Ratio	A-41460-3					
6.83 Ratio	A-41462-3 <sup>16</sup>					
7.17 Ratio	A-41464-3 <sup>16</sup>					
111	Bearing - drive pinion spigot		All	1	1228-F-552	
112	Snap ring - drive pinion bearing		All	1	1229-A-1301	
113, 114, 115	Diff. carrier and cap assy.	Original design	3200-R-1500	1	A2-3200-R-1500	
		Without main diff. lock	3200-M-1547 (3.91 and 4.10 Ratios)		KIT 2729 <sup>18</sup>	
			All other ratios		KIT 2730	
			1676 (all ratios)		A2-3200-L-1676	
			1785, 1865 (3.42 - 7.17 ratios)		A2-3200-S-1865	
		With screw-in main diff. lock	3200-G-1879		A2-3200-G-1879	
		With screw-in main diff. lock and thrust screw	1904 (all ratios)		A2-3200-F-1904	
		Without main diff. lock, with thrust screw	1873 (3.42 - 7.17 ratios)		A2-3200-A-1873	
		Without main diff. lock, with internal ABS sensor	1850 (3.07 & 3.21 ratios)		A2-3200-D-1850	
			1851 (3.42 - 7.17 ratios)		A2-3200-E-1851	
		Without main diff. lock, aluminum carrier	3200-M-1885 (aluminum version of 1676 carrier)		A2-3200-M-1885	
			3200-C-1849 (aluminum version of 1865 carrier)		A2-3200-C-1849	
		Without main diff. lock, with thrust screw with internal ABS sensor	3200-Z-1924		A2-3200-Z-1924	
Amboid series drive axles	3200-W-2051	A2-3200-W-2051				
113A	Thrust screw	Included in KIT 4766	3200-W-2051	1	10-X-1710	
			All except 3200-W-2051		41-X-1371	
113B	Jam nut – thrust screw			1	40-X-1016	
113C	Thrust block	Included in KIT 4766	3200-W-2051 only	1	2297-P-8336	
114	Washer - differential bearing cap		All	4	42-X-1021	
115	Capscrew - differential bearing cap		All except aluminum	4	MS-220120-1	
			Aluminum only		41-X-1365	
116	Adjusting ring	L.H. - small	1547, 1558, 1879, 1904	1	2214-C-1095	
		R.H. - small			2214-Y-1039	
		L.H. and R.H.	3200-R-1500		2	2214-L-272
			All except 1500, 1547, 1558 3200-E-1851			2214-C-1095 2214-U-1139
117	Adjusting ring lock	L.H. and R.H. Diff. lock	1547, 1676, 1785, 1865	1	KIT 4284	
		L.H. and R.H. Non diff lock	1558, 1879, 1904		KIT 4284	
		L.H. only	3200-R-1500		1199-R-2176	
		R.H. see 132, 133 and 134				

12 Coach quality gearing  
17 Replaces A-41502-3 (3.91 ratio)

16 No longer available.  
18 For replacement information, contact Information Services at 888-725-9355.

# CARRIERS FOR SINGLE AXLES AND REARS OF TANDEM AXLES

ITEM	DESCRIPTION	REMARKS	CARRIER	QTY	PART NUMBER	
118	Cup - diff. ring	L.H. only	1547, 1558, 1879, 1904	1	JM-716610	
		R.H. only		1	1228-L-1130	
		L.H. and R.H.	1676, 1785, 1865, 1873, 2051	2	JM-716610	
				3200-R-1500	A1-1228-H-606 <sup>10</sup>	
118A	Adhesive - diff. bearing cup			1	2297-T-4180	
119	Cone - diff. bearing	L.H. only	1547, 1558, 1879, 1904	1	JM-716649	
		R.H. only		A-1228-L-1130		
		L.H. and R.H.	1676, 1785, 1865, 1873, 2051	2	JM-716649	
				3200-R-1500	A1-1228-H-606 <sup>10</sup>	
120	Nut - gear to differential case	Included in KIT 2317	All	12	40-X-1182	
121	Washer - gear to differential case			12	1229-U-1503	
122	Bolt - differential case to gear			12	41-X-1216	
122A	Rivet - gear to differential	For service, rivets can be replaced with KIT 2317	All	12	RV-71016	
123, 129, 130	Case assy - main diff.	Ratios 2.64, 2.79, 2.93	With diff. lock	1558, 1879	Use 1 as req.	A2-3235-V-1920
				Without diff. lock		1676, 1885, 2051
		Ratios 3.07, 3.08, 3.21, 3.36	With diff. lock	1558, 1879	A2-3235-S-1839	
				A12-3200-R-1500	A2-3235-Y-1741 <sup>16</sup>	
		Without diff. lock	1676, 1885, 2051	A8-3235-S-1839		
			3200-M-1547 except 1.85"-36 spline	A-3235-S-1839		
		Ratios 3.42, 3.55, 3.58, 3.70, 3.73, 3.90, 3.91, 4.10, 4.11 (Except 44,000 lb tandem axles) Note: 4.33 ratio for coach quality gearing also uses this std. diff. case.	With diff. lock	1558, 1849, 1879, 1904	A2-3235-U-1841	
				A12-3200-R-1500	A6-3235-C-1719	
		Without diff. lock	3200-M-1547 except 1.85"-36 spline	A-3235-U-1841		
			RS16140, RS17140, 3200-M-1547 (1.85"-36 spline)	A-3235-N-1938		
		3200-R-1500	A13-3235-C-1719 <sup>6</sup>			
			1676, 1785, 1865, 1885, 2051	A8-3235-U-1841		
		Ratios 3.42, 3.58, 3.73, 3.90, 3.91, 4.10, 4.11 (44,000 lb tandem axles only)	With diff. lock	1872 and 1904	A2-3235-D-2188	
				All others	KIT 2664	
		Without diff. lock	1873	A-3235-D-2188		
			All others	KIT 2665		
		Ratios 4.30, 4.33, 4.56, 4.63, 4.88, 5.13, 5.29, 5.57, 5.86, 6.14, 6.43, 6.83, 7.17 (Except 44,000 lb. tandem axles) Note: 4.33 ratio for coach quality gearing use diff. case for ratios 3.42-4.11	With diff. lock	1558, 1849, 1879, 1904	A2-3235-W-1843	
				A12-3235-R-1500	A8-3235-E-1721	
		Without diff. lock	3200-M-1547 except 1.85"-36 splines	A-3235-W-1843		
			RS16140, RS17140, 3200-M-1547 (1.85"-36 spline)	A-3235-Q-1941		
3200-R-1500	A15-3235-E-1721 <sup>6</sup>					
1676, 1785, 1865, 1885	A8-3235-W-1843					
Ratios 4.30, 4.33, 4.56, 4.63, 4.88, 5.13, 5.29, 5.57, 5.86, 6.14, 6.43, 6.83, 7.17 (44,000 lb. tandem axles only)	With diff. lock	1872, 1904	KIT 2648			
Without diff. lock	3200-A-1873	KIT 2647				
123, 129, 130, 204, 205, 206	Case assy. - main diff.	Ratios 2.64, 2.79, 2.93	Without diff. lock	With ABS tubes	Use 1 as req.	A2-3235-N-2172 <sup>9</sup>
						A3-3235-N-2172 <sup>6</sup>
		Ratios 3.07 and 3.21				A2-3235-M-2171 <sup>5</sup>
						A3-3235-M-2171 <sup>6</sup>
		Ratios 3.42, 3.58, 3.73, 3.90, 3.91, 4.10, 4.11 (44,000 lb tandem axles only)				A1-3235-Y-2261 <sup>6</sup>
						A3-3235-L-2170 <sup>6</sup>
Ratios 3.42, 3.58, 3.73, 3.90, 3.91, 4.10, 4.11 (except 44,000 lb) Note: 4.33 ratio for coach quality gearing also uses this std. diff. case	A2-3235-L-2170 <sup>9</sup>					

5 2.00"-39 spline

9 2.00"-39 spline. No longer available.

10 Sold as a cup and cone set only.

6 2.10"-41 spline

16 No longer available.

# CARRIERS FOR SINGLE AXLES AND REARS OF TANDEM AXLES

ITEM	DESCRIPTION	REMARKS	CARRIER	QTY	PART NUMBER	
123, 129, 130, 204, 205, 206 (Cont)	Case assy. - main diff.	Ratios 4.30, 4.33, 4.56, 4.63, 4.88, 5.13, 5.29, 5.57, 5.86, 6.14, 6.43, 6.83, 7.17 (44,000 lb. tandem axles only)	Without diff. lock	With ABS tubes	Use 1 as req.	A1-3235-K-2169 <sup>6</sup>
		Ratios 4.30, 4.33, 4.56, 4.63, 4.88, 5.13, 5.29, 5.57, 5.86, 6.14, 6.43, 6.83, 7.17 (Except 44,000 lb. tandem axles)				A2-3235-J-2168 <sup>5</sup>
						A3-3235-J-2168 <sup>6</sup>
123 thru 130	Case & nest assy main diff.	Ratios 2.64, 2.79, 2.93	With diff. lock	1558 and 1879	Use 1 as req.	A3-3235-V-1920 <sup>6</sup>
		Ratios 3.07, 3.08, 3.21 and 3.36				A3-3235-S-1839 <sup>6</sup>
		Ratios 3.42, 3.55, 3.58, 3.70, 3.73, 3.90, 3.91, 4.10, 4.11 (Except 44,000 lb tandem axles) Note: 4.33 ratio for coach quality gearing also uses this std. diff. case.				A3-3235-U-1841 <sup>6</sup>
		Ratios 4.30, 4.33, 4.56, 4.63, 4.88, 5.13, 5.29, 5.57, 5.86, 6.14, 6.43, 6.83, 7.17 (Except 44,000 lb. tandem axles)	Without diff. lock	1676, 1885	A3-3235-W-1843 <sup>6</sup>	
		Ratios 2.64, 2.79, 2.93			A10-3235-V-1920 <sup>5</sup>	
		Ratios 3.07, 3.08, 3.21, 3.36			A9-3235-V-1920 <sup>6</sup>	
		Ratios 3.42, 3.55, 3.58, 3.70, 3.73, 3.90, 3.91, 4.10, 4.11 (Except 44,000 lb tandem axles) Note: 4.33 ratio for coach quality gearing also uses this std. diff. case.			A10-3235-S-1839 <sup>5</sup>	
		Ratios 4.30, 4.33, 4.56, 4.63, 4.88, 5.13, 5.29, 5.57, 5.86, 6.14, 6.43, 6.83, 7.17 (Except 44,000 lb. tandem axles)			A9-3235-S-1839 <sup>6</sup>	
		Ratios 2.64, 2.79, 2.93			A10-3235-U-1841 <sup>5</sup>	
		Ratios 3.07, 3.08, 3.21, 3.36			A9-3235-U-1841 <sup>6</sup>	
		Ratios 3.42, 3.55, 3.58, 3.70, 3.73, 3.90, 3.91, 4.10, 4.11 (Except 44,000 lb tandem axles) Note: 4.33 ratio for coach quality gearing also uses this std. diff. case.			A9-3235-W-1843 <sup>6</sup>	
		Ratios 4.30, 4.33, 4.56, 4.63, 4.88, 5.13, 5.29, 5.57, 5.86, 6.14, 6.43, 6.83, 7.17 (Except 44,000 lb. tandem axles)			A10-3235-W-1843 <sup>5</sup>	
		Ratios 2.64, 2.79, 2.93			A11-3235-D-2188 <sup>6</sup>	
		Ratios 3.42, 3.58, 3.73, 3.90, 3.91, 4.10, 4.11 (44,000 lb. tandem axles only)	With diff. lock	1872 and 1904	A11-3235-T-2152 <sup>6</sup>	
		Ratios 4.30, 4.33, 4.56, 4.63, 4.88, 5.13, 5.29, 5.57, 5.86, 6.14, 6.43, 6.83, 7.17 (44,000 lb. tandem axles only)			A10-3235-D-2188 <sup>6</sup>	
		Ratios 3.42, 3.58, 3.73, 3.90, 3.91, 4.10, 4.11 (44,000 lb. tandem axles only)	Without diff. lock	3200-A-1873	A10-3235-T-2152 <sup>6</sup>	
		Ratios 4.30, 4.33, 4.56, 4.63, 4.88, 5.13, 5.29, 5.57, 5.86, 6.14, 6.43, 6.83, 7.17 (44,000 lb. tandem axles only)			A1-3235-S-1839 <sup>6</sup>	
Ratios 3.07, 3.08, 3.21, 3.36	Without diff. lock	3200-L-1676, 3200-A-1873				
Ratios 4.30, 4.33, 4.56, 4.63, 4.88, 5.13, 5.29, 5.57, 5.86, 6.14, 6.43, 6.83, 7.17 (44,000 lb. tandem axles only)						
Ratios 3.07, 3.08, 3.21, 3.36	Without diff. lock	3200-M-1547 except 1.85"-36 spline				

5 2.00"-39 spline

6 2.10"-41 spline

# CARRIERS FOR SINGLE AXLES AND REARS OF TANDEM AXLES

ITEM	DESCRIPTION	REMARKS	CARRIER	QTY	PART NUMBER			
123 thru 130 (Cont)	Case & nest assy main diff.	Ratios 3.42, 3.55, 3.58, 3.70, 3.73, 3.90, 3.91, 4.10, 4.11 (Except 44,000 lb tandem axles) Note: 4.33 ratio for coach quality gearing also uses this std. diff. case.	Without diff. lock	3200-M-1547 except 1.85"-36 spline	Use 1 as req.	A1-3235-U-1841 <sup>6</sup>		
		Ratios 4.30, 4.33, 4.56, 4.63, 4.88, 5.13, 5.29, 5.57, 5.86, 6.14, 6.43, 6.83, 7.17 (Except 44,000 lb. tandem axles)				A1-3235-W-1843 <sup>6</sup>		
		Ratios 2.64, 2.79, 2.93		3200-M-1885		A18-3235-V-1920 <sup>6</sup>		
		Ratios 3.42, 3.55, 3.58, 3.70, 3.73, 3.90, 3.91, 4.10, 4.11 (Except 44,000 lb tandem axles) Note: 4.33 ratio for coach quality gearing also uses this std. diff. case.		3200-R-1500		A12-3235-C-1719 <sup>7</sup>		
		Ratios 4.30, 4.33, 4.56, 4.63, 4.88, 5.13, 5.29, 5.57, 5.86, 6.14, 6.43, 6.83, 7.17 (Except 44,000 lb. tandem axles)				A14-3235-E-1721 <sup>7</sup>		
		Ratios 3.07, 3.08, 3.21, 3.36	With diff. lock	A12-3200-R-1500		A3-3235-Y-1741 <sup>16</sup>		
		Ratios 3.42, 3.55, 3.58, 3.70, 3.73, 3.90, 3.91, 4.10, 4.11 (Except 44,000 lb tandem axles) Note: 4.33 ratio for coach quality gearing also uses this std. diff. case.				A4-3235-C-1719 <sup>6</sup>		
		Ratios 4.30, 4.33, 4.56, 4.63, 4.88, 5.13, 5.29, 5.57, 5.86, 6.14, 6.43, 6.83, 7.17 (Except 44,000 lb. tandem axles)				A6-3235-E-1721 <sup>6</sup>		
				Ratios 3.42, 3.55, 3.58, 3.70, 3.73, 3.90, 3.91, 4.10, 4.11 (Except 44,000 lb tandem axles) Note: 4.33 ratio for coach quality gearing also uses this std. diff. case.	Without diff. lock	RS16140, RS17140, 3200-M-1547 (1.85"-36 spline)		A1-3235-N-1938
				Ratios 4.30, 4.33, 4.56, 4.63, 4.88, 5.13, 5.29, 5.57, 5.86, 6.14, 6.43, 6.83, 7.17 (Except 44,000 lb. tandem axles)				A1-3235-Q-1941
123, 129, 130, 131	Case & nest assy. main diff.	Ratios 4.30, 4.33, 4.56, 4.63, 4.88, 5.13, 5.29, 5.57, 5.86, 6.14, 6.43, 6.83, 7.17 (except 44,000 lb. tandem axles)	NoSPIN diff.	1676, 1785, 1865 and 1885	Use 1 as req.	A12-3235-W-1843 <sup>5</sup>		
		Ratios 3.42, 3.58, 3.73, 3.90, 3.91, 4.10, 4.11 (except 44,000 lb)					A11-3235-W-1843 <sup>6</sup>	
		Note: 4.33 ratio for coach quality gearing also uses this std. diff. case		1676, 1785, 1865, 1885		A12-3235-U-1841 <sup>9</sup>		

5 2.00"-39 spline  
 9 2.00"-39 spline. No longer available.  
 16 No longer available

6 2.10"-41 spline  
 7 2.10"-41 spline. No longer available.



# CARRIERS FOR SINGLE AXLES AND REARS OF TANDEM AXLES

ITEM	DESCRIPTION	REMARKS	CARRIER	QTY	PART NUMBER	
123, 129, 130, 131 (Cont)	Case & nest assy. main diff.	Ratios 3.42, 3.58, 3.73, 3.90, 3.91, 4.10, 4.11 (Except 44,000 lb) Note: 4.33 ratio for coach quality gearing also uses this std. diff. case	NoSPIN diff.	1676, 1785, 1865, 1885	Use 1 as req.	A11-3235-U-1841 <sup>6</sup>
				3200-A-1873		A4-3235-D-2188 <sup>6</sup>
				3200-L-1676		A12-3235-V-1920 <sup>5</sup>
						A11-3235-V-1920 <sup>6</sup>
						A12-3235-S-1839 <sup>5</sup>
123 thru 130, 204, 205, 206	Case & nest assy - main diff.	Ratios 2.64, 2.79, 2.93	Without diff. lock	With ABS tubes	Use 1 as req.	A6-3235-N-2172 <sup>5</sup>
						A7-3235-N-2172 <sup>6</sup>
						A4-3235-M-2171 <sup>5</sup>
						A5-3235-M-2171 <sup>6</sup>
						A2-3235-Y-2261 <sup>6</sup>
						A4-3235-L-2170 <sup>5</sup>
						A5-3235-L-2170 <sup>6</sup>
						A2-3235-K-2169 <sup>6</sup>
						A4-3235-J-2168 <sup>5</sup>
						A5-3235-J-2168 <sup>6</sup>
124	Thrust washer - side gear	Not used on NoSPIN	All after 11/93 except 1.85"-36 spline	2	1229-V-4624	
			All prior to 11/93 except 1.85"-36 spline		1229-X-4522	
			RS16140, RS17140, 3200-M-1547 (1.85"-36 spline)		1229-Z-3172	
125	Side gear - differential	Included in KIT 2308	RS16140, RS17140, 3200-M-1547	2	2234-T-1086 <sup>4</sup>	
		Included in KIT 2389	RS16140, RS17140, RS17145 after 11/93		2234-V-1270 <sup>5</sup>	
			RS16140, RS17140, RS17145 prior to 11/93		KIT 2758 <sup>5</sup>	
		Included in KIT 2310	RS21145 and RR20145 after 11/93		2234-U-1269 <sup>6</sup>	
			RS21145 and RR20145 prior to 11/93		KIT 2759 <sup>6</sup>	
		Included in KIT 2696	RT44145 tandems after 11/93		2234-X-1272 <sup>6</sup>	
			RT44145 tandems from 1/93 to 11/93		KIT 2760 <sup>6</sup>	
	RT44145 tandems prior to 1/93	KIT 2696 <sup>6</sup>				

4 1.85"-36 spline  
6 2.10"-41 spline

5 2.00"-39 spline

# CARRIERS FOR SINGLE AXLES AND REARS OF TANDEM AXLES

ITEM	DESCRIPTION	REMARKS	CARRIER	QTY	PART NUMBER	
126	Thrust washer - diff. pinion		All except 1.85"-36 spline	4	1229-R-1032	
			RS16140, RS17140, 3200-M-1547 (1.85"-36 spline)		1229-L-1026	
127	Gear - differential pinion		All except 1.85"-36 spline and RT44145 tandems produced after 1/93	4	2233-J-1024	
			Included in KIT 2308		RS16140, RS17140, 3200-M-1547 (1.85"-36 spline)	2233-M-1027
			Included in KIT 2696		RT44145 tandems produced after 1/93	2233-X-1116
128	Spider - differential (cross)		All except 1.85"-36 spline and RT44145 tandems produced after 1/93	1	3278-S-305	
			Included in KIT 2308		RS16140, RS17140, 3200-M-1547 (1.85"-36 spline)	3278-D-82
			Included in KIT 2696		RT44145 tandems produced after 1/93	3278-Y-1117F
129	Washer - main diff. case halves		All	16	1229-D-4632	
130	Capscrew - main diff. case halves		All	16	41-X-1327	
130A	Thread locking liquid		All	as req.	2297-C-7049	
131	NoSPIN diff. nest assembly	Serviced as assy. only. Replaces Items 124-128	3200-M-1547 (1.85"-36 spline)	1	A-3230-V-1036	
			RS16140, RS17140, RR17145, RR19145 (except 3200-M-1547 1.85"-36 spline)		A-3230-U-1035 <sup>5</sup>	
			RS17144, RS19144, RS21145, RR17144, RR19144, RR20145, RR22145		A-3230-T-1034 <sup>6</sup>	
131A	Cover - special carrier - w/o diff. lock	Without diff. lock	3200-R-1500	1	3266-M-897	
131B	Washer - cover - w/o diff. lock			4	MWA-508	
131C	Capscrew - cover - w/o diff. lock			1	41-X-1080	

**Note: The following parts are used only on rear carriers with main differential lock.**

132	Lock plate - adjusting ring R.H.		3200-R-1500	1	1220-K-89
133	Washer - lock plate		3200-R-1500	2	MWA-508
134	Capscrew - lock plate		3200-R-1500	2	MS-208020-1
135	Clutch collar - main diff. lock		1558, 1872, 1879, 1904	1	3107-D-1018
			3200-R-1500		3107-R-1006 <sup>16</sup>
136	Shift fork	Old 1 pc. design New 1 pc. design Original 3 pc. design	1558, 1872	1	3296-W-1167 <sup>10</sup>
			1879, 1904		3296-Z-1170
			3200-R-1500		3296-F-188
137	Pins - shift fork	Original design	All	2	43-X-1007
138	Spring - main diff. lock		1500, 1558, 1872	1	2258-L-714
			1879, 1904		2258-N-1262
139	Shift shaft - main diff. lock		1558, 1872	1	2244-L-1026
			1879, 1904		KIT 2824
			3200-R-1500		2244-Z-52
140	Pin - spring retaining	Original design	All	1	43-X-1006
141	Tube - air cylinder		All bolt-on designs	1	3196-F-32
142	Piston - air cylinder		Bolt-on shifter	1	2230-N-170
			Screw-in shifter		2230-T-1190
143	O-Ring - piston		Bolt-on shifter	1	5-X-1153
			Screw-in shifter		5-X-1198
144	Gasket - air cylinder cover			1	2208-H-944
145	Capscrew - manual engaging		1558, 1872	1	41-X-1330
			1879, 1904		41-X-1368
			3200-R-1500		41-X-1333
145A	O-ring - manual engaging capscrew			1	5-X-521
146	Cover - air cylinder		All bolt-on designs	1	3266-F-1020
146A	Shift cylinder assembly		Screw-in design	1	3261-A-1067
146B	Plug - screw-in DCDL cylinder hole	Non-DCDL applications only			1250-U-1217

5 2.00"-39 spline

10 Replaced old three piece design (3296-N-1080)

6 2.10"-41 spline

16 No longer available.

## CARRIERS FOR SINGLE AXLES AND REARS OF TANDEM AXLES

ITEM	DESCRIPTION	REMARKS	CARRIER	QTY	PART NUMBER
147	Capscrew - air cylinder cover		1558, 1872	4	41-X-1359
			3200-R-1500		41-X-1364
148	Washer - air cylinder cover		All bolt-on designs	4	MWA-506
149	Gasket - plug			1	2208-L-1000
150	Plug - air cylinder cover			1	MS-210016-1
151	Sensor/switch - main diff. lock	Included in KIT 4455		1	3237-W-1167
151A	Clip - sensor/switch			1	2257-M-1235
151B	Plug - DCDL switchport	Non-DCDL applications only		1	41-X-1022
152	Nut - sensor/switch		1500, 1558, 1872	1	1227-P-1056

**Note: The following parts are used only on rear carriers with internally mounted anti-lock brake system sensors.**

200	Wave washer			2	2258-U-1243
201	Snap ring			2	1229-U-4519
202	Snap ring			2	1229-B-4422
203	Sensor assembly			2	SA1-3280-U-8861
204	Sensor - drive tube	39 spline	Use KIT 2511	2	3216-S-4361
		41 spline	Use KIT 2512		3216-Q-4359
205	Washer - tube spacing			2	42-X-1248
206	Snap ring - tube retaining			2	1229-H-4428

# OUTPUT (THRU) SHAFT ASSEMBLY PARTS



ITEM	DESCRIPTION	REMARKS	AXLE MODEL	QTY	PART NUMBER
153	Output (thru) shaft, bearing cage and seal assembly	(Includes Items 154, 156, 159, 160, 161, 162, 163, 164, 165)	All	1	A1-3226-T-1112S
154	Shaft - output (thru)		All others	1	3297-E-1019
			Original design 140 tandem	1	3297-N-1158
155	Silastic gasket	3 oz. tube	All	1	2297-A-7021
156	Bearing cage and inner cup assembly - output	Must change yoke to 2"-39 spline	All others	1	A-3226-T-1112
			Original design 140 tandem	1	A1-3226-T-1112S
156A	Deflector (no longer used)			1	KIT 2583 <sup>1</sup>
157	Washer - output bearing cage		All	4	1229-K-1597
158	Capscrew - output bearing cage		All	4	15-X-387
159	Cup - inner and outer output bearing		All others	2	JLM-104910
			Original design 140 tandem	2	LM-603011
160	Cone - inner and outer output bearing		All others	2	LM-104949
			Original design 140 tandem	2	LM-603049
161	Snap ring spacer - output bearing (variable thickness) (Spacer kits are available to service these assemblies) KIT 530 is used for the original design 140 tandem. KIT 576 is used for all other models in this catalog	3.94mm/.155 inch	All others	1	1229-P-2590
			Original design 140 tandem	1	1229-A-2237
			All others	1	1229-Q-2591
			Original design 140 tandem	1	1229-B-2238
			All others	1	1229-R-2592
			Original design 140 tandem	1	1229-C-2239
			All others	1	1229-S-2593
			Original design 140 tandem	1	1229-D-2240
			All others	1	1229-T-2594
			Original design 140 tandem	1	1229-E-2241
			All others	1	1229-U-2595
			Original design 140 tandem	1	1229-F-2242
			All others	1	1229-V-2596
			Original design 140 tandem	1	1229-G-2243
All others	1	1229-W-2597			
Original design 140 tandem	1	1229-H-2244			
All others	1	1229-X-2598			
Original design 140 tandem	1	1229-J-2246			
All others	1	1229-Y-2599			
Original design 140 tandem	1	1229-K-2247			
162	Snap ring spacer - output bearing/yoke		All others	1	1229-W-4131
			Original design 140 tandem	1	1829-A-859
163	Oil seal - output bearing cage		Original design 140 tandem	1	A-1205-G-2425
			All others	1	A1-1205-Y-2729
164	Washer - output yoke and shaft	Included in KIT 2636	Original design 140 tandem	1	1229-A-2653
		Included in KIT 2637	All others	1	1229-T-1736
165	Nut - output yoke and shaft	Included in KIT 2636	Original design 140 tandem	1	40-X-1236 <sup>2</sup>
		Included in KIT 2637	All others	1	40-X-1237 <sup>3</sup>

1 Use A1-1205-Y-2729 seal & sleeve. Do not use deflector.  
3 Order KIT 2637 to purchase nut and washer.

2 Order KIT 2636 to purchase nut and washer.

# HOUSING ASSEMBLY PARTS



ITEM	DESCRIPTION	REMARKS	AXLE MODEL	QTY	PART NUMBER
167	Breather assembly		All	1	A-1199-W-4053
168	Stud - housing to carrier.	For aluminum or iron carriers	All forward carriers	2	4-X-1921
169	Plug - heat indicator		All	1	P-28-S
170	Plug - magnetic oil drain and fill	Female socket	All	1	1250-E-473
		Male socket		1	1250-L-1286
171	Plug - non-magnetic oil fill		All	1	P-212
172	Washer - carrier to housing		All	12	1229-W-1557
173	Silastic gasket - housing to carrier		All	1	2297-A-7021
174	Capscrew - carrier to housing	Included in KIT 2668	All forward carriers	3	10-X-1597
				7	10-X-1594
			All other single and rear carriers	8	10-X-1594
			RR22145, RR21145	4	S-21020A-2
				9	10-X-1594
175	Nut - carrier to housing stud		All forward carriers	2	N-110-1
176	Capscrew - brake line bracket		All	2	S-258-2
177	Gasket - brake line bracket		All others	2	2208-P-536
			RS16140, RS17140, RS19145, RS21145	4	2208-P-536
178	Washer - brake line bracket		All others	2	1229-E-1669
			RS16140, RS17140, RS19145, RS21145	4	1229-E-1669
179	Oil seal - wheel end		"L" wheel end	2	A-1205-W-1349
			"R" wheel end	2	A-1205-Q-2487
180	Cone - wheel bearing (inner)		"L" wheel end	2	47686
			"R" wheel end	2	594A
181	Cup - wheel bearing (inner)		"L" wheel end	2	47620
			"R" wheel end	2	592A
182	Cup - wheel bearing (outer)		"L" wheel end	2	39520
			"R" wheel end	2	572
183	Cone - wheel bearing (outer)		"L" wheel end	2	39590
			"R" wheel end	2	580
184	Nut - wheel bearing (inner)		"L" wheel end	2	1227-Z-1040
			"R" wheel end	2	1227-W-517
185, 185A	Lock washer and tanged lock washer	Must purchase kit which includes both items	"L" wheel end	2	KIT 2761
			"R" wheel end	2	1229-F-4634S
186	Nut - wheel bearing (outer)		"L" wheel end	2	1227-E-1045
			"R" wheel end	2	1227-R-330

# AXLE SHAFT SETS FOR 140, 141, 143, 144 & 145 SERIES AXLES

LEFT HAND	RIGHT HAND
-----------	------------

## RS-16-140 Single Axle

3202-G-9601	3202-J-9604
-------------	-------------

## RS-16-141 Single Axle

3202-X-9046	3202-Y-9047
3202-C-9597	3202-E-9599

## RS-17-140 Single Axle

3202-X-9046	3202-Y-9047
3202-B-9050	3202-C-9051
3202-Y-9281 (15)	3202-Z-9282 (15) (19)

## RS-17-144 Single Axle

3202-Q-9117	3202-R-9118
3202-F-9340	3202-G-9341
3202-S-9041	3202-T-9042
3202-S-9483	3202-T-9484
3202-H-9628	3202-K-9631
3202-S-9041	3202-U-9043 (16)
3202-Q-9117	3202-S-9119 (16)
3202-F-9340	3202-H-9342 (16)
3202-S-9483	3202-U-9485 (16)
3202-Q-9845	3202-S-9847 (16)

## RS-17-145 Single Axle

3202-X-9046	3202-Y-9047
-------------	-------------

## RS-19-144 Single Axle

3202-Q-9117	3202-R-9118
3202-F-9340	3202-G-9341
3202-S-9041	3202-T-9042
3202-S-9483	3202-T-9484
3202-H-9628	3202-K-9631
3202-S-9041	3202-U-9043 (16)
3202-Q-9117	3202-S-9119 (16)
3202-F-9340	3202-H-9342 (16)
3202-S-9483	3202-U-9485 (16)
3202-Q-9845	3202-S-9847 (16)

## RS-19-145 Single Axle

3202-X-9046	3202-Y-9047
3202-C-9597	3202-E-9599

LEFT HAND	RIGHT HAND
-----------	------------

## RS-21-145 Single Axle

3202-Q-9117	3202-R-9118
3202-F-9340	3202-G-9341
3202-S-9041	3202-T-9042
3202-S-9483	3202-T-9484
3202-H-9628	3202-K-9631
3202-S-9041	3202-U-9043 (16)
3202-Q-9117	3202-S-9119 (16)
3202-F-9340	3202-H-9342 (16)
3202-S-9483	3202-U-9485 (16)
3202-Q-9845	3202-S-9847 (16)

## RD-17-140 Forward Axle of RT-34-140 Tandem

3202-Y-9047	3202-X-9046
3202-E-9599	3202-C-9597

## RR-17-140 Rear Axle of RT-34-140 Tandem

3202-X-9046	3202-Y-9047
3202-C-9597	3202-E-9599

## RD-17-144 Forward Axle of RT-34-144 Tandem

3202-R-9118	3202-Q-9117
3202-G-9341	3202-F-9340
3202-T-9042	3202-S-9041
3202-Y-9463	3202-W-9461
3202-T-9484	3202-S-9483
3202-Q-9611	3202-N-9608
3202-U-9615	3202-W-9617
3202-K-9631	3202-H-9628
3206-S-1345 (17)	3206-Q-1343 (17)
3206-U-1347 (17)	3206-T-1346 (17)
3206-Y-1351 (17)	3206-W-1349 (17)
3206-A-1353 (17)	3206-Z-1352 (17)
3202-U-9043 (16)	3202-S-9041
3202-S-9119 (16)	3202-Q-9117
3202-H-9342 (16)	3202-F-9340
3202-U-9485 (16)	3202-S-9483
3202-R-9638 (16)	3202-W-9461

(15) These shafts are for original design 1.85"-36 spline.

(17) Not for use with main diff. lock or No-SPIN units.

(16) This shaft has longer splines that engage the differential lock.

(19) No longer available.

# AXLE SHAFT SETS FOR 140, 141, 143, 144 & 145 SERIES AXLES

LEFT HAND	RIGHT HAND
-----------	------------

**RP-17-144** Fwd Axle of RT-34-144 Tandem (w/Pump)

3202-R-9118	3202-Q-9117
3202-G-9341	3202-F-9340
3202-T-9042	3202-S-9041
3202-T-9484	3202-S-9483
3202-Q-9611	3202-N-9608
3202-U-9615	3202-W-9617
3202-K-9631	3202-H-9628
3206-S-1345 (17)	3206-Q-1343 (17)
3206-U-1347 (17)	3206-T-1346 (17)
3206-Y-1351 (17)	3206-W-1349 (17)
3206-A-1353 (17)	3206-Z-1352 (17)
3202-U-9043 (16)	3202-S-9041
3202-S-9119 (16)	3202-Q-9117
3202-H-9342 (16)	3202-F-9340
3202-U-9485 (16)	3202-S-9483
3202-S-9613 (16)	3202-N-9608

**RR-17-144** Rear Axle of RT-34-144 Tandem

3202-Q-9117	3202-R-9118
3202-F-9340	3202-G-9341
3202-S-9041	3202-T-9042
3202-W-9461	3202-Y-9463
3202-S-9483	3202-T-9484
3202-N-9608	3202-Q-9611
3202-W-9617	3202-U-9615
3202-H-9628	3202-K-9631
3206-Q-1343 (17)	3206-S-1345 (17)
3206-T-1346 (17)	3206-U-1347 (17)
3206-W-1349 (17)	3206-Y-1351 (17)
3206-Z-1352 (17)	3206-A-1353 (17)
3202-S-9041	3202-U-9043 (16)
3202-Q-9117	3202-S-9119 (16)
3202-F-9340	3202-H-9342 (16)
3202-S-9483	3202-U-9485 (16)
3202-W-9461	3202-R-9638 (16)

**RD-17-145** Forward Axle of RT-34-145 Tandem

3202-Y-9047	3202-X-9046
3202-E-9599	3202-C-9597

**RR-17-145** Rear Axle of RT-34-145 Tandem

3202-X-9046	3202-Y-9047
3202-C-9597	3202-E-9599

(16) This shaft has longer splines that engage the differential lock.

(17) Not for use with main diff. lock or No-SPIN units.

LEFT HAND	RIGHT HAND
-----------	------------

**RD-19-144** Forward Axle of RT-38-144 Tandem

3202-R-9118	3202-Q-9117
3202-G-9341	3202-F-9340
3202-T-9042	3202-S-9041
3202-Y-9463	3202-W-9461
3202-T-9484	3202-S-9483
3202-Q-9611	3202-N-9608
3202-U-9615	3202-W-9617
3202-K-9631	3202-H-9628
3206-S-1345 (17)	3206-Q-1343 (17)
3206-U-1347 (17)	3206-T-1346 (17)
3206-Y-1351 (17)	3206-W-1349 (17)
3206-A-1353 (17)	3206-Z-1352 (17)
3202-U-9043 (16)	3202-S-9041
3202-S-9119 (16)	3202-Q-9117
3202-H-9342 (16)	3202-F-9340
3202-U-9485 (16)	3202-S-9483
3202-R-9638 (16)	3202-W-9461

**RP-19-144** Fwd Axle of RT-38-144 Tandem (w/Pump)

3202-R-9118	3202-Q-9117
3202-G-9341	3202-F-9340
3202-T-9042	3202-S-9041
3202-T-9484	3202-S-9483
3202-Q-9611	3202-N-9608
3202-U-9615	3202-W-9617
3202-K-9631	3202-H-9628
3206-S-1345 (17)	3206-Q-1343 (17)
3206-U-1347 (17)	3206-T-1346 (17)
3206-Y-1351 (17)	3206-W-1349 (17)
3206-A-1353 (17)	3206-Z-1352 (17)
3202-U-9043 (16)	3202-S-9041
3202-S-9119 (16)	3202-Q-9117
3202-H-9342 (16)	3202-F-9340
3202-U-9485 (16)	3202-S-9483
3202-S-9613 (16)	3202-N-9608

# AXLE SHAFT SETS FOR 140, 141, 143, 144 & 145 SERIES AXLES

LEFT HAND	RIGHT HAND
-----------	------------

**RR-19-144** Rear Axle of RT-38-144 Tandem

3202-Q-9117	3202-R-9118
3202-F-9340	3202-G-9341
3202-S-9041	3202-T-9042
3202-W-9461	3202-Y-9463
3202-S-9483	3202-T-9484
3202-N-9608	3202-Q-9611
3202-W-9617	3202-U-9615
3202-H-9628	3202-K-9631
3206-Q-1343 (17)	3206-S-1345 (17)
3206-T-1346 (17)	3206-U-1347 (17)
3206-W-1349 (17)	3206-Y-1351 (17)
3206-Z-1352 (17)	3206-A-1353 (17)
3202-S-9041	3202-U-9043 (16)
3202-Q-9117	3202-S-9119 (16)
3202-F-9340	3202-H-9342 (16)
3202-S-9483	3202-U-9485 (16)
3202-W-9461	3202-R-9638 (16)

**MD-20-143** Forward Axle of MT-40-143 Tandem

3202-S-9483	3202-U-9485
3206-T-1346	3206-U-1347
3206-W-1349	3206-Y-1351
3206-C-1563	3206-X-1740
3206-F-1748	3206-G-1749
3206-C-1823	3206-D-1824
3206-M-1885	3206-P-1888

**MP-20-143** Forward Axle of MT-40-143 Tandem (w/Pump)

3206-W-1349	3206-Y-1351
-------------	-------------

**MR-20-143** Rear Axle of MT-40-143 Tandem

3206-T-1346	3206-U-1347
3206-W-1349	3206-Y-1351
3206-C-1563	3206-X-1740
3206-F-1748	3206-G-1749
3206-C-1823	3206-D-1824
3206-M-1885	3206-P-1888

**RD-20-140** Forward Axle of RT-40-140 Tandem

3202-R-9118	3202-Q-9117
3202-G-9341	3202-F-9340
3202-T-9042	3202-S-9041
3202-T-9484	3202-S-9483

LEFT HAND	RIGHT HAND
-----------	------------

**RR-20-140** Rear Axle of RT-40-140 Tandem

3202-Q-9117	3202-R-9118
3202-F-9340	3202-G-9341
3202-S-9041	3202-T-9042
3202-S-9483	3202-T-9484

**RD-20-145** Forward Axle of RT-40-145 Tandem

3202-R-9118	3202-Q-9117
3202-G-9341	3202-F-9340
3202-T-9042	3202-S-9041
3202-Y-9463	3202-W-9461
3202-T-9484	3202-S-9483
3202-Q-9611	3202-N-9608
3202-U-9615	3202-W-9617
3202-K-9631	3202-H-9628
3206-S-1345 (17)	3206-Q-1343 (17)
3206-U-1347 (17)	3206-T-1346 (17)
3206-Y-1351 (17)	3206-W-1349 (17)
3206-A-1353 (17)	3206-Z-1352 (17)
3202-U-9043 (16)	3202-S-9041
3202-S-9119 (16)	3202-Q-9117
3202-H-9342 (16)	3202-F-9340
3202-U-9485 (16)	3202-S-9483
3202-R-9638 (16)	3202-W-9461

**RP-20-145** Fwd Axle of RT-40-145 Tandem (w/Pump)

3202-R-9118	3202-Q-9117
3202-G-9341	3202-F-9340
3202-T-9042	3202-S-9041
3202-T-9484	3202-S-9483
3202-Q-9611	3202-N-9608
3202-U-9615	3202-W-9617
3202-K-9631	3202-H-9628
3206-S-1345 (17)	3206-Q-1343 (17)
3206-U-1347 (17)	3206-T-1346 (17)
3206-Y-1351 (17)	3206-W-1349 (17)
3206-A-1353 (17)	3206-Z-1352 (17)
3202-U-9043 (16)	3202-S-9041
3202-S-9119 (16)	3202-Q-9117
3202-H-9342 (16)	3202-F-9340
3202-U-9485 (16)	3202-S-9483
3202-S-9613 (16)	3202-N-9608

(16) This shaft has longer splines that engage the differential lock.

(17) Not for use w/ith main diff. lock or No-SPIN units.



## AXLE SHAFT SETS FOR 140, 141, 143, 144 & 145 SERIES AXLES

LEFT HAND	RIGHT HAND
-----------	------------

**RR-20-145** Rear Axle of RT-40-145 Tandem

3202-Q-9117	3202-R-9118
3202-F-9340	3202-G-9341
3202-S-9041	3202-T-9042
3202-W-9461	3202-Y-9463
3202-S-9483	3202-T-9484
3202-N-9608	3202-Q-9611
3202-W-9617	3202-U-9615
3202-H-9628	3202-K-9631
3206-Q-1343 <b>(17)</b>	3206-S-1345 <b>(17)</b>
3206-T-1346 <b>(17)</b>	3206-U-1347 <b>(17)</b>
3206-W-1349 <b>(17)</b>	3206-Y-1351 <b>(17)</b>
3206-Z-1352 <b>(17)</b>	3206-A-1353 <b>(17)</b>
3202-S-9041	3202-U-9043 <b>(16)</b>
3202-Q-9117	3202-S-9119 <b>(16)</b>
3202-F-9340	3202-H-9342 <b>(16)</b>
3202-S-9483	3202-U-9485 <b>(16)</b>
3202-W-9461	3202-R-9638 <b>(16)</b>

**RD-20-146** Forward Axle of RT-40-146 Tandem

3202-R-9118	3202-Q-9117
-------------	-------------

**RP-20-146** Forward Axle of RT-40-146 Tandem (w/Pump)

3202-R-9118	3202-Q-9117
-------------	-------------

**RR-20-146** Rear Axle of RT-40-146 Tandem

3202-Q-9117	3202-R-9118
-------------	-------------

LEFT HAND	RIGHT HAND
-----------	------------

**RD-22-145** Forward Axle of RT-44-145 Tandem

3202-R-9118	3202-Q-9117
3202-G-9341	3202-F-9340
3202-T-9042	3202-S-9041
3202-T-9484	3202-S-9483
3202-U-9043 <b>(16)</b>	3202-S-9041
3202-H-9342 <b>(16)</b>	3202-F-9340
3202-U-9485 <b>(16)</b>	3202-S-9483

**RP-22-145** Forward Axle of RT-44-145 Tandem (w/Pump)

3202-R-9118	3202-Q-9117
3202-G-9341	3202-F-9340
3202-T-9042	3202-S-9041
3202-T-9484	3202-S-9483
3202-U-9043 <b>(16)</b>	3202-S-9041
3202-S-9119 <b>(16)</b>	3202-Q-9117
3202-U-9485 <b>(16)</b>	3202-S-9483

**RR-22-145** Rear Axle of RT-44-145 Tandem

3202-S-9041	3202-T-9042
3202-Q-9117	3202-R-9118
3202-F-9340	3202-G-9341
3202-S-9483	3202-T-9484
3202-S-9041	3202-U-9043 <b>(16)</b>
3202-F-9340	3202-H-9342 <b>(16)</b>
3202-S-9483	3202-U-9485 <b>(16)</b>
3202-Q-9117	3202-S-9119 <b>(16)</b>

**(16)** This shaft has longer splines that engage the differential lock.

**(17)** Not for use with main diff. lock or No-SPIN units.

# AXLE SHAFTS

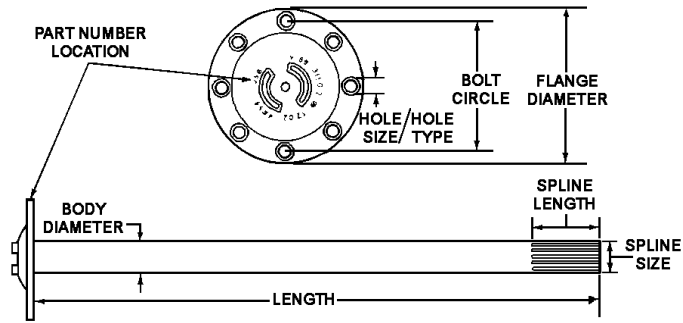

Part Number	Body Dia.	Length	Spline Size	Spline Len.	Flange Dia.	No. of Holes	Hole Size	Bolt Circle	Hole Type
3202-G-9601	1.62"	37.51"	2.00"-39	2.88"	6.25"	12	.50"	5.25"	Taper
3202-J-9604	1.62"	43.54"	2.00"-39	2.88"	6.25"	12	.50"	5.25"	Taper
3202-B-9050	1.75"	37.87"	1.85"-36	2.60"	6.25"	12	.50"	5.25"	Taper
3202-Y-9281	1.75"	38.21"	1.85"-36	2.60"	6.25"	12	.50"	5.25"	Taper
3202-C-9051	1.75"	43.89"	1.85"-36	2.60"	6.25"	12	.50"	5.25"	Taper
3206-F-1748	1.88"	35.75"	2.10"-41	2.88"	8.38"	8	.73"	7.00"	Taper
3206-M-1885	1.88"	35.86"	2.10"-41	2.88"	7.93"	12	.59"	6.75"	Taper
3206-Z-1352 <sup>16</sup>	1.88"	37.06"	2.10"-41	2.88"	8.38"	8	.73"	7.00"	Taper
3206-W-1349	1.88"	37.06"	2.10"-41	2.88"	8.38"	8	.78"	7.00"	Straight
3202-C-9597	1.88"	37.45"	2.00"-39	2.88"	6.63"	8	.63"	5.50"	Straight
3202-X-9046	1.88"	37.63"	2.00"-39	2.88"	6.25"	12	.50"	5.25"	Taper
3206-T-1346	1.88"	37.92"	2.10"-41	2.88"	8.38"	8	.64"	7.00"	Straight
3206-Q-1343	1.88"	37.92"	2.10"-41	2.88"	8.38"	8	.73"	7.00"	Taper
3206-G-1749	1.88"	41.70"	2.10"-41	2.88"	8.38"	8	.73"	7.00"	Taper
3206-P-1888	1.88"	41.75"	2.10"-41	2.88"	7.93"	12	.59"	6.75"	Taper
3206-A-1353	1.88"	43.01"	2.10"-41	2.88"	8.38"	8	.73"	7.00"	Taper
3206-Y-1351	1.88"	43.01"	2.10"-41	2.88"	8.38"	8	.78"	7.00"	Straight
3202-E-9599	1.88"	43.36"	2.00"-39	2.88"	6.43"	8	.63"	5.50"	Straight
3202-Y-9047	1.88"	43.54"	2.00"-39	2.88"	6.25"	12	.50"	5.25"	Taper
3206-U-1347	1.88"	43.87"	2.10"-41	2.88"	8.38"	8	.64"	7.00"	Straight
3206-S-1345	1.88"	43.87"	2.10"-41	2.88"	8.38"	8	.73"	7.00"	Taper
3202-Q-9845	2.00"	34.76"	2.10"-41	2.88"	8.38"	8	.73"	7.00"	Taper
3202-S-9847	2.00"	35.60"	2.10"-41	8.12"	8.38"	8	.73"	7.00"	Taper
3206-C-1563	2.00"	35.70"	2.10"-41	2.88"	8.38"	8	.73"	7.00"	Taper
3206-C-1823	2.00"	35.73"	2.10"-41	2.88"	8.38"	12	.59"	6.75"	Taper
3202-F-9340	2.00"	37.18"	2.10"-41	2.88"	8.38"	8	.73"	7.00"	Taper
3202-Q-9117	2.00"	37.18"	2.10"-41	2.88"	8.38"	8	.78"	7.00"	Straight
3202-S-9483	2.00"	38.04"	2.10"-41	2.88"	8.38"	8	.64"	7.00"	Straight
3202-S-9041	2.00"	38.04"	2.10"-41	2.88"	8.38"	8	.73"	7.00"	Taper
3202-H-9628	2.00"	38.14"	2.10"-41	2.88"	8.38"	8	.73"	7.00"	Taper
3202-W-9617	2.00"	40.00"	2.10"-41	2.88"	8.38"	8	.78"	7.00"	Straight
3202-W-9461	2.00"	40.73"	2.10"-41	2.88"	8.38"	8	.64"	7.00"	Straight
3202-N-9608	2.00"	40.85"	2.10"-41	2.88"	8.38"	8	.73"	7.00"	Taper
3206-X-1740	2.00"	41.49"	2.10"-41	2.88"	8.38"	8	.73"	7.00"	Taper
3206-D-1824	2.00"	41.68"	2.10"-41	2.88"	8.38"	12	.59"	6.75"	Taper
3202-K-9631	2.00"	42.43"	2.10"-41	2.88"	8.38"	8	.73"	7.00"	Taper
3202-G-9341	2.00"	43.13"	2.10"-41	2.88"	8.38"	8	.73"	7.00"	Taper
3202-R-9118	2.00"	43.13"	2.10"-41	2.88"	8.38"	8	.78"	7.00"	Straight
3202-X-9488	2.00"	43.13"	2.10"-41	8.12"	8.38"	8	.64"	7.00"	Straight
3202-H-9342	2.00"	43.13"	2.10"-41	8.12"	8.38"	8	.73"	7.00"	Taper
3202-S-9119	2.00"	43.13"	2.10"-41	8.12"	8.38"	8	.78"	7.00"	Straight
3202-U-9043	2.00"	43.80"	2.10"-41	8.12"	8.38"	8	.73"	7.00"	Taper
3202-T-9484	2.00"	43.99"	2.10"-41	2.88"	8.38"	8	.64"	7.00"	Straight
3202-T-9042	2.00"	43.99"	2.10"-41	2.88"	8.38"	8	.73"	7.00"	Taper
3202-U-9485	2.00"	44.00"	2.10"-41	8.12"	8.38"	8	.64"	7.00"	Straight
3202-U-9615	2.00"	45.94"	2.10"-41	2.88"	8.38"	8	.78"	7.00"	Straight
3202-Y-9619	2.00"	45.94"	2.10"-41	8.12"	8.38"	8	.78"	7.00"	Straight
3202-Y-9463	2.00"	46.80"	2.10"-41	2.88"	8.38"	8	.64"	7.00"	Straight
3202-Q-9611	2.00"	46.80"	2.10"-41	2.88"	8.38"	8	.73"	7.00"	Taper
3202-R-9638	2.00"	46.80"	2.10"-41	8.12"	8.38"	8	.64"	7.00"	Straight
3202-S-9613	2.00"	46.80"	2.10"-41	8.12"	8.38"	8	.73"	7.00"	Taper

<sup>16</sup> No longer available.

# ROUND BEARING TYPE YOKES



Axle Model (Location)	Center to End	Spline Length	Hub Dia.	Bearing Cap Diameter	Yoke Dimension Across Ears	Spline Size Dia. - No. Teeth	Part Number	Production Part Number
RS-16-140 RS-17-140 (Input)	4.88"	2.25"	2.50"	1.88" 1.94"	5.31" 6.09"	1.75"-34	16N-4-5621X 17NYS28-43A	A-3280-Q-7115 A-3260-H-8
RS-16-141 RS-17-141 RS-17-144 RS-19-144 RS-19-145 RS-21-145 (Input)	5.54" 6.22" 5.19" 5.16" 6.25" 5.19"	2.31"	3.00"	1.88" 1.88" 1.94" 1.94" 1.94" 1.94"	5.31" 5.31" 7.00" 6.09" 6.09" 7.55"	2.00"-39	16N-4-6281X 16N-4-6291X 176NYS32-3A2 17NYS32-100A 17N-4-6391X 18NYS32-12A3	A-3260-G-111 A-3260-H-112 A2-3260-K-115 A1-3260-P-120 A3-3260-L-116
RT-34-140 RT-40-140 MT-40-143 RT-34-144 RT-38-144 RT-34-145	5.54" 6.22" 5.19" 5.16" 6.25" 5.19"	2.31"	3.00"	1.88" 1.88" 1.94" 1.94" 1.94" 1.94"	5.31" 5.31" 7.00" 6.09" 6.09" 7.55"	2.00"-39	16N-4-6281X 16N-4-6291X 176N-4-541X 17N-4-6411X 17NYS32-99A 18NYS32-12A3	A-3260-G-111 A-3260-H-112 A-3260-K-115 A-3260-Q-121 A3-3260-L-116
RT-40-145 RT-44-145 (Fwd. Input)	4.94" 5.38" 5.06" 5.16"	2.32"	3.25"	1.88" 1.94" 1.94" 1.94"	5.31" 6.09" 7.00" 7.55"	2.38"-46	16NYS38-8A 17N-4-7181X 176NYS38-14A 18NYS38-27A	A-3260-T-1034 A-3260-U-359 A-3260-V-360
(Fwd. Output) (Original Design 140 Tandem)	6.03" 5.44" 5.97" 4.88"	2.25"	2.50"	1.88" 1.88" 1.94" 1.94"	5.31" 5.31" 6.09" 6.09"	1.75"-34	16N-4-6251 16N-4-6261 17N-4-6321 17N-4-6331	3260-U-125 3260-T-124 3260-W-127 3260-V-126
(Fwd. Output) (All Others)	5.19" 5.16" 6.25"	2.31"	3.00"	1.94" 1.94" 1.94"	7.00" 6.09" 6.09"	2.00"-39	176N-4-531 17NYS32-100 17NYS32-99	3260-K-115
(Rear Input)	5.54" 6.22" 5.19" 5.16" 6.25"	2.31"	3.00"	1.88" 1.88" 1.94" 1.94" 1.94"	5.31" 5.31" 7.00" 6.09" 6.09"	2.00"-39	16N-4-6281X 16N-4-6291X 176NYS32-3A2 17NYS32-100A 17N-4-6391X	A-3260-G-111 A-3260-H-112 A2-3260-K-115 A1-3260-P-120

# WING BEARING TYPE YOKES



Axle Model (Location)	Face to End	Spline Length	Hub Dia.	Pilot Diameter	Keyway Width	Spline Size Dia. - No. Teeth	Hole Type	Part Number	Production Part Number
RS-16-140	3.88"	2.25"	2.50"	5.31"	.63"	1.75"-34	TH	58WBYS28-182A	A-3260-L-38
RS-17-140	3.88"			5.31"	.63"		TH	58WBYS28-186A	A-3260-K-63
(Input)	3.31"			5.53"	.56"		TH	62NYS28-160A	A-3260-Z-52
	3.94"			5.53"	.56"		DR	62NYS28-201A	A-3260-Q-1135
	3.94"			5.53"	.56"		TH	62NYS28-202A	A-3260-S-1137
	3.75"			5.84"	.63"		TH	72NYS28-166A	A-3260-F-32
RS-16-141	3.81"	2.31"	3.00"	5.31"	.63"	2.00"-39	TH	58WBYS32-47A <sup>16</sup>	A-3260-S-253
RS-17-141	3.81"			5.84"	.63"		TH	72NYS32-244A	A-3260-S-123
RS-19-145	3.88"			8.13"	.63"		TH	82NYS32-74A1	A1-3260-M-117
RS-21-145	4.25"			8.25"	.63"		TH	92NYS32-25A1	A1-3260-N-118
(Input)	4.44"			8.25"	.63"		DR	92NYS32-26A	A-3260-B-132
(Fwd. Input)	3.81"	2.31"	3.00"	5.84"	.63"	2.00"-39	TH	72NYS32-244A1	A1-3260-S-123
RT-34-140	4.25"			8.25"	.63"		TH	92NYS32-25A	A-3260-N-118
	4.22"	2.32"	3.25"	8.25"	.63"	2.38"-46	TH	92NYS38-73A	A-3260-K-1129
RT-34-145									
RT-40-145									
RT-44-145									
(Fwd. Output) (Original Design 140 Tandem)	3.81"	2.31"	3.00"	5.84"	.63"	2.00"-39	TH	72NYS32-244	3260-S-123
	4.25"			8.25"	.63"		TH	92NYS32-25	3260-N-118
	4.44"			8.25"	.63"		DR	92NYS32-26	3260-B-132
(All Others)	3.63"	2.25"	2.50"	5.84"	.63"	1.75"-34	TH	72NYS28-176	3260-X-128
	4.69"			5.84"	.63"		DR	72NYS28-177	3260-Y-129
	4.25"			5.84"	.63"		TH	72NYS28-179	3260-X-154
	4.25"			8.25"	.63"		DR	92NYS28-5	3260-A-131
(Rear Input)	3.81"	2.31"	3.00"	5.31"	.63"	2.00"-39	TH	58WBYS32-47A	A-3260-S-253
	3.81"			5.84"	.63"		TH	72NYS32-244A	A-3260-S-123
	3.88"			8.13"	.63"		TH	82NYS32-74A1	A1-3260-M-117
	4.25"			8.25"	.63"		TH	92NYS32-25A1	A1-3260-N-118
	4.44"			8.25"	.63"		DR	92NYS32-26A	A-3260-B-132

<sup>16</sup> No longer available.

## EASY SERVICE (STRAP) TYPE YOKES



Axle Model (Location)	Center to End	Spline Length	Hub Dia.	Bearing Cap Diameter	Distance Between Nibbs	Spline Size Dia. - No. Teeth	Hole Type	Part Number	Production Part Number
RS-16-140 RS-17-140 (Input)	4.19"	2.25"	2.50"	1.19"	4.19"	1.75"-34	DR	141DYS28A	A-3280-J-8070
	4.47"			1.38"	4.19"		DR	148DYS28A	
	4.69"			1.38"	4.97"		DR	155DYS28-1A	A-3260-N-248
	4.66"			1.38"	4.97"		DR	155NYS28-5A	A-3260-B-2
	4.88"			1.88"	5.31"		TH	16TYS28-13A	A-3260-J-1232
	4.88"			1.94"	6.19"		TH	17TYS28-57A	A-3260-V-1296
RS-16-141 RS-17-141 RS-17-144 RS-19-144 RS-19-145 RS-21-145 (Input)	4.75"	2.31"	3.00"	1.38"	4.19"	2.00"-39	TH	148TYS32-4A	A-3260-S-1241
	4.75"			1.38"	4.97"		DR	155DYS32-6A	A-3260-F-318
	4.75"			1.38"	4.97"		TH	155TYS32-6A	A-3260-A-1353
	5.54"			1.88"	5.31"		TH	16TYS32-32A	A-3260-F-1280
	6.22"			1.88"	5.31"		TH	16TYS32-76A	A-3260-D-1668
	4.88"			1.88"	5.31"		TH	16TYS32-86A	
	5.19"			1.94"	7.09"		TH	176TYS32-3A1	A1-3260-S-1267
	6.25"			1.94"	6.19"		TH	17TYS32-99A	
	5.16"			1.94"	6.19"		TH	17N-4-7631-1X	A-3260-R-1292
	5.19"			1.94"	7.63"		TH	18TYS32-12A1	A1-3260-N-1262
	RT-34-140 RT-40-140 RT-34-144 RT-38-144 RT-34-145 RT-40-145 RT-44-145 (Fwd. Input)			4.38"	2.32"		3.25"	1.38"	4.97"
4.88"		1.88"	5.31"	TH		16N-4-6431-1X			
5.19"		1.94"	7.09"	TH		176N-4-541-1X		A-3260-S-1267	
6.25"		1.94"	6.19"	TH		17TYS32-95A1			
5.16"		1.94"	6.19"	TH		17N-4-7641-1X		A1-3260-R-1292	
5.19"		1.94"	7.63"	TH		18N-4-3381-1X		A-3260-N-1262	
4.94"		1.88"	5.31"	TH		16N-4-7341-1X		A-3260-L-1234	
5.38"		1.94"	6.19"	TH		17TYS38-76A			
5.06"		1.94"	7.09"	TH		176TYS38-27A			
5.16"		1.94"	7.64"	TH		18TYS38-27A			
(Fwd. Output) (New Design Only)	4.75"	2.31"	3.00"	1.38"	4.97"	2.00"-39	DR	155DYS32-6	3260-F-318
	5.54"			1.88"	5.31"		TH	16N-4-6271-1	3260-F-1280
	6.22"			1.88"	5.31"		TH	16TYS32-76	3260-D-1668
	6.25"			1.94"	6.19"		TH	17TYS32-99	
(Rear Input)	4.75"	2.31"	3.00"	1.38"	4.19"	2.00"-39	TH	148TYS32-4A	A-3260-S-1241
	4.75"			1.38"	4.97"		DR	155DYS32-6A	A-3260-F-318
	4.75"			1.38"	4.97"		TH	155TYS32-6A	A-3260-A-1353
	5.54"			1.88"	5.31"		TH	16TYS32-32A	A-3260-F-1280
	6.22"			1.88"	5.31"		TH	16TYS32-76A	A-3260-D-1668
	4.88"			1.88"	5.31"		TH	16TYS32-86A	
	5.19"			1.94"	7.09"		TH	176TYS32-3A1	A1-3260-S-1267
	6.25"			1.94"	6.19"		TH	17TYS32-99A	
	5.16"			1.94"	6.19"		TH	17N-4-7631-1X	A-3260-R-1292
	5.19"			1.94"	7.63"		TH	18TYS32-12A1	A1-3260-N-1262
	MT-40-143 Forward Input			5.10"	2.32"		3.25"	2.17"	6.46"
5.32"		2.36"	6.41"	TH		250TYS38-2A		A-3260-H-1828	
Forward Output	5.09"	2.31"	3.00"	2.17"	6.46"	2.00"-39		170TYS32-2	3260-G-1827
Rear Input	5.09"	2.31"	3.00"	2.17"	6.46"	2.00"-39		170TYS32-2A	A-3260-G-1827
	6.39"			2.17"	6.46"			170TYS32-1A	A-3260-J-1830

## RPL SERIES YOKES



Axle Model	Face to End	Hub Dia.	Spline Length	Yoke Dimension Across Nibbs	Spline Size Dia. - No. Teeth	Part Number
MT-40-143 (Fwd. Input)	4.90"	3.25"	2.32"	7.06"	2.38"-46	20WYS38-4A
	4.73"			8.38"		25WYS38-13A
(Fwd. Output)	5.95"	3.00"	2.31"	7.06"	2.00"-39	20WYS32-2
	5.95"			7.06"		20WYS32-2A

# COMPANION FLANGES



Axle Model (Location)	Face to End	Spline Length	Hub Dia.	Pilot Dia. M=Male F=Female	Flange Dia.	Hole Size	Bolt Circle Dia.	Spline Size Dia. - No. Teeth	Part Number	Production Part Number
RS-16-140	2.84"	2.25"	2.50"	F-3.75"	Square Flange	.51"	4.75"	1.75"-34	<b>2WCS28-73A</b>	A-3260-D-4
RS-17-140 (Input)	2.94"			F-7.75"	8.00"	.38"	7.25"		<b>5WCS28-54A</b>	A-3260-G-7
RS-16-141	3.38"	2.31"	3.00"	F-6.63"	6.88"	.38"	6.13"	2.00"-39	<b>3WCS32-73A1</b>	A1-3260-V-152
RS-17-141	3.31"			F-7.75"	8.00"	.41"	7.25"		<b>5WCS32-86A2</b>	A2-3260-F-136
RS-17-144										
RS-19-144										
RS-19-145										
RS-21-145 (Input)										
(Fwd. Input)	3.38"	2.31"	3.00"	F-6.63"	6.88"	.38"	6.13"	2.00"-39	<b>3WCS32-73A</b>	A-3260-V-152
RT-34-140	3.31"			F-7.75"	8.00"	.41"	7.25"		<b>5WCS32-86A</b>	A-3260-F-136
RT-40-140	2.62"			F-7.75"	8.00"	.44"	7.25"		<b>5WCS32-89A</b>	A-3260-E-213
RT-34-144	3.27"			F-7.75"	8.00"	.40"	7.25"		<b>5WCS32-94A</b>	A-3260-M-325
RT-38-144										
RT-34-145										
RT-40-145										
RT-44-145										
(Fwd. Output) (Original Design 140 Tandem)	2.94"	2.25"	2.50"	F-6.63"	6.88"	.38"	6.13"	1.75"-34	<b>3WCS28-93</b>	3260-J-10
(All Others)	3.31"	2.31"	3.00"	F-7.75"	8.00"	.41"	7.25"	2.00"-39	<b>5WCS32-86</b>	3260-F-136
(Rear Input)	3.38"	2.31"	3.00"	F-6.63"	6.88"	.38"	6.13"	2.00"-39	<b>3WCS32-73A1</b>	A1-3260-V-152
	3.31"			F-7.75"	8.00"	.41"	7.25"		<b>5WCS32-86A2</b>	A2-3260-F-136

## AXLE MODEL TO CARRIER TO KIT CROSS REFERENCE

AXLE MODEL	BASE CARRIER	KIT DESCRIPTION	KIT NUMBER
RS-16-140	3200-M-1547 Standard	Carrier overhaul	KIT RS-17-140
		Carrier bearings and oil seals	KIT 4345
		Pinion bearing cage shims	KIT 2313
		Pinion bearing spacers	KIT 2321
		Main differential nest w ith spider	KIT 2308
		Main differential nest w ithout spider	KIT 2309
		Ring gear to differential case bolts, nuts and w ashers	KIT 2317
	3200-L-1676 Standard	Carrier bearings and oil seals	KIT 4350
		Pinion bearing cage shims	KIT 2313
		Pinion bearing spacers	KIT 2321
		Main differential nest w ith spider	KIT 2389
		Main differential nest w ithout spider	KIT 2431
		Ring gear to differential case bolts, nuts and w ashers	KIT 2317
		RS-16-141	3200-L-1676 Standard
3200-Q-1785 Standard	Pinion bearing cage shims		KIT 2313
3200-S-1865 Standard	Pinion bearing spacers		KIT 2322
	Main differential nest w ith spider		KIT 2389
	Main differential nest w ithout spider		KIT 2431
	Ring gear to differential case bolts, nuts and w ashers		KIT 2317
	Carrier and cap upgrade to thrust screw version		KIT 2756
	RS-17-140		3200-M-1547 Standard
3200-L-1676 Standard			
3200-Q-1785 Standard			
3200-S-1865 Standard			
3200-M-1547 NoSpin diff. 3200-L-1676 NoSpin diff. 3200-Q-1785 NoSpin diff. 3200-S-1865 NoSpin diff.		See kits for same base carrier of RS-16-140 except KIT RS-17-140, KIT 2308, KIT 2309, KIT 2389 and KIT 2431 cannot be used as they apply to standard differential nest type carriers.	-
RS-17-141	3200-L-1676 Standard	See kits for same base carrier of RS-16-141	-
	3200-Q-1785 Standard		
	3200-S-1865 Standard		
RD-17-145	3200-G-1645 Standard 3200-T-1814 Standard 3200-B-1978 Standard	Carrier bearings and oil seals (Prior to 11/93)	KIT 4395
		Carrier bearings and oil seals (After 11/93)	KIT 4396
		Input brg cage shims & pinion inner brg cup shims	KIT 2429
		Pinion bearing spacers	KIT 2396
		Main differential nest w ith spider	KIT 2389
		Main differential nest w ithout spider	KIT 2431
		Ring gear to differential case bolts, nuts and w ashers	KIT 2317
		Output bearing snap ring spacers	KIT 576
		Inter-axle differential case and nest (Prior to 10/98)	KIT 2488
		Inter-axle differential case and nest (After 10/98)	KIT 2522
		Helical gears	KIT 2482
		Carrier and cap upgrade to thrust screw	KIT 2751
		Carrier, cap and IAD shift cylinder upgrade	KIT 2706
		3200-G-1645 NoSpin diff. 3200-T-1814 NoSpin diff. 3200-B-1978 NoSpin diff.	See kits for standard carrier except KIT 2389 and KIT 2431 w hich apply to standard differential type carriers.



## AXLE MODEL TO CARRIER TO KIT CROSS REFERENCE

AXLE MODEL	BASE CARRIER	KIT DESCRIPTION	KIT NUMBER
RP-17-145	3200-X-1662 Pump 3200-V-1816 Pump 3200-H-1984 Pump	Carrier bearings and oil seals (Prior to 11/93)	KIT 4395
		Carrier bearings and oil seals (After 11/93)	KIT 4396
		Input brg cage shims & pinion inner brg cup shims	KIT 2429
		Pinion bearing spacers	KIT 2396
		Main differential nest w ith spider	KIT 2389
		Main differential nest w ithout spider	KIT 2431
		Ring gear to differential case bolts, nuts and w ashers	KIT 2317
		Output bearing snap ring spacers	KIT 576
		Inter-axle differential case and nest (Prior to 10/98)	KIT 2488
		Inter-axle differential case and nest (After 10/98)	KIT 2522
		Helical gears	KIT 2482
		Input shaft and pump upgrade	KIT 2835
		Carrier and cap upgrade to thrust screw	KIT 2753
		3200-X-1662 NoSpin diff. 3200-V-1816 NoSpin diff. 3200-H-1984 NoSpin diff.	See kits for carrier w ith pump except KIT 2389 and KIT 2431 w hich apply to standard differential type carriers.
RR-17-145	3200-L-1676 Standard 3200-Q-1785 Standard 3200-S-1865 Standard	See kits for same base carrier of RS-16-141	-
			-
			-
RS-19-145	3200-L-1676 Standard 3200-Q-1785 Standard 3200-S-1865 Standard	See kits for same base carrier of RS-16-141	-
			-
			-
RD-20-140	3200-G-1645 Standard 3200-T-1814 Standard 3200-B-1978 Standard	Carrier overhaul	KIT RD-20140NL
		Carrier bearings and oil seals (Prior to 11/93)	KIT 4355
		Carrier bearings and oils seals (updated input shaft)	KIT 4356
		Input brg cage shims & pinion inner brg cup shims	KIT 2429
		Pinion bearing spacers	KIT 2396
		Main differential nest w ith spider	KIT 2310
		Main differential nest w ithout spider	KIT 2311
		Ring gear to differential case bolts, nuts and w ashers	KIT 2317
		Output bearing snap ring spacers	KIT 530
		Inter-axle differential case and nest (Prior to 10/98)	KIT 2488
		Inter-axle differential case and nest (After 10/98)	KIT 2522
		Helical gears	KIT 2482
		Carrier and cap upgrade to thrust screw	KIT 2751
		Carrier, cap and IAD shift cylinder upgrade	KIT 2706
RR-20-140	3200-L-1676 Standard 3200-Q-1785 Standard 3200-S-1865 Standard	Carrier overhaul	KIT RS-145 1676
		Carrier bearings and oil seals	KIT 4400
		Pinion bearing cage shims	KIT 2313
		Pinion bearing spacers	KIT 2322
		Main differential nest w ith spider	KIT 2310
		Main differential nest w ithout spider	KIT 2311
		Ring gear to differential case bolts, nuts and w ashers	KIT 2317
		Carrier and cap upgrade to thrust screw	KIT 2756

## AXLE MODEL TO CARRIER TO KIT CROSS REFERENCE

AXLE MODEL	BASE CARRIER	KIT DESCRIPTION	KIT NUMBER	
MR-20-143	3200-W-2051 Standard	Pinion bearing shims	KIT 1647	
		Pinion bearing split spacers	KIT 2541	
		Carrier bearings and oil seals	KIT 4461	
		Main differential nest w ith spider	KIT 2310	
		Main differential nest w ithout spider	KIT 2311	
		Ring gear to differential case bolts, nuts and w ashers	KIT 2317	
MD-20-143	3200-G-1645 Standard	Carrier overhaul	KIT RD-20145NL	
RD-17-144	3200-T-1814 Standard	Carrier bearings and oil seals (Prior to 11/93)	KIT 4395	
RD-19-144	3200-F-1852 Standard	Carrier bearings and oil seals (After 11/93)	KIT 4396	
RD-20-145	3200-N-1860 Standard	Input brg cage shims & pinion inner brg cup shims	KIT 2429	
	3200-S-1917 Standard	Pinion bearing spacers	KIT 2396	
	3200-B-1978 Standard	Main differential nest w ith spider	KIT 2310	
	3200-C-1979 Standard	Main differential nest w ithout spider	KIT 2311	
		Ring gear to differential case bolts, nuts and w ashers	KIT 2317	
		Output bearing snap ring spacers	KIT 576	
		Inter-axle differential case and nest (Prior to 10/98)	KIT 2488	
		Inter-axle differential case and nest (After 10/98)	KIT 2522	
		Helical gears	KIT 2482	
		Carrier and cap upgrade to thrust screw	KIT 2751	
		Carrier, cap and IAD shift cylinder upgrade	KIT 2706	
		3200-M-1677 Diff. lock	Same as RD-20-145 standard except for the follow ing kits:	
		3200-U-1815 Diff. lock	Carrier overhaul	KIT RD-20145DL
		3200-R-1890 Diff. lock	Carrier bearings and oil seals (Prior to 11/93)	KIT 4405
		3200-E-1903 Diff. lock	Carrier bearings and oil seals (After 11/93)	KIT 4406
		3200-E-1981 Diff. lock	Shift kit (bolt on style main diff. lock)	KIT 2413
		Shift kit (screw on style main diff. lock)	KIT 2662	
MP-20-143	3200-L-1624 Pump w /lock	Carrier overhaul	KIT RD-20145DL	
RP-17-144	3200-W-1817 Pump w /lock	Carrier bearings and oil seals (Prior to 11/93)	KIT 4405	
RP-19-144	3200-P-1888 Pump w /lock	Carrier bearings and oil seals (After 11/93)	KIT 4406	
RP-20-145	3200-D-1902 Pump w /lock	Input brg cage shims & pinion inner brg cup shims	KIT 2429	
	3200-K-1987 Pump w /lock	Pinion bearing spacers	KIT 2396	
		Main differential nest w ith spider	KIT 2310	
		Main differential nest w ithout spider	KIT 2311	
		Ring gear to differential case bolts, nuts and w ashers	KIT 2317	
		Output bearing snap ring spacers	KIT 576	
		Inter-axle differential case and nest (Prior to 10/98)	KIT 2488	
		Inter-axle differential case and nest (After 10/98)	KIT 2522	
		Helical gears	KIT 2482	
		Carrier and cap upgrade to thrust screw	KIT 2754	
		Carrier, cap and IAD shift cylinder upgrade	KIT 2705	
		Input shaft and pump	KIT 2623	
		Shift kit (bolt on style main diff. lock)	KIT 2413	
		Shift kit (screw on style main diff. lock)	KIT 2662	

## AXLE MODEL TO CARRIER TO KIT CROSS REFERENCE

AXLE MODEL	BASE CARRIER	KIT DESCRIPTION	KIT NUMBER
MP-20-143	3200-X-1662 Pump	Carrier overhaul	KIT RD-20145NL
RP-17-144	3200-V-1816 Pump	Carrier bearings and oil seals (Prior to 11/93)	KIT 4395
RP-19-144	3200-G-1853 Pump	Carrier bearings and oil seals (After 11/93)	KIT 4396
RP-20-145	3200-H-1984 Pump	Input brg cage shims & pinion inner brg cup shims	KIT 2429
(cont)		Pinion bearing spacers	KIT 2396
		Main differential nest with spider	KIT 2310
		Main differential nest without spider	KIT 2311
		Ring gear to differential case bolts, nuts and washers	KIT 2317
		Output bearing snap ring spacers	KIT 576
		Inter-axle differential case and nest (Prior to 10/98)	KIT 2488
		Inter-axle differential case and nest (After 10/98)	KIT 2522
		Helical gears	KIT 2482
		Input shaft and pump upgrade	KIT 2623
		Carrier and cap upgrade to thrust screw	KIT 2753
	3200-X-1662 NoSpin diff. 3200-V-1816 NoSpin diff. 3200-H-1984 NoSpin diff. <b>WITH PUMP</b>	Same as pump with no lock with the following exceptions: KIT RD20145NL, KIT 2310 and KIT 2311 apply only to standard differential carriers, not used with NoSpin.	
RR-17-144	3200-L-1676 Standard	Carrier overhaul	KIT RS-145 1676
RR-19-144	3200-Q-1785 Standard	Carrier bearings and oil seals	KIT 4400
RR-20-145	3200-D-1850 Standard	Pinion brg cage shims (3200-L-1676 & 3200-M-1885)	KIT 2313
	3200-E-1851 Standard	Pinion bearing cage shims (all others)	KIT 1568
	3200-S-1865 Standard	Pinion bearing spacers	KIT 2322
	3200-M-1885 Standard	Main differential nest with spider	KIT 2310
		Main differential nest without spider	KIT 2311
		Ring gear to differential case bolts, nuts and washers	KIT 2317
		Carrier and cap upgrade to thrust screw	KIT 2756
	Same carriers as above but with No-Spin diff.	Same as above with the following exceptions: KIT RS-145 1676, KIT 2310 and KIT 2311 apply only to standard differential carriers, not used with NoSpin.	
	3200-X-1558 Diff. lock 3200-G-1879 Diff. lock	Carrier overhaul	KIT RS-145 1547
		Carrier bearings and oil seals	KIT 4390
		Pinion bearing cage shims	KIT 2313
		Pinion bearing spacers	KIT 2322
		Main differential nest with spider	KIT 2310
		Main differential nest without spider	KIT 2311
		Ring gear to differential case bolts, nuts and washers	KIT 2317
		Diff. lock actuator repair kit (bolt-on version)	KIT 2405
		Diff. lock actuator repair kit (screw-in version)	KIT 2662
		Carrier and cap upgrade to thrust screw	KIT 2755
RS-17-144	3200-L-1676 Standard	See kits for same base carriers of RR-20-145	
RS-19-144	3200-Q-1785 Standard		
RS-21-145	3200-D-1850 Standard		
	3200-E-1851 Standard		
	3200-S-1865 Standard		
	3200-M-1885 Standard		
	3200-L-1676 NoSpin diff.	See kits for same base carrier of RR-20-145	
	3200-X-1558 Diff. lock 3200-G-1879 Diff. lock	See kits for same base carriers of RR-20-145	

## AXLE MODEL TO CARRIER TO KIT CROSS REFERENCE

AXLE MODEL	BASE CARRIER	KIT DESCRIPTION	KIT NUMBER		
RS-17-144 RS-19-144 RS-21-145 (cont)	3200-R-1500 Diff. lock	Carrier overhaul	KIT RS-145 1500		
		Carrier bearings and oil seals	KIT 4385		
		Pinion bearing cage shims	KIT 2313		
		Pinion bearing spacers	KIT 2322		
		Main differential nest with spider	KIT 2310		
		Main differential nest without spider	KIT 2311		
		Ring gear to differential case bolts, nuts and washers	KIT 2317		
		Diff. lock actuator repair kit (bolt-on)	KIT 2405		
RD-22-145	3200-B-1874 Standard 3200-D-1980 Standard	Carrier bearings and oil seals (Prior to 11/93)	KIT 4395		
		Carrier bearings and oil seals (After 11/93)	KIT 4396		
		Input brg cage shims & pinion inner brg cup shims	KIT 2429		
		Pinion bearing spacers	KIT 2396		
		Main differential nest with spider	KIT 2696		
		Main differential nest without spider	KIT 2703		
		Main differential case upgrade 3.42 thru 4.11	KIT 2665		
		Main differential case upgrade 4.30 and slower	KIT 2647		
		Ring gear to differential case bolts, nuts and washers	KIT 2317		
		Output bearing snap ring spacers	KIT 576		
		Inter-axle differential case and nest (Prior to 10/98)	KIT 2488		
		Inter-axle differential case and nest (After 10/98)	KIT 2522		
		Helical gears	KIT 2482		
		Carrier and cap upgrade to thrust screw	KIT 2751		
	Carrier, cap and IAD shift cylinder upgrade	KIT 2706			
	3200-C-1875 Diff. lock 3200-G-1905 Diff. lock 3200-F-1982 Diff. lock	Same as RD-20-145 standard except for the following kits:			
		Carrier bearings and oil seals (Prior to 11/93)	KIT 4405		
		Carrier bearings and oil seals (After 11/93)	KIT 4406		
		Carrier, cap and IAD shift cylinder upgrade	KIT 2704		
		Main differential case upgrade 3.42 thru 4.11	KIT 2664		
		Main differential case upgrade 4.30 and slower	KIT 2648		
		Shift kit (bolt on style main diff. lock)	KIT 2413		
		Shift kit (screw on style main diff. lock)	KIT 2691		
		Carrier and cap upgrade to thrust screw	KIT 2752		
		RP-22-145	3200-E-1877 Pump w/lock 3200-H-1906 Pump w/lock 3200-M-1911 Pump w/lock 3200-T-1918 Pump w/lock	Carrier bearings and oil seals (Prior to 11/93)	KIT 4405
				Carrier bearings and oil seals (After 11/93)	KIT 4406
Input brg cage shims & pinion inner brg cup shims				KIT 2429	
Pinion bearing spacers	KIT 2396				
Main differential nest with spider	KIT 2696				
Main differential nest without spider	KIT 2703				
Main differential case upgrade 3.42 thru 4.11	KIT 2664				
Main differential case upgrade 4.30 and slower	KIT 2648				
Ring gear to differential case bolts, nuts and washers	KIT 2317				
Output bearing snap ring spacers	KIT 576				
Inter-axle differential case and nest (Prior to 10/98)	KIT 2488				
Inter-axle differential case and nest (After 10/98)	KIT 2522				
Helical gears	KIT 2482				
Carrier, cap and IAD shift cylinder upgrade	KIT 2705				
Input shaft and pump	KIT 2623				
Shift kit (bolt on style main diff. lock)	KIT 2413				
Shift kit (screw on style main diff. lock)	KIT 2691				
Carrier and cap upgrade to thrust screw	KIT 2754				

## AXLE MODEL TO CARRIER TO KIT CROSS REFERENCE

AXLE MODEL	BASE CARRIER	KIT DESCRIPTION	KIT NUMBER	
RP-22-145 (cont)	3200-D-1876 Pump 3200-P-1914 Pump 3200-J-1986 Pump	Carrier bearings and oil seals (Prior to 11/93)	KIT 4395	
		Carrier bearings and oil seals (After 11/93)	KIT 4396	
		Input brg cage shims & pinion inner brg cup shims	KIT 2429	
		Pinion bearing spacers	KIT 2396	
		Main differential nest with spider	KIT 2696	
		Main differential nest without spider	KIT 2703	
		Main differential case upgrade 3.42 thru 4.11	KIT 2665	
		Main differential case upgrade 4.30 and slower	KIT 2647	
		Ring gear to differential case bolts, nuts and washers	KIT 2317	
		Output bearing snap ring spacers	KIT 576	
		Inter-axle differential case and nest (Prior to 10/98)	KIT 2488	
		Inter-axle differential case and nest (After 10/98)	KIT 2522	
		Helical gears	KIT 2482	
		Input shaft and pump upgrade	KIT 2623	
		Carrier and cap upgrade to thrust screw	KIT 2753	
		Same carriers as above but with No-Spin diff.	Same as above with the following exceptions: KIT RD20145NL, KIT 2310 and KIT 2311 apply only to standard differential carriers, not used with NoSpin.	
		RR-22-145	3200-A-1873 Standard	Carrier bearings and oil seals
Pinion bearing cage shims	KIT 2313			
Pinion bearing spacers	KIT 2322			
Main differential nest with spider	KIT 2696			
Main differential nest without spider	KIT 2703			
Main differential case upgrade 3.42 thru 4.11	KIT 2665			
Main differential case upgrade 4.30 and slower	KIT 2647			
Ring gear to differential case bolts, nuts and washers	KIT 2317			
Carrier and cap upgrade to thrust screw	KIT 2756			
Same carriers as above but with No-Spin diff.	Same as above with the following exceptions: KIT RS-145 1676, KIT 2310 and KIT 2311 apply only to standard differential carriers, not used with NoSpin.			
3200-F-1904 Diff. lock	Carrier bearings and oil seals		KIT 4390	
	Pinion bearing cage shims		KIT 2313	
	Pinion bearing spacers		KIT 2322	
	Main differential nest with spider		KIT 2696	
	Main differential nest without spider		KIT 2703	
	Main differential case upgrade 3.42 thru 4.11		KIT 2664	
	Main differential case upgrade 4.30 and slower		KIT 2648	
	Ring gear to differential case bolts, nuts and washers	KIT 2317		
Diff. lock actuator repair kit (bolt-on)	KIT 2405			
Carrier and cap upgrade to thrust screw	KIT 2755			

# SERVICE KITS

## KIT RD20140NL

ITEM	PART NUMBER	QTY.	DESCRIPTION	REMARKS
1	KIT 2310	1	Main Diff. Kit with Spider	Without diff. lock, old style welded IAD RD-20-140
2	KIT 2396	1	Spacer Kit	
3	KIT 2429	1	Shim Kit	
4	KIT 576	1	Snap Ring Kit	
5	KIT 2488	1	IAD Kit	
6	40-X-1145	1	Nut	
7	KIT 2637	1	Input Nut and Washer Kit	
8	KIT 4395	1	Bearing & Seal Kit	
9	JM-511945	1	Bearing Cone	

## KIT RD20145DL

ITEM	PART NUMBER	QTY.	DESCRIPTION	REMARKS
1	KIT 2310	1	Main Diff. Kit with Spider	With diff. lock, old style welded IAD. Later model bolted IAD carriers can use this kit. RD-17-144, RD-19-144, RD-20-145, RP-17-144, RP-19-144, RP-20-145
2	KIT 2396	1	Spacer Kit	
3	KIT 2429	1	Shim Kit	
4	KIT 576	1	Snap Ring Kit	
5	KIT 2488	1	IAD Kit	
6	40-X-1145	1	Nut	
7	KIT 2637	1	Input Nut and Washer Kit	
8	KIT 4405	1	Bearing & Seal Kit	
9	JM-511945	1	Bearing Cone	
10	40-X-1233	1	Lock Nut	
11	1229-N-1730	1	Washer	
12	A1-1205-X-2728	1	Oil Seal Assembly	

## KIT RD20145NL

ITEM	PART NUMBER	QTY.	DESCRIPTION	REMARKS
1	KIT 2310	1	Main Diff. Kit with Spider	Without diff. lock, old style welded IAD. Later model bolted IAD carriers can use this kit. RD-17-144, RD-19-144, RD-20-145, RP-17-144, RP-19-144, RP-20-145
2	KIT 2396	1	Spacer Kit	
3	KIT 2429	1	Shim Kit	
4	KIT 576	1	Snap Ring Kit	
5	KIT 2488	1	IAD Kit	
6	40-X-1145	1	Nut	
7	KIT 2637	2	Input Nut and Washer Kit	
8	KIT 4395	1	Bearing & Seal Kit	
9	JM-511945	1	Bearing Cone	
10	40-X-1233	1	Lock Nut	
11	1229-N-1730	1	Washer	
12	A1-1205-X-2728	1	Oil Seal Assembly	

## KIT RR22145 1873

ITEM	PART NUMBER	QTY.	DESCRIPTION	REMARKS
1	KIT 2696	1	Main Diff. Kit with Spider	Less diff lock. RR-22-145
2	KIT 2637	1	Input Nut and Washer Kit	
3	KIT 2322	1	Spacer Kit	
4	KIT 1568	1	Shim Kit	
5	KIT 4400	1	Bearing & Seal Kit	

## KIT RS145 1500

ITEM	PART NUMBER	QTY.	DESCRIPTION	REMARKS
1	KIT 2310	1	Main Diff. Kit with Spider	For 3200-R-1500 DCDL carriers. RR-20-145, RS-21-145
2	KIT 2637	1	Input Nut and Washer Kit	
3	KIT 2322	1	Spacer Kit	
4	KIT 2313	1	Shim Kit	
5	KIT 4385	1	Bearing & Seal Kit	

## KIT RS145 1547

ITEM	PART NUMBER	QTY.	DESCRIPTION	REMARKS
1	KIT 2310	1	Main Diff. Kit with Spider	For DCDL carriers other than 3200-R-1500. RR-17-144, RR-19-144, RR-20-145, RS-17-144, RS-19-144, RS-21-145
2	KIT 2637	1	Input Nut and Washer Kit	
3	KIT 2322	1	Spacer Kit	
4	KIT 2313	1	Shim Kit	
5	KIT 4390	1	Bearing & Seal Kit	

# SERVICE KITS

## KIT RS145 1676

ITEM	PART NUMBER	QTY.	DESCRIPTION	REMARKS
1	KIT 2310	1	Main Diff. Kit with Spider	Non-DCDL carriers. RR-20-140, RR-20-145, RS-17-144, RS-19-144
2	KIT 2637	1	Input Nut and Washer Kit	
3	KIT 2322	1	Spacer Kit	
4	KIT 2313	1	Shim Kit	
5	KIT 4400	1	Bearing & Seal Kit	
6	KIT 1568	1	Shim Kit	

## KIT RS17140

ITEM	PART NUMBER	QTY.	DESCRIPTION	REMARKS
1	KIT 2308	1	Main Diff. Kit with Spider	RS-16-140, RS-17-140
2	KIT 2636	1	Fastener Kit	
3	KIT 2321	1	Spacer Kit	
4	KIT 2313	1	Shim Kit	
5	KIT 4345	1	Bearing & Seal Kit	

## KIT 530

ITEM	PART NUMBER	QTY.	DESCRIPTION	REMARKS
1	1229-A-2237	1	Snap Ring - 3.94mm/.155 in.	Output shaft snap ring kit RD-20-140
2	1229-B-2238	1	Snap Ring - 4.01mm/.158 in.	
3	1229-C-2239	1	Snap Ring - 4.09mm/.161 in.	
4	1229-D-2240	1	Snap Ring - 4.17mm/.164 in.	
5	1229-E-2241	1	Snap Ring - 4.24mm/.167 in.	
6	1229-F-2242	1	Snap Ring - 4.32mm/.170 in.	
7	1229-G-2243	1	Snap Ring - 4.39mm/.173 in.	
8	1229-H-2244	1	Snap Ring - 4.47mm/.176 in.	
9	1229-J-2246	1	Snap Ring - 4.55mm/.179 in.	
10	1229-K-2247	1	Snap Ring - 4.62mm/.182 in.	

## KIT 576

ITEM	PART NUMBER	QTY.	DESCRIPTION	REMARKS
1	1229-P-2590	1	Ring-Snap	Output shaft snap ring kit MD-20-143, MP-20-143, RD-17-144, RD-17-145, RD-19-144, RD-20-145, RD-22-145, RP-17-144, RP-17-145, RP-19-144, RP-20-145, RP-22-145
2	1229-Q-2591	1	Ring-Snap	
3	1229-R-2592	1	Ring-Snap	
4	1229-S-2593	1	Ring-Snap	
5	1229-T-2594	1	Ring-Snap	
6	1229-U-2595	1	Ring-Snap	
7	1229-V-2596	1	Ring-Snap	
8	1229-W-2597	1	Ring-Snap	
9	1229-X-2598	1	Ring-Snap	
10	1229-Y-2599	1	Ring-Snap	

## KIT 1568

ITEM	PART NUMBER	QTY.	DESCRIPTION	REMARKS
1	2203-C-8115	1	Shim - .075mm/.003 in.	3200-S-1865 or all single or rear/rear models using pinion bearing shim OD 8.5" 140 Series
2	2203-D-8116	3	Shim - .125mm/.005 in.	
3	2203-E-8117	4	Shim - .250mm/.010 in.	
4	2203-B-9804	1	Shim - .500mm/.020 in.	

## KIT 1647

ITEM	PART NUMBER	QTY.	DESCRIPTION	REMARKS
1	2203-F-2788	3	Shim - .075mm/.003 in.	For Amboid drive axle. MR-20-143M, RD-17-144, RD-17-145, RD-19-144, RD-19-145, RD-20-145, RD-22-145, RP-17-144, RP-17-145, RP-19-144, RP-19-145, RP-20-145, RP-22-145
2	2203-G-2789	2	Shim - .125mm/.005 in.	
3	2203-H-2790	4	Shim - .250mm/.010 in.	

## KIT 2308

ITEM	PART NUMBER	QTY.	DESCRIPTION	REMARKS
1	2233-M-1027	4	Differential Pinion, Finished	With diff. spider (1.85"-36 spline side gear). Original design. RS-16-140, RS-17-140
2	2234-T-1086	2	Differential Side Gear, Finished	
3	3278-D-82	1	Differential Spider	
4	1229-Z-3172	2	Thrust Washer	
5	1229-L-1026	4	Thrust Washer	

# SERVICE KITS

## KIT 2309

ITEM	PART NUMBER	QTY.	DESCRIPTION	REMARKS
1	2233-M-1027	4	Differential Pinion, Finished	Less diff. spider (1.85"-36 spline side gear). Original design. RS-16-140, RS-17-140
2	2234-T-1086	2	Differential Side Gear, Finished	
3	1229-Z-3172	2	Thrust Washer	
4	1229-L-1026	4	Thrust Washer	

## KIT 2310

ITEM	PART NUMBER	QTY.	DESCRIPTION	REMARKS
1	2233-J-1024	4	Differential Pinion, Finished	With diff. spider (2.10"-41 spline side gear). MD-20-143, MP-20-143, MR-20-143, RD/RP/RR-17-144, RD/RP/RR-19-144, RD/RR-20-140, RD/RP/RR-20-145, RS-17-144, RS-19-144, RS-21-145
2	2234-U-1269	2	Differential Side Gear, Finished	
3	3278-S-305	1	Differential Spider	
4	1229-V-4624	2	Thrust Washer	
5	1229-R-1032	4	Thrust Washer	

## KIT 2311

ITEM	PART NUMBER	QTY.	DESCRIPTION	REMARKS
1	2233-J-1024	4	Differential Pinion	Less diff. spider (2.10"-41 spline side gear). MD/MP/MR-20-143, RD/RP/RR-17-144, RD/RP/RR-19-144, RD/RR-20-140, RD/RP/RR-20-145, RS-17-144, RS-19-144, RS-21-145
2	2234-U-1269	2	Differential Side Gear, Finished	
3	1229-V-4624	2	Thrust Washer	
4	1229-R-1032	4	Thrust Washer	

## KIT 2313

ITEM	PART NUMBER	QTY.	DESCRIPTION	REMARKS
1	2803-Q-2851	3	Shim - .075mm/.003 in.	3200-L-1676 or all single or rear/rear models using pinion bearing shim OD 9.62". 140 Series
2	2803-R-2852	2	Shim - .125mm/.005 in.	
3	2803-S-2853	4	Shim - .250mm/.010 in.	
4	2803-T-2854	1	Shim - .500mm/.020 in.	

## KIT 2317

ITEM	PART NUMBER	QTY.	DESCRIPTION	REMARKS
1	41-X-1216	12	Capscrew	Gear to case bolt kit (17.0 mm bolts prior to 4-88). MD/MP/MR-20-143, RD/RP/RR-17-144, RD/RP/RR-17-145, RD/RP/RR-19-144, RD/RR-20-140, RD/RP/RR-20-145, RD/RP/RR-22-145, RS-16-140, RS-16-141, RS-17-140, RS-17-141, RS-17-144, RS-17-145, RS-19-144, RS-19-145, RS-21-145
2	1229-U-1503	12	Washer-Flat	
3	40-X-1182	12	Lock Nut	

## KIT 2321

ITEM	PART NUMBER	QTY.	DESCRIPTION	REMARKS
1	2203-V-9486	2	Spacer - 8.35mm/.329 in.	Pinion bearing spacers RS-16-140, RS-17-140
2	2203-W-9487	2	Spacer - 8.38mm/.330 in.	
3	2203-X-9488	2	Spacer - 8.40mm/.331 in.	
4	2203-Y-9489	2	Spacer - 8.43mm/.332 in.	
5	2203-Z-9490	2	Spacer - 8.45mm/.333 in.	
6	2203-A-9491	2	Spacer - 8.58mm/.338 in.	
7	2203-B-9492	2	Spacer - 8.70mm/.343 in.	
8	2203-C-9493	2	Spacer - 8.73mm/.344 in.	
9	2203-D-9494	2	Spacer - 8.75mm/.345 in.	
10	2203-E-9495	2	Spacer - 8.78mm/.346 in.	
11	2203-F-9496	2	Spacer - 8.80mm/.347 in.	

## KIT 2322

ITEM	PART NUMBER	QTY.	DESCRIPTION	REMARKS
1	2203-J-9474	2	Spacer - 8.75mm/.345 in.	Pinion bearing spacers RR-17-144, RR-17-145, RR-19-144, RR-20-140, RR-20-145, RR-22-145, RS-16-141, RS-17-141, RS-17-144, RS-19-144, RS-19-145, RS-21-145
2	2203-K-9475	2	Spacer - 8.78mm/.346 in.	
3	2203-L-9476	2	Spacer - 8.80mm/.347 in.	
4	2203-M-9477	2	Spacer - 8.83mm/.348 in.	
5	2203-N-9478	2	Spacer - 8.85mm/.349 in.	
6	2203-P-9480	2	Spacer - 8.98mm/.354 in.	
7	2203-Q-9481	2	Spacer - 9.10mm/.354 in.	
8	2203-R-9482	2	Spacer - 9.13mm/.359 in.	
9	2203-S-9483	2	Spacer - 9.15mm/.360 in.	
10	2203-T-9484	2	Spacer - 9.18mm/.361 in.	
11	2203-U-9485	2	Spacer - 9.20mm/.362 in.	



# SERVICE KITS

## KIT 2389

ITEM	PART NUMBER	QTY.	DESCRIPTION	REMARKS
1	2233-J-1024	4	Differential Pinion	With diff. spider (2.00"-39 spline side gear). RD-17-145, RP-17-145, RS-16-140, RS-16-141, RS-17-140, RS-17-141
2	2234-V-1270	2	Differential Side Gear, Finished	
3	3278-S-305	1	Differential Spider	
4	1229-V-4624	2	Thrust Washer	
5	1229-R-1032	4	Thrust Washer	

## KIT 2396

ITEM	PART NUMBER	QTY.	DESCRIPTION	REMARKS
1	2203-D-9806	2	Spacer - 5.30mm/.209 in.	Pinion bearing spacers MD-20-143, MP-20-143, RD-17-145, RD-20-140, RD-20-145, RD-22-145, RP-17-145, RP-20-145, RP-22-145
2	2203-E-9807	2	Spacer - 5.33mm/.210 in.	
3	2203-F-9808	2	Spacer - 5.35mm/.211 in.	
4	2203-G-9809	2	Spacer - 5.38mm/.212 in.	
5	2203-H-9810	2	Spacer - 5.40mm/.213 in.	
6	2203-J-9812	2	Spacer - 5.50mm/.217 in.	
7	2203-K-9813	2	Spacer - 5.60mm/.220 in.	
8	2203-L-9814	2	Spacer - 5.70mm/.224 in.	
9	2203-M-9815	2	Spacer - 5.80mm/.228 in.	
10	2203-N-9816	2	Spacer - 5.90mm/.232 in.	
11	2203-P-9818	2	Spacer - 6.00mm/.236 in.	
12	2203-Q-9819	2	Spacer - 6.10mm/.240 in.	
13	2203-R-9820	2	Spacer - 6.13mm/.241 in.	
14	2203-S-9821	2	Spacer - 6.15mm/.242 in.	
15	2203-T-9822	2	Spacer - 6.18mm/.243 in.	
16	2203-U-9823	2	Spacer - 6.20mm/.244 in.	

## KIT 2405

ITEM	PART NUMBER	QTY.	DESCRIPTION	REMARKS
1	3196-F-32	1	Tube,Fin.	Minor repair kit for original design main differential lock carriers. RD-20-145, RP-20-145, RP-22-145, RR-20-145, RR-22-145, RS-21-145
2	2230-N-170	1	Piston	
3	5-X-1153	1	O-Ring	
4	2208-H-944	1	Gasket	
5	41-X-1364	4	Capscrew	
6	MWA-506	4	Washer	

## KIT 2413

ITEM	PART NUMBER	QTY.	DESCRIPTION	REMARKS
1	3296-W-1167	1	Shift Fork, Finished	RD-20-145, RD-22-145, RP-20-145, RP-22-145
2	3107-D-1018	1	Clutch Collar	
3	2244-L-1026	1	Shift Shaft	
4	43-X-1006	1	Roll Pin	
5	2258-L-714	1	Spring	
6	3196-F-32	1	Tube,Fin.	
7	2230-N-170	1	Piston	
8	5-X-1153	1	O-Ring	
9	2208-H-944	1	Gasket	
10	3266-F-1020	1	Cover,Fin.	
11	MWA-506	4	Washer	
12	41-X-1364	4	Capscrew	
13	2208-L-1000	1	Gasket	
14	MS-210016-1	1	Capscrew	
15	41-X-1333	1	Capscrew	
16	3237-W-1167	1	Switch Assembly Sensor	
17	1227-P-1056	1	Sensor Adjusting Nut	
18	2257-M-1235	1	Sensor/Switch Clip	

# SERVICE KITS

## KIT 2420

ITEM	PART NUMBER	QTY.	DESCRIPTION	REMARKS
1	2233-U-1035	4	Differential Pinion	IAD nest kit for the bolted IAD. Includes forward and rear side gears. For carriers built after 10/98. MD-20-143, MP-20-143, RD-17-144, RP-17-144, RD-19-144, RP-19-144, RD-17-145, RP-17-145, RD-19-145, RP-19-145, RD-20-145, RP-20-145
2	2234-R-1188	1	Differential Side Gear, Finished	
3	3892-S-5843	1	Forward IAD Gear	
4	2297-E-5335	1	Snap Ring	
5	3278-A-1119	1	Differential Spider, Finished	
6	1229-T-1606	4	Thrust Washer	
7	1229-S-4985	1	Thrust Washer	

## KIT 2429

ITEM	PART NUMBER	QTY.	DESCRIPTION	REMARKS
1	2203-K-9241	1	Shim - .076mm/.003 in.	MD-20-143, MP-20-143, RD-17-144, RD-17-145, RP-17-144, RD-20-140, RD-20-145, RD-22-145, RP-17-144, RP-17-145, RP-19-144, RP-20-145, RP-22-145
2	2203-L-9242	1	Shim - .127mm/.005 in.	
3	2203-M-9243	4	Shim - .254mm/.010 in.	
4	2203-F-2788	1	Shim - .075mm/.003 in.	
5	2203-G-2789	1	Shim - .125mm/.005 in.	
6	2203-H-2790	4	Shim - .250mm/.010 in.	

## KIT 2431

ITEM	PART NUMBER	QTY.	DESCRIPTION	REMARKS
1	2233-J-1024	4	Differential Pinion	Less diff. spider (2.00"-39 spline side gear). RD-17-145, RP-17-145, RR-17-145, RS-16-140, RS-16-141, RS-17-140, RS-17-141, RS-19-145
2	2234-V-1270	2	Differential Side Gear, Finished	
3	1229-V-4624	2	Thrust Washer	
4	1229-R-1032	4	Thrust Washer	

## KIT 2445

ITEM	PART NUMBER	QTY.	DESCRIPTION	REMARKS
1	3261-R-1084	1	Shift Unit Cylinder, Finished	For "reverse-air" Navistar only. 140 Series
2	3266-Q-1161	1	Cover, Finished	
3	2230-D-1096	1	Piston	
4	2244-D-1070	1	Differential Lock Out Push Rod	
5	2258-E-1175	1	Spring	
6	5-X-1195	1	O-Ring	
7	5-X-1196	1	O-Ring	
8	5-X-1197	1	O-Ring	
9	1229-P-4280	1	Snap Ring	
10	1229-W-1245	1	Snap Ring	
11	MS-206060-1	4	Capscrew	
12	41-X-1080	2	Special Screw	
13	MWA-506	6	Washer	

## KIT 2446

ITEM	PART NUMBER	QTY.	DESCRIPTION	REMARKS
1	2258-E-1175	1	Spring	For "reverse-air" Navistar only. 140 Series
2	2230-D-1096	1	Piston	
3	5-X-1195	1	O-Ring	
4	5-X-1196	1	O-Ring	
5	5-X-1197	1	O-Ring	
6	1229-P-4280	1	Snap Ring	
7	1229-W-1245	1	Snap Ring	

# SERVICE KITS

## KIT 2482

ITEM	PART NUMBER	QTY.	DESCRIPTION	REMARKS
1	3892-S-5843	1	Forward IAD Gear	MD-20-143, MP-20-143, RD-17-145,
2	3892-N-4902	1	Helical Driven Gear	RD-20-140, RD-20-145, RD-22-145,
3	1229-S-4985	1	Thrust Washer	RP-17-145, RP-22-145

## KIT 2488

ITEM	PART NUMBER	QTY.	DESCRIPTION	REMARKS
1	A-3235-W-2025	1	Interaxle Differential Case & Nest Assembly	Old style IAD (1.77"-34 spline side gear).
2	2234-R-1188	1	Differential Side Gear, Finished	Services all forward carriers built before 10/98.
3	3892-S-5843	1	Forward IAD Gear	After 10/98 use KIT 2522. RD-17-145,
4	1229-S-4985	1	Thrust Washer	RD-20-140, RD-20-145, RD-22-145,
5	2297-E-5335	1	Snap Ring	RP-17-145, RP-20-145, RP-22-145

## KIT 2511

ITEM	PART NUMBER	QTY.	DESCRIPTION	REMARKS
1	3216-S-4361	2	Tube Finished	ABS carrier 2"-39 spline
2	42-X-1248	2	Special Washer	RD-20-145, RP-20-145, RR-20-145
3	1229-H-4428	2	Snap Ring	

## KIT 2512

ITEM	PART NUMBER	QTY.	DESCRIPTION	REMARKS
1	3216-Q-4359	2	Tube, Fin.	ABS carrier 2.10"-41 spline
2	42-X-1248	2	Special Washer	RD-17-145, RR-17-145
3	1229-H-4428	2	Snap Ring	

## KIT 2522

ITEM	PART NUMBER	QTY.	DESCRIPTION	REMARKS
1	A-3235-N-2380	1	Interaxle Differential Case & Nest Assembly	New style IAD. Use for carriers built after 10/98.
2	2234-R-1188	1	Differential Side Gear, Finished	MD-20-143, MP-20-143, RD-17-144,
3	3892-S-5843	1	Forward IAD Gear	RD-17-145, RD-19-144, RD-20-140,
4	1229-S-4985	1	Thrust Washer	RD-20-145, RD-22-145, RP-17-144,
5	2297-E-5335	1	Snap Ring	RP-17-145, RP-19-144, RP-20-145, RP-22-145

## KIT 2541

ITEM	PART NUMBER	QTY.	DESCRIPTION	REMARKS
1	1244-M-2431	1	Spacer - 9.40mm/.370 in.	For Amboid drive axle. MR-20-143
2	1244-N-2432	1	Spacer - 9.43mm/.371 in.	
3	1244-P-2434	1	Spacer - 9.45mm/.372 in.	
4	1244-Q-2435	1	Spacer - 9.48mm/.373 in.	
5	1244-R-2436	1	Spacer - 9.50mm/.374 in.	
6	1244-S-2437	1	Spacer - 9.60mm/.378 in.	
7	1244-T-2438	1	Spacer - 9.70mm/.382 in.	
8	1244-U-2439	1	Spacer - 9.80mm/.386 in.	
9	1244-V-2440	1	Spacer - 9.90mm/.390 in.	
10	1244-W-2441	1	Spacer - 10.00mm/.394 in.	
11	1244-X-2442	1	Spacer - 10.10mm/.398 in.	
12	1244-Y-2443	1	Spacer - 10.20mm/.402 in.	
13	1244-Z-2444	1	Spacer - 10.23mm/.403 in.	
14	1244-A-2445	1	Spacer - 10.25mm/.404 in.	
15	1244-B-2446	1	Spacer - 10.28mm/.405 in.	
16	1244-C-2447	1	Spacer - 10.30mm/.406 in.	

## KIT 2636

ITEM	PART NUMBER	QTY.	DESCRIPTION	REMARKS
1	40-X-1236	1	Lock Nut	M32 x 1.5 nut thread. Rear input, front output.
2	1229-A-2653	1	Washer-Flat	140 Series

## KIT 2637

ITEM	PART NUMBER	QTY.	DESCRIPTION	REMARKS
1	40-X-1237	1	Lock Nut	M39 x 1.5 nut thread. Front input, rear input.
2	1229-T-1736	1	Washer-Flat	140 Series

## KIT 2638

ITEM	PART NUMBER	QTY.	DESCRIPTION	REMARKS
1	40-X-1233	1	Lock Nut	M45 x 1.5 nut thread. Front input.
2	1229-W-4521	1	Washer	140 Series

# SERVICE KITS

## KIT 2647

ITEM	PART NUMBER	QTY.	DESCRIPTION	REMARKS
1	3235-T-2152	1	Half Flange Differential Case, Finished	Diff. case and spider update kit. For 44,000 lb. tandems without differential lock. 4.30 ratio and slower. RD-22-145, RP-22-145, RR-22-145
2	3235-U-2153	1	Plain Half Differential Spider, Finished	
3	41-X-1327	16	Special Screw	
4	1229-C-1511	16	Washer-Flat	
5	3278-Y-1117F	1	Differential Spider, Finished	

## KIT 2648

ITEM	PART NUMBER	QTY.	DESCRIPTION	REMARKS
1	3235-T-2152	1	Half Flange Differential Case, Finished	Diff. case and spider update kit. For 44,000 lb. tandems with differential lock. 4.30 ratio and slower. RD-22-145, RP-22-145, RR-22-145
2	3235-V-2154	1	Plain Half Differential Case, Finished	
3	41-X-1327	16	Special Screw	
4	1229-C-1511	16	Washer-Flat	
5	3278-Y-1117F	1	Differential Spider, Finished	

## KIT 2662

ITEM	PART NUMBER	QTY.	DESCRIPTION	REMARKS
1	3296-Z-1170	1	Shift Fork, Finished	Screw in air shift cage kit for post 11/93 DCDL 145 series carriers RD-17-144, RD-19-144, RD-20-145, RD-22-145, RP-17-144, RP-19-144, RP-20-145, RP-22-145, RR-17-144, RR-19-144, RR-20-145, RR-22-145, RS-17-144, RS-19-144, RS-21-145
2	3107-D-1018	1	Clutch Collar	
3	3237-W-1167	1	Switch Assembly Sensor	
4	2257-M-1235	1	Sensor/Switch Clip	
5	2258-N-1262	1	Spring	
6	5-X-521	1	O-Ring	
7	A-3261-A-1067	1	DCDL Shift Cylinder	
8	41-X-1368	1	Caging Bolt	
9	2244-Z-1222	1	Push Rod	

## KIT 2664

ITEM	PART NUMBER	QTY.	DESCRIPTION	REMARKS
1	3235-D-2188	1	Half Flange Differential Case, Finished	Diff. case and spider update kit. For 44,000 lb. tandems with differential lock. Ratios 3.42 thru 4.11. RD-22-145, RP-22-145, RR-22-145
2	3235-V-2154	1	Plain Half Differential Case, Finished	
3	41-X-1327	16	Special Screw	
4	1229-C-1511	16	Washer-Flat	
5	3278-Y-1117F	1	Differential Spider, Finished	

## KIT 2665

ITEM	PART NUMBER	QTY.	DESCRIPTION	REMARKS
1	3235-D-2188	1	Half Flange Differential Case, Finished	Diff. case and spider update kit. For 44,000 lb. tandems with differential lock. Ratios 3.42 thru 4.11. RD-22-145, RP-22-145, RR-22-145
2	3235-U-2153	1	Plain Half Differential Spider, Finished	
3	41-X-1327	16	Special Screw	
4	1229-C-1511	16	Washer-Flat	
5	3278-Y-1117F	1	Differential Spider, Finished	

## KIT 2668

ITEM	PART NUMBER	QTY.	DESCRIPTION	REMARKS
1	10-X-1594	7	Screw-Special	Carrier to housing capscrew kit. 145 Series Forward
2	10-X-1597	3	Screw-Special	
3	1229-W-1557	12	Washer-Hardened	

## KIT 2686

ITEM	PART NUMBER	QTY.	DESCRIPTION	REMARKS
1	2244-D-1070	1	Differential Lock Out Push Rod	Navistar "reverse air" shift RD-20-145, RD-22-145, RP-20-145, RP-22-145
2	3266-Q-1161	1	Cover, Finished	

## KIT 2691

ITEM	PART NUMBER	QTY.	DESCRIPTION	REMARKS
1	A-3261-A-1067	1	DCDL Shift Cylinder	Main diff. lock, screw-in shift, Services all new style screw-in type main differential lock carriers. MD-20-143, MP-20-143, RD-17-144, RD-19-144, RD-20-145, RD-22-145, RP-17-144, RP-19-144, RP-20-145, RP-22-145, RR-17-144, RR-19-144, RR-20-145, RS-17-144, RS-19-144, RS-21-145
2	2244-Z-1222	1	Push Rod	
3	41-X-1368	1	Caging Bolt	
4	5-X-521	1	O-Ring	

# SERVICE KITS

## KIT 2696

ITEM	PART NUMBER	QTY.	DESCRIPTION	REMARKS
1	2233-X-1116	4	Differential Pinion	With diff. spider (2.10"-41 spline side gear) RD-22-145, RP-22-145, RR-22-145
2	2234-X-1272	2	Differential Side Gear, Finished	
3	3278-Y-1117F	1	Differential Spider, Finished	
4	1229-V-4624	2	Thrust Washer	
5	1229-R-1032	4	Thrust Washer	

## KIT 2703

ITEM	PART NUMBER	QTY.	DESCRIPTION	REMARKS
1	2233-X-1116	4	Differential Pinion	Less diff. spider (2.10"-41 spline side gear) RD-22-145, RP-22-145, RR-22-145
2	2234-X-1272	2	Differential Side Gear, Finished	
3	1229-V-4624	2	Thrust Washer	
4	1229-R-1032	4	Thrust Washer	

## KIT 2704

ITEM	PART NUMBER	QTY.	DESCRIPTION	REMARKS
1	KIT 2752	1	Update Kit	Carrier and cap update kit (with diff. lock, less pump) RD-20-145, RD-22-145
2	KIT 2825	1	Shift Kit	

## KIT 2705

ITEM	PART NUMBER	QTY.	DESCRIPTION	REMARKS
1	KIT 2754	1	Update Kit	Carrier and cap update kit (with diff. lock, with pump) RD-20-145, RP-22-145
2	KIT 2825	1	Shift Kit	

## KIT 2706

ITEM	PART NUMBER	QTY.	DESCRIPTION	REMARKS
1	KIT 2751	1	Update Kit	Carrier and cap update kit (less diff. lock, less pump) MD-20-143, RD-17-145, RD-20-140, RD-20-145, RD-22-145
2	KIT 2825	1	Shift Kit	

## KIT 2709

ITEM	PART NUMBER	QTY.	DESCRIPTION	REMARKS
1	5-X-1195	1	O-Ring	Navistar "reverse air" shift RD-17-145, RD-20-140, RD-20-145, RD-22-145, RP-20-145, RP-22-145
2	5-X-1196	1	O-Ring	
3	5-X-1197	1	O-Ring	
4	1229-P-4280	1	Snap Ring	

## KIT 2730

ITEM	PART NUMBER	QTY.	DESCRIPTION	REMARKS
1	A2-3200-L-1676	1	Differential Carrier and Cap Assembly	Carrier and cap update kit (with diff case assembly, all ratios except 3.91 and 4.10) less diff. lock RR-20-145, RP-22-145, RS-21-145
2	A8-3235-W-1843	1	Case Assy-Diff	
3	JM-716610	1	Bearing Cup	
4	JM-716649	1	Bearing Cone	
5	2214-C-1095	1	Bearing Adjuster Ring, Finished	

## KIT 2743

ITEM	PART NUMBER	QTY.	DESCRIPTION	REMARKS
1	A-3235-W-2025	1	Interaxle Differential Case & Nest Assembly	Inter-axle diff., shift fork and clutch collar, old style RD-17-145, RD-20-140, RD-20-145, RD-22-145, RP-17-145, RP-20-145, RP-22-145
2	3107-M-1183	1	Clutch Collar	
3	3296-Z-1326	1	Shift Fork, Finished	

## KIT 2747

ITEM	PART NUMBER	QTY.	DESCRIPTION	REMARKS
1	A2-3200-E-1981	1	Differential Carrier and Cap Assembly	Carrier and cap update kit (with diff. lock, less pump) RD-20-145
2	KIT 2691	1	Shift Cylinder Kit	
3	2206-L-1156	1	Elbow Fitting	
4	3296-Z-1170	1	Shift Fork, Finished	
5	2258-N-1262	1	Spring	

# SERVICE KITS

## KIT 2750

ITEM	PART NUMBER	QTY.	DESCRIPTION	REMARKS
1	A-3261-A-1067	1	DCDL Shift Cylinder	Main diff. lock, screw-in shift, Services all new style screw-in type main differential lock carriers. MD-20-143, MP-20-143, RD-17-144, RD-19-144, RD-20-145, RD-22-145, RP-17-144, RP-19-144, RP-20-145, RP-22-145, RR-17-144, RR-19-144, RR-20-145, RS-17-144, RS-19-144, RS-21-145
2	2244-Z-1222	1	Push Rod	
3	2258-N-1262	1	Spring	
4	5-X-521	1	O-Ring	
5	41-X-1368	1	Caging Bolt	

## KIT 2751

ITEM	PART NUMBER	QTY.	DESCRIPTION	REMARKS
1	A2-3200-D-1980	1	Differential Carrier and Cap Assembly	Carrier and cap update kit (less diff. lock, less pump, with thrust screw) MD-20-143, RD-17-145, RD-20-140, RD-20-145, RD-22-145
2	41-X-1371	1	Thrust Screw	
3	40-X-1016	1	Jam Nut	

## KIT 2752

ITEM	PART NUMBER	QTY.	DESCRIPTION	REMARKS
1	A2-3200-F-1982	1	Differential Carrier and Cap Assembly	Carrier and cap update kit (with diff. lock, less pump, with thrust screw) RD-22-145
2	KIT 2691	1	Shift Cylinder Kit	
3	2206-L-1156	1	Elbow Fitting	
4	3296-Z-1170	1	Shift Fork, Finished	
5	2258-N-1262	1	Spring	

## KIT 2753

ITEM	PART NUMBER	QTY.	DESCRIPTION	REMARKS
1	A2-3200-J-1986	1	Differential Carrier and Cap Assembly	Carrier and cap update kit (less diff. lock, with pump, with thrust screw) RP-22-145
2	41-X-1371	1	Thrust Screw	
3	40-X-1016	1	Jam Nut	

## KIT 2754

ITEM	PART NUMBER	QTY.	DESCRIPTION	REMARKS
1	A2-3200-L-1988	1	Differential Carrier and Cap Assembly	Carrier and cap update kit (with diff. lock, with pump, with thrust screw) MP-20-143, RP-20-145, RP-22-145
2	KIT 2691	1	Shift Cylinder Kit	
3	2206-L-1156	1	Elbow Fitting	
4	3296-Z-1170	1	Shift Fork, Finished	
5	2258-N-1262	1	Spring	

## KIT 2755

ITEM	PART NUMBER	QTY.	DESCRIPTION	REMARKS
1	A2-3200-F-1904	1	Differential Carrier and Cap Assembly	Carrier and cap update kit (with diff. lock, with thrust screw) RR-20-145, RR-22-145, RS-21-145
2	KIT 2691	1	Shift Cylinder Kit	
3	2206-L-1156	1	Elbow Fitting	
4	3296-Z-1170	1	Shift Fork, Finished	
5	2258-N-1262	1	Spring	
6	40-X-1016	1	Jam Nut	
7	41-X-1371	1	Thrust Screw	

## KIT 2756

ITEM	PART NUMBER	QTY.	DESCRIPTION	REMARKS
1	A2-3200-A-1873	1	Differential Carrier and Cap Assembly	Carrier and cap update kit (with thrust screw) RR-17-145, RR-20-140, RR-20-145, RR-22-145, RS-16-141, RS-17-141, RS-19-145, RS-21-145
2	41-X-1371	1	Thrust Screw	
3	40-X-1016	1	Jam Nut	

## KIT 2758

ITEM	PART NUMBER	QTY.	DESCRIPTION	REMARKS
1	2234-V-1270	1	Differential Side Gear, Finished	Side gear and washer kit (2"-39 spline side gear) RD-17-145, RP-17-145, RR-17-145, RS-16-140, RS-16-141, RS-17-140, RS-17-141, RS-19-145
2	1229-V-4624	1	Thrust Washer	

# SERVICE KITS

## KIT 2759

ITEM	PART NUMBER	QTY.	DESCRIPTION	REMARKS
1	2234-U-1269	1	Differential Side Gear, Finished	Side gear and washer kit (2.1"-41 spline side gear) RD-20-140, RD-20-145, RP-20-145, RR-20-140, RR-20-145, RS-21-145
2	1229-V-4624	1	Thrust Washer	

## KIT 2760

ITEM	PART NUMBER	QTY.	DESCRIPTION	REMARKS
1	2234-X-1272	1	Differential Side Gear, Finished	Side gear and washer kit (2.1"-41 spline side gear) RD-22-145, RP-22-145, RR-22-145
2	1229-V-4624	1	Thrust Washer	

## KIT 2761

ITEM	PART NUMBER	QTY.	DESCRIPTION	REMARKS
1	1229-G-1021	1	Washer-Flat	RD-17-145, RP-17-145, RR-17-145, RS-16-140, RS-16-141, RS-17-140, RS-17-141, RS-17-145, RS-19-145
2	1229-J-4638	1	Washer-Lock	

## KIT 2819

ITEM	PART NUMBER	QTY.	DESCRIPTION	REMARKS
1	1229-D-4632	16	Washer-Hardened	Diff case capscrew kit. 145 Series
2	2297-F-6324	1	Loctite	
3	41-X-1327	16	Special Screw	

## KIT 2824

ITEM	PART NUMBER	QTY.	DESCRIPTION	REMARKS
1	2244-Z-1222	1	Push Rod	Main Differential Kit 140 Series
2	A-3261-A-1067	1	DCDL Shift Cylinder	

## KIT 2825

ITEM	PART NUMBER	QTY.	DESCRIPTION	REMARKS
1	2244-Y-1221	1	Push Rod	I.A.D. shift cylinder kit. 145 Series
2	A4-3261-Q-1057	1	IAD Shift Cylinder Assembly	

## KIT 2833

ITEM	PART NUMBER	QTY.	DESCRIPTION	REMARKS
1	A1-1205-X-2728	1	Oil Seal Assembly	Converts 145 series pump version 2"-39 input shaft to 2.35"-46 spline version. 145 Series
2	A1-3297-T-1346	1	Input Shaft Assembly	
3	A-3226-D-1226	1	Bearing Cage Assembly	
4	JM-511945	1	Bearing Cone	

## KIT 2834

ITEM	PART NUMBER	QTY.	DESCRIPTION	REMARKS
1	A1-1205-X-2728	1	Oil Seal Assembly	Converts 145 series less pump version 2"-39 input shaft to 2.35"-46 spline version. 145 Series
2	A-3226-V-1296	1	Bearing Cage Assembly	
3	A-3297-U-1347	1	Input Shaft Assembly	
4	JM-511945	1	Bearing Cone	

## KIT 2835

ITEM	PART NUMBER	QTY.	DESCRIPTION	REMARKS
1	A-3303-P-1030	1	Oil Pump Assembly	Pump update kit MP-20-143, RP-17-145, RP-20-145, RP-22-145
2	KIT 2833	1	Input Shaft Conv. Kit	

## KIT 4007

ITEM	PART NUMBER	QTY.	DESCRIPTION	REMARKS
1	1229-S-4985	1	Thrust Washer	Helical drive gear and thrust washer, replacing 3892-R-4932. 145 Series Forward
2	3892-S-5843	1	Forward IAD Gear	

# SERVICE KITS

## KIT 4284

ITEM	PART NUMBER	QTY.	DESCRIPTION	REMARKS
1	41-X-1637	2	Capscrew	Lock pin kit 145 Series
2	1199-R-2176	2	Cotter Pin	
3	1246-P-1134	1	Spirol Pin	

## KIT 4345

ITEM	PART NUMBER	QTY.	DESCRIPTION	REMARKS
1	JM-716610	1	Bearing Cup	RS-16-140, RS-17-140
2	1228-L-1130	1	Bearing Cup	
3	55200C	1	Bearing Cone	
4	M804049	1	Bearing Cone	
5	1228-F-552	1	Spigot Bearing	
6	JM-716649	1	Bearing Cone	
7	A-1228-L-1130	1	Bearing Cone	
8	55437	1	Bearing Cup	
9	M804010	1	Bearing Cup	
10	A-1205-D-1928	1	Seal Assy	

## KIT 4350

ITEM	PART NUMBER	QTY.	DESCRIPTION	REMARKS
1	M804010	1	Bearing Cup	RS-16-140, RS-17-140
2	M804049	1	Bearing Cone	
3	55437	1	Bearing Cup	
4	55200C	1	Bearing Cone	
5	1228-F-552	1	Spigot Bearing	
6	JM-716610	2	Bearing Cup	
7	JM-716649	2	Bearing Cone	
8	A-1205-D-1928	1	Seal Assy	

## KIT 4356

ITEM	PART NUMBER	QTY.	DESCRIPTION	REMARKS
1	H715311	1	Bearing Cup	New Style Thru-Shaft RD-20-140
2	72487	1	Bearing Cup	
3	JLM-710910	1	Bearing Cup	
4	H715334	1	Bearing Cone	
5	72212C	1	Bearing Cone	
6	LM-603011	2	Bearing Cup	
7	JM-716610	2	Bearing Cup	
8	JLM-710949C	1	Bearing Cone	
9	3920	1	Bearing Cup	
10	A1-1205-X-2728	1	Oil Seal Assembly	
11	A-1205-G-2425	1	Seal Assembly	
12	5-X-1034	1	O-Ring	
13	JM-511945	1	Bearing Cone	
14	LM-603049	2	Bearing Cone	
15	JM-716649	2	Bearing Cone	
16	5-X-1343	1	O-Ring	

## KIT 4385

ITEM	PART NUMBER	QTY.	DESCRIPTION	REMARKS
1	72212C	1	Bearing Cone	RR-20-145, RR-22-145, RS-21-145
2	55206C	1	Bearing Cone	
3	A1-1228-H-606	2	Tapered Bearing Assembly	
4	72487	1	Bearing Cup	
5	55437	1	Bearing Cup	
6	1228-F-552	1	Spigot Bearing	
7	A1-1205-Z-2730	1	Oil Seal Assembly	



# SERVICE KITS

## KIT 4390

ITEM	PART NUMBER	QTY.	DESCRIPTION	REMARKS
1	JM-716649	1	Bearing Cone	RR-17-144, RR-19-144, RR-20-145, RR-22-145, RS-17-144, RS-19-144, RS-21-145
2	A-1228-L-1130	1	Bearing Cone	
3	JM-716610	1	Bearing Cup	
4	1228-L-1130	1	Bearing Cup	
5	72487	1	Bearing Cup	
6	55437	1	Bearing Cup	
7	72212C	1	Bearing Cone	
8	55206C	1	Bearing Cone	
9	1228-F-552	1	Spigot Bearing	
10	A1-1205-Z-2730	1	Oil Seal Assembly	

## KIT 4395

ITEM	PART NUMBER	QTY.	DESCRIPTION	REMARKS
1	H715311	1	Bearing Cup	Pre 11/93 RD-17-145, RD-20-145, RD-22-145, RP-17-145, RP-20-145, RP-22-145
2	72487	1	Bearing Cup	
3	JLM-710910	1	Bearing Cup	
4	H715334	1	Bearing Cone	
5	72212C	1	Bearing Cone	
6	JLM-104910	2	Bearing Cup	
7	JM-716610	2	Bearing Cup	
8	JLM-710949C	1	Bearing Cone	
9	JM511910	1	Bearing Cup	
10	R945008	2	Oil Seal Assembly	
11	5-X-1034	1	O-Ring	
12	5-X-1343	1	O-Ring	
13	JM-511946	1	Bearing Cone	
14	3920	1	Bearing Cup	
15	LM-104949	2	Bearing Cone	
16	JM-716649	2	Bearing Cone	

## KIT 4396

ITEM	PART NUMBER	QTY.	DESCRIPTION	REMARKS
1	H715311	1	Bearing Cup	Forward Axles less diff. lock, with new input and thru shaft MD-20-143, MP-20-143, RD-17-144, RD-17-145, RD-19-144, RD-20-145, RD-22-145, RP-17-144, RP-17-145, RP-19-144, RP-20-145, RP-22-145
2	72487	1	Bearing Cup	
3	JLM-710910	1	Bearing Cup	
4	H715334	1	Bearing Cone	
5	72212C	1	Bearing Cone	
6	JLM-104910	2	Bearing Cup	
7	JM-716610	2	Bearing Cup	
8	JLM-710949C	1	Bearing Cone	
9	3920	1	Bearing Cup	
10	A1-1205-Y-2729	1	Oil Seal Assembly	
11	A1-1205-X-2728	1	Oil Seal Assembly	
12	5-X-1034	1	O-Ring	
13	5-X-1343	1	O-Ring	
14	JM-511945	1	Bearing Cone	
15	LM-104949	1	Bearing Cone	
16	JM-716649	1	Bearing Cone	

## KIT 4400

ITEM	PART NUMBER	QTY.	DESCRIPTION	REMARKS
1	72487	1	Bearing Cup	RR-17-144, RR-17-145, RR-19-144, RR-20-140, RR-20-145, RR-22-145, RS-16-141, RS-17-141, RS-17-144, RS-19-144, RS-19-145, RS-21-145
2	72212C	1	Bearing Cone	
3	55437	1	Bearing Cup	
4	55206C	1	Bearing Cone	
5	1228-F-552	1	Spigot Bearing	
6	JM-716610	2	Bearing Cup	
7	JM-716649	2	Bearing Cone	
8	A1-1205-Z-2730	1	Oil Seal Assembly	

# SERVICE KITS

## KIT 4406

ITEM	PART NUMBER	QTY.	DESCRIPTION	REMARKS
1	72487	1	Bearing Cup	Forward Axles with diff. lock, with new input and thru shaft MD-20-143, MP-20-143, RD-17-144, RD-19-144, RD-20-145, RD-22-145, RP-17-144, RP-19-144, RP-20-145, RP-22-145
2	72212C	1	Bearing Cone	
3	H715311	1	Bearing Cup	
4	H715334	1	Bearing Cone	
5	3920	1	Bearing Cup	
6	JM-511945	1	Bearing Cone	
7	JLM-710910	1	Bearing Cup	
8	JLM-710949C	1	Bearing Cone	
9	1228-L-1130	1	Bearing Cup	
10	A-1228-L-1130	1	Bearing Cone	
11	JM-716610	1	Bearing Cup	
12	JM-716649	1	Bearing Cone	
13	JLM-104910	1	Bearing Cup	
14	LM-104949	1	Bearing Cone	
15	A1-1205-Y-2729	1	Oil Seal Assembly	
16	A1-1205-X-2728	1	Oil Seal Assembly	
17	5-X-1034	1	O-Ring	
18	5-X-1343	1	O-Ring	

## KIT 4455

ITEM	PART NUMBER	QTY.	DESCRIPTION	REMARKS
1	3237-W-1167	1	Switch Assembly Sensor	With diff. lock 140 Series
2	2257-M-1235	1	Sensor/Switch Clip	

## KIT 4461

ITEM	PART NUMBER	QTY.	DESCRIPTION	REMARKS
1	72487	1	Bearing Cup	For Amboid drive axle. MR-20-143
2	72225C	1	Bearing Cone	
3	H715311	1	Bearing Cup	
4	H715334	1	Bearing Cone	
5	JM-716610	2	Bearing Cup	
6	JM-716649	2	Bearing Cone	
7	A1-1205-Z-2730	1	Oil Seal Assembly	

## KIT 4766

ITEM	PART NUMBER	QTY.	DESCRIPTION	REMARKS
1	10-X-1710	1	Thrust Screw	Thrust screw and block kit for 3200-W-2051 amboid carrier. MR-20-143M, MS-21-143M
2	2297-P-8336	1	Thrust Block	

## MPS 3344 145

ITEM	PART NUMBER	QTY.	DESCRIPTION	REMARKS
1	A-3297-U-1347	1	Input Shaft Assembly	Input shaft/IAD update kit for 2.38"-46 spline, less pump version. 145 Series
2	1229-S-4985	1	Thrust Washer	
3	3892-S-5843	1	Forward IAD Gear	
4	A-3235-W-2025	1	Interaxle Differential Case & Nest Assembly	
5	2297-E-5335	1	Snap Ring	
6	2234-R-1188	1	Differential Side Gear, Finished	
7	A1-1205-X-2728	1	Oil Seal Assembly	
8	2203-K-9241	1	Shim - .076mm/.003 in.	
9	2203-L-9242	1	Shim - .127mm/.005 in.	
10	2203-M-9243	1	Shim - .254mm/.010 in.	

# SERVICE KITS

## MPS 3345 145

ITEM	PART NUMBER	QTY.	DESCRIPTION	REMARKS
1	A1-3297-T-1346	1	Input Shaft Assembly	Input shaft/IAD update kit for 2.38"-46 spline, for pump version. 145 Series
2	1229-S-4985	1	Thrust Washer	
3	3892-S-5843	1	Forward IAD Gear	
4	A-3235-W-2025	1	Interaxle Differential Case & Nest Assembly	
5	2297-E-5335	1	Snap Ring	
6	2234-R-1188	1	Differential Side Gear, Finished	
7	A1-1205-X-2728	1	Oil Seal Assembly	
8	2203-K-9241	1	Shim - .076mm/.003 in.	
9	2203-L-9242	1	Shim - .127mm/.005 in.	
10	2203-M-9243	1	Shim - .254mm/.010 in.	



## NUMERICAL PARTS LISTING

PART NUMBER	PAGE	PART NUMBER	PAGE	PART NUMBER	PAGE
5-X-521	8,18	1229-W-1245	5	1244-S-2437	11
5-X-1034	4	1229-A-1301	13	1244-T-2438	11
5-X-1153	8,18	1229-U-1503	8,14	1244-U-2439	11
5-X-1195	5	1229-C-1511	4,11	1244-W-2441	11
5-X-1196	5	1229-W-1557	21	1244-X-2442	11
5-X-1197	5	1229-K-1597	4,6	1244-Y-2443	11
5-X-1198	8,18	1229-T-1606	4	1244-Z-2444	11
10-X-1594	21	1229-E-1669	4,9,21	1244-A-2445	11
10-X-1597	21	1229-N-1730	4	1244-B-2446	11
10-X-1710	13	1229-T-1736	4,11,20	1244-C-2447	11
15-X-387	20	1229-A-2237	20	1246-M-1131	9
40-X-1016	6,13	1229-B-2238	20	1246-P-1134	8
40-X-1145	6	1229-C-2239	20	1250-E-473	21
40-X-1182	8,14	1229-D-2240	20	1250-N-1080	9
40-X-1233	4,6	1229-E-2241	20	1250-U-1217	8
40-X-1236	11,20	1229-F-2242	20	1250-L-1286	21
40-X-1237	4,11,20	1229-G-2243	20	2203-F-2788	6,11
41-X-1022	8,19	1229-H-2244	20	2203-G-2789	6,11
41-X-1043	11	1229-J-2246	20	2203-H-2790	6,11
41-X-1080	5,18	1229-K-2247	20	2203-C-8115	11
41-X-1208	4	1229-P-2590	20	2203-D-8116	11
41-X-1209	5	1229-Q-2591	20	2203-E-8117	11
41-X-1216	8,14	1229-R-2592	20	2203-K-9241	4
41-X-1327	7,18	1229-T-2594	20	2203-L-9242	4
41-X-1330	18	1229-U-2595	20	2203-M-9243	4
41-X-1333	8,18	1229-V-2596	20	2203-J-9474	11
41-X-1359	19	1229-W-2597	20	2203-K-9475	11
41-X-1364	9,19	1229-X-2598	20	2203-L-9476	11
41-X-1365	8,13	1229-Y-2599	20	2203-M-9477	11
41-X-1368	8,18	1229-A-2653	11,20	2203-N-9478	11
41-X-1371	6,13	1229-S-2593	20	2203-P-9480	11
42-X-1021	8,13	1229-Z-3172	17	2203-Q-9481	11
42-X-1248	9,19	1229-F-4062	9	2203-R-9482	11
43-X-1006	8,18	1229-G-4063	6	2203-S-9483	11
43-X-1007	9,18	1229-W-4131	20	2203-T-9484	11
1199-R-2176	8,13	1229-P-4280	4	2203-U-9485	11
A-1205-W-1349	21	1229-B-4422	9,19	2203-V-9486	12
A-1205-D-1928	11	1229-H-4428	9,19	2203-W-9487	12
A-1205-G-2425	20	1229-U-4519	9,19	2203-X-9488	12
A-1205-Q-2487	21	1229-W-4521	6	2203-Y-9489	12
1220-K-89	18	1229-X-4522	8,17	2203-Z-9490	12
1227-R-330	21	1229-V-4624	8,17	2203-A-9491	12
1227-W-517	21	1229-D-4632	7,18	2203-B-9492	12
1227-Z-1040	21	1229-F-4634S	21	2203-C-9493	12
1227-E-1045	21	1244-V-1764	6	2203-D-9494	12
1227-P-1056	8,19	1244-F-2346	12	2203-E-9495	12
1228-F-552	13	1244-V-2440	11	2203-F-9496	12
A1-1228-H-606	14	1244-M-2431	11	2203-B-9804	11
1228-L-1130	6,14	1244-N-2432	11	2203-D-9806	6
A-1228-L-1130	7,14	1244-P-2434	11	2203-E-9807	6
1229-L-1026	18	1244-Q-2435	11	2203-F-9808	6
1229-R-1032	8,18	1244-R-2436	11	2203-G-9809	6

## NUMERICAL PARTS LISTING

PART NUMBER	PAGE	PART NUMBER	PAGE	PART NUMBER	PAGE
2203-H-9810	6	2803-R-2852	11	3202-S-9483	26
2203-J-9812	6	2803-S-2853	11	3202-T-9484	26
2203-K-9813	6	2803-T-2854	11	3202-U-9485	26
2203-L-9814	6	3107-R-1006	18	3202-X-9488	26
2203-M-9815	6	3107-D-1018	9,18	3202-C-9597	26
2203-N-9816	6	3107-M-1183	4	3202-E-9599	26
2203-P-9818	6	3196-F-32	8,18	3202-G-9601	26
2203-Q-9819	6	A2-3200-R-1500	13	3202-J-9604	26
2203-R-9820	6	A2-3200-G-1645	5	3202-N-9608	26
2203-S-9821	6	A2-3200-X-1662	5	3202-Q-9611	26
2203-T-9822	6	A2-3200-L-1676	13	3202-S-9613	26
2203-U-9823	6	A2-3200-G-1853	5	3202-U-9615	26
2208-P-536	21	A2-3200-C-1849	13	3202-W-9617	26
2208-H-944	8,18	A2-3200-D-1850	13	3202-Y-9619	26
2208-L-1000	9,19	A2-3200-E-1851	13	3202-R-9638	26
2208-R-1058	5	A2-3200-F-1852	5	3202-Q-9845	26
2214-L-272	13	A2-3200-S-1865	13	3202-S-9847	26
2214-Y-1039	6,13	A2-3200-A-1873	13	3206-Q-1343	26
2214-C-1095	6,13	A2-3200-G-1879	13	3206-S-1345	26
2214-U-1139	13	A2-3200-M-1885	13	3206-T-1346	26
2230-N-170	8,18	A2-3200-D-1902	5	3206-U-1347	26
2230-D-1096	5	A2-3200-E-1903	5	3206-W-1349	26
2230-T-1190	8,18	A2-3200-F-1904	13	3206-Y-1351	26
2233-J-1024	8,18	A2-3200-P-1914	5	3206-Z-1352	26
2233-M-1027	18	A2-3200-S-1917	5	3206-A-1353	26
2233-U-1035	4	A2-3200-Z-1924	13	3206-C-1563	26
2233-X-1116	8,18	A2-3200-B-1978	5	3206-C-1823	26
2234-T-1086	17	A2-3200-C-1979	5	3206-D-1824	26
2234-R-1188	4	A2-3200-D-1980	5	3206-M-1885	26
2234-U-1269	8,17	A2-3200-E-1981	5	3206-P-1888	26
2234-V-1270	8,17	A2-3200-F-1982	5	3216-Q-4359	9,19
2234-X-1272	8,17	A2-3200-H-1984	5	3216-S-4361	9,19
2244-Z-52	18	A2-3200-J-1986	5	3221-P-1004	4
2244-K-1025	4	A2-3200-K-1987	5	A-3226-M-1053	11
2244-L-1026	8,18	A2-3200-L-1988	5	A-3226-P-1056	11
2244-D-1070	4	A2-3200-W-2051	13	A-3226-T-1112	20
2257-M-1235	8,19	3202-S-9041	26	A-3226-Z-1222	4
2258-U-411	4	3202-T-9042	26	A-3226-B-1224	4
2258-L-714	8,18	3202-U-9043	26	A-3226-D-1226	4
2258-Z-1118	9	3202-X-9046	26	A-3226-N-1236	11
2258-E-1175	4	3202-Y-9047	26	A-3226-V-1296	4
2258-U-1243	9,19	3202-B-9050	26	A-3230-T-1034	8,18
2258-N-1262	8,18	3202-C-9051	26	A-3230-U-1035	8,18
2297-T-4180	14	3202-Q-9117	26	A-3230-V-1036	18
2297-U-5273	9	3202-R-9118	26	A4-3235-C-1719	16
2297-Z-5278	9	3202-S-9119	26	A6-3235-C-1719	14
A-2297-D-5334	9	3202-Y-9281	26	A12-3235-C-1719	16
2297-E-5335	4	3202-F-9340	26	A13-3235-C-1719	14
2297-A-7021	20,21	3202-G-9341	26	A6-3235-E-1721	16
2297-C-7049	18	3202-H-9342	26	A8-3235-E-1721	14
2297-P-8336	13	3202-W-9461	26	A14-3235-E-1721	16
2803-Q-2851	11	3202-Y-9463	26	A15-3235-E-1721	14

# NUMERICAL PARTS LISTING

PART NUMBER	PAGE	PART NUMBER	PAGE	PART NUMBER	PAGE
A2-3235-Y-1741	14	A3-3235-L-2170	7,14	55200C	12
A3-3235-Y-1741	16	A4-3235-L-2170	7,17	55206C	11
A-3235-S-1839	14	A5-3235-L-2170	7,17	55437	11,12
A1-3235-S-1839	15	A2-3235-M-2171	7,14	72212C	6,12
A2-3235-S-1839	7,14	A3-3235-M-2171	7,14	72225C	11
A3-3235-S-1839	7,15	A4-3235-M-2171	7,17	72487	6,11,12
A8-3235-S-1839	7,14	A5-3235-M-2171	7,17	141DYS28A	29
A9-3235-S-1839	7,15	A2-3235-N-2172	14	148DYS28A	29
A10-3235-S-1839	7	A3-3235-N-2172	14	148TYS32-4A	29
A11-3235-S-1839	7,17	A6-3235-N-2172	17	155DYS28-1A	29
A12-3235-S-1839	7,17	A7-3235-N-2172	17	155DYS32-6	29
A-3235-U-1841	14	A-3235-D-2188	14	155DYS32-6A	29
A1-3235-U-1841	16	A2-3235-D-2188	14	155NYS28-5A	29
A2-3235-U-1841	7,14	A4-3235-D-2188	7,17	155TYS32-2A	29
A3-3235-U-1841	7,15	A10-3235-D-2188	7	155TYS32-6A	29
A8-3235-U-1841	7,14	A11-3235-D-2188	7,15	16N-4-5621X	27
A9-3235-U-1841	7,15	A2-3235-Y-2261	17	16N-4-6251	27
A10-3235-U-1841	7	A-3235-N-2380	4	16N-4-6261	27
A11-3235-U-1841	7,17	A2-3235-N-2380	4	16N-4-6271-1	29
A12-3235-U-1841	7,16	3237-W-1167	8,19	16N-4-6281X	27
A-3235-W-1843	14	A-3261-L-350	4	16N-4-6291X	27
A1-3235-W-1843	16	3261-A-1067	8,18	16N-4-6431-1X	29
A2-3235-W-1843	7,14	3261-R-1084	5	16N-4-7341-1X	29
A3-3235-W-1843	7,15	3266-M-897	18	16NYS38-8A	27
A8-3235-W-1843	7,14	3266-C-1095	6	16TYS28-13A	29
A9-3235-W-1843	7,15	3266-F-1020	8,18	16TYS32-32A	29
A10-3235-W-1843	7,15	3266-Q-1161	5	16TYS32-76	29
A11-3235-W-1843	7,16	3278-D-82	18	16TYS32-76A	29
A12-3235-W-1843	7,16	3278-S-305	8,18	16TYS32-86A	29
A2-3235-V-1920	7,14	3278-Y-1117F	8,18	170TYS32-2	29
A3-3235-V-1920	7,15	3278-A-1119	4	170TYS32-2A	29
A8-3235-V-1920	7,14	3280-V-8394	9	170TYS38-4A	29
A9-3235-V-1920	7,15	3280-Z-8398	9	176N-4-531	27
A10-3235-V-1920	7	SA1-3280-U-8861	9,19	176N-4-541-1X	29
A11-3235-V-1920	7,17	3296-F-188	18	176N-4-541X	27
A12-3235-V-1920	7,17	3296-W-1167	9,18	176NYS32-3A2	27
A18-3235-V-1920	16	3296-Z-1170	9,18	176NYS38-14A	27
A-3235-N-1938	14	3297-E-1019	20	176TYS32-3A1	29
A1-3235-N-1938	16	3297-N-1158	20	176TYS38-27A	29
A-3235-Q-1941	14	A-3297-T-1346	4	17N-4-6321	27
A1-3235-Q-1941	16	A-3297-U-1347	4	17N-4-6331	27
A-3235-W-2025	4	A-3303-P-1030	9	17N-4-6391X	27
A4-3235-T-2152	8,17	3892-N-4902	6	17N-4-6411X	27
A10-3235-T-2152	7	572	21	17N-4-7181X	27
A11-3235-T-2152	7,15	580	21	17N-4-7631-1X	29
A2-3235-J-2168	7,15	592A	21	17N-4-7641-1X	29
A3-3235-J-2168	7,15	594A	21	17NYS28-43A	27
A4-3235-J-2168	7,17	3920	4	17NYS32-100	27
A5-3235-J-2168	7,17	39520	21	17NYS32-100A	27
A1-3235-K-2169	15	39590	21	17NYS32-99	27
A2-3235-K-2169	17	47620	21	17NYS32-99A	27
A2-3235-L-2170	7,14	47686	21	17TYS28-57A	29

## NUMERICAL PARTS LISTING

PART NUMBER	PAGE	PART NUMBER	PAGE	PART NUMBER	PAGE
KIT 2321	40	KIT 2834	47		
KIT 2322	40	KIT 2835	47		
KIT 2389	41	KIT 4007	47		
KIT 2396	41	KIT 4284	48		
KIT 2405	41	KIT 4345	48		
KIT 2413	41	KIT 4350	48		
KIT 2420	42	KIT 4356	48		
KIT 2429	42	KIT 4385	48		
KIT 2431	42	KIT 4390	49		
KIT 2445	42	KIT 4395	49		
KIT 2446	42	KIT 4396	49		
KIT 2482	43	KIT 4400	49		
KIT 2488	43	KIT 4406	50		
KIT 2511	43	KIT 4455	50		
KIT 2512	43	KIT 4461	50		
KIT 2522	43	KIT 4766	50		
KIT 2541	43	KIT RD20140NL	38		
KIT 2636	43	KIT RD20145DL	38		
KIT 2637	43	KIT RD20145NL	38		
KIT 2638	43	KIT RR22145 1873	38		
KIT 2647	44	KIT RS145 1500	38		
KIT 2648	44	KIT RS145 1547	38		
KIT 2662	44	KIT RS145 1676	39		
KIT 2664	44	KIT RS17140	39		
KIT 2665	44	LM-104949	20		
KIT 2668	44	LM-603011	20		
KIT 2686	44	LM-603049	20		
KIT 2691	44	M804010	11		
KIT 2696	45	M804049	11		
KIT 2703	45	MN-312-1	4		
KIT 2704	45	MPS 3344 145	50		
KIT 2705	45	MPS 3345 145	51		
KIT 2706	45	MS-206060-1	5		
KIT 2709	45	MS-208016-1	4		
KIT 2730	45	MS-208020-1	18		
KIT 2743	45	MS-208045-1	9		
KIT 2747	45	MS-210016-1	8,19		
KIT 2750	46	MS-210020-1	6		
KIT 2751	46	MS-210030-1	6		
KIT 2752	46	MS210045A-1	4		
KIT 2753	46	MS-212045-1	4,11		
KIT 2754	46	MS-220120-1	8,13		
KIT 2755	46	MWA-506	5,9		
KIT 2756	46	MWA-508	19		
KIT 2758	46	N-110-1	21		
KIT 2759	47	P-28-S	21		
KIT 2760	47	P-212	21		
KIT 2761	47	RV-71016	8,14		
KIT 2819	47	S-258-2	21		
KIT 2824	47	S-21016-2	21		
KIT 2825	47	S-21020A-2	21		
KIT 2833	47				



## MERITOR AFTERMARKET PARTS WARRANTY

We warrant all new parts for one year from date of shipment to the buyer against defective material or workmanship (but not against damage caused by accident, abuse or improper installation, maintenance or repair) when such parts are used on vehicles the specifications of which have been approved by our Engineering Department.

As the exclusive remedy under this warranty, we will, at our option, repair or replace such parts free of charge, or take back the nonconforming parts and refund the monies paid by buyer for such parts, if found on examination by us to be nonconforming and if any necessary return charges are prepaid.

If it is necessary to return any parts under this warranty, buyer agrees not to make any deduction on account thereof from remittances on current accounts while claims are in the process of disposition. Any expense incurred without our consent for repairs or replacement will not be allowed.

THIS WARRANTY IS EXPRESSLY IN LIEU OF ALL OTHER WARRANTIES OR CONDITIONS, EXPRESS, IMPLIED OR STATUTORY, INCLUDING ANY IMPLIED WARRANTY OF MERCHANTABILITY OR FITNESS FOR PARTICULAR PURPOSE. IN NO EVENT SHALL SELLER BE LIABLE FOR INCIDENTAL OR CONSEQUENTIAL DAMAGES OF ANY NATURE.

Only genuine Meritor replacement parts are covered by this aftermarket parts warranty.

Vehicle models, brands and names depicted herein are the property of their respective owners, and are not in any way associated with Meritor, Inc., or its affiliates.



Meritor Heavy Vehicle Systems, LLC  
7975 Dixie Highway  
Florence, Kentucky 41042 USA

888-725-9355 U.S.  
800-387-3889 Canada  
MeritorPartsOnline.com  
meritor.com

©2012 Meritor, Inc.  
Litho in USA, PB-9147  
Revised 12-12 (47865/11900)



**MERITOR**

## **Meritor Axle Model RT-40-145 - RR-20-145 - Carrier B1-3200-E-1851**

Pro Gear parts and service manual for Meritor Axle Model RT-40-145 - RR-20-145 - Carrier B13200E1851 to assist you in identifying the correct configuration of your Meritor Axle. This Meritor B13200E1851 axle, is available and ready for international shipping. Call today!

If you need any assistance identifying the correct Meritor axle unit for your truck or equipment, contact your Meritor axle replacement specialists at Pro Gear and Transmission.

Pro Gear stocks every part for your Meritor axle RT40145 and RR20145. We have 1000's of products in shop that are ready to ship internationally for your next project.

For parts or service contact the Meritor specialists at Pro Gear & Transmission, Inc.

 CALL US

 EMAIL US

 VISIT MODEL PAGE

 VISIT ONLINE STORE