

Meritor Axle Model RT-40160 - RD-23160 - Carrier A-3200-J-2116

Pro Gear parts and service manual for Meritor Axle Model RT-40160 - RD-23160 - Carrier A3200J2116 to assist you in identifying the correct configuration of your Meritor Axle. This Meritor A3200J2116 axle, is available and ready for international shipping. Call today!

If you need any assistance identifying the correct Meritor axle unit for your truck or equipment, contact your Meritor axle replacement specialists at Pro Gear and Transmission.

Pro Gear stocks every part for your Meritor axle RT40160 and RD23160. We have 1000's of products in shop that are ready to ship internationally for your next project.

For parts or service contact the Meritor specialists at Pro Gear & Transmission, Inc.

 CALL US

 EMAIL US

 VISIT MODEL PAGE

 VISIT ONLINE STORE



MERITOR[®]

An **ArvinMeritor**[™] Brand

**160, 161 AND 164 SERIES
DRIVE AXLE PARTS**

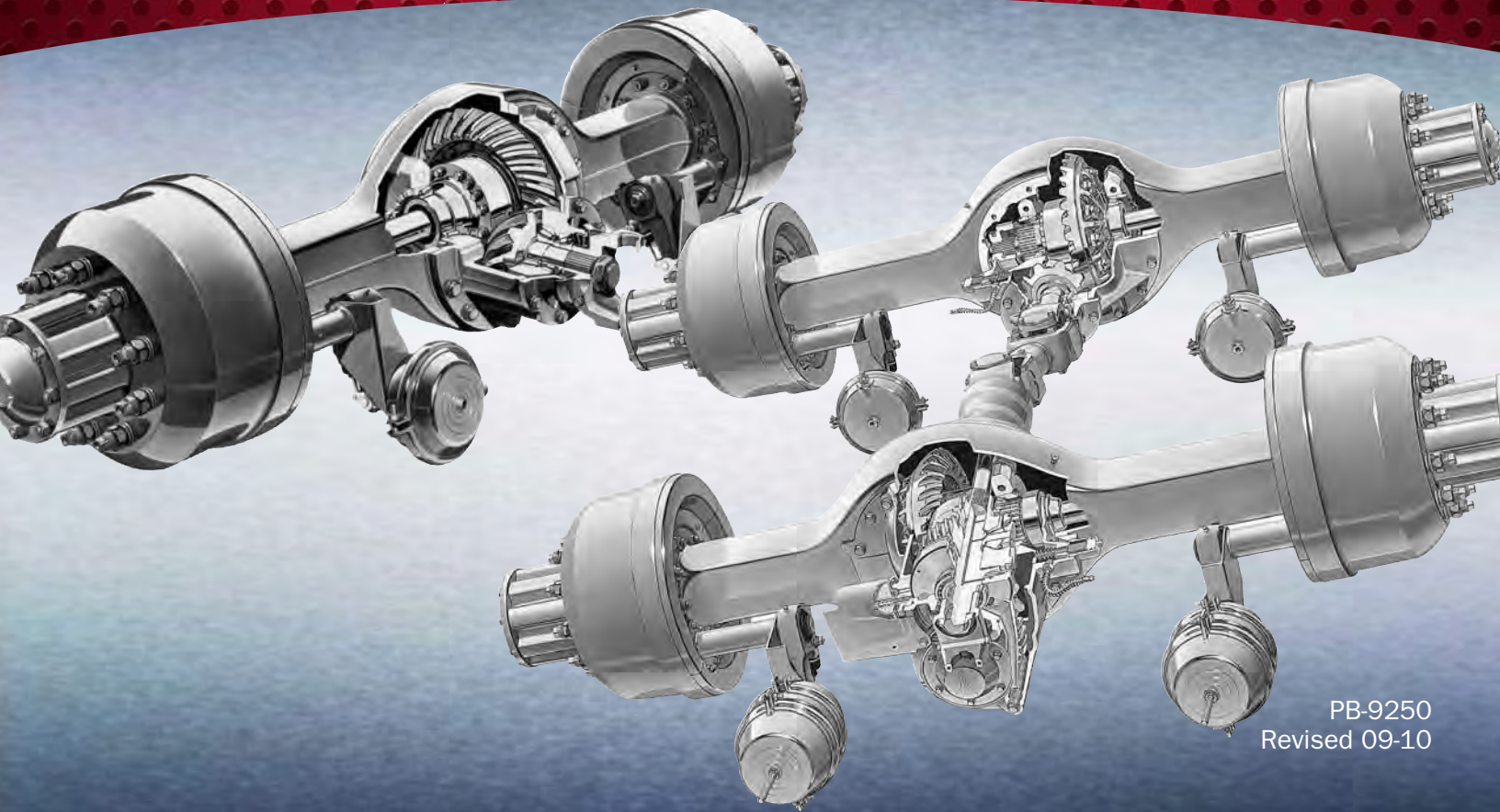

PB-9250
Revised 09-10

FIGURE 2 CARRIERS FOR SINGLE AXLES AND REAR OF TANDEM AXLES (USE WITH CHART 2)



• Circled \bigcirc numbers are diff. lock parts or parts that change when diff. lock is added.

SUPPLEMENTAL DRAWING CARRIERS WITH INTERNAL A.B.S.



• Circled  numbers are Forward Axle Assembly parts.

REAR DRIVE AXLES

Model Numbers and Designations

Axle models are identified by a letter and number system.

The letters and numbers give important information about the specific axle model.

The first seven positions of the designation identify a basic axle model, while the second group of letters and numbers identify particular specifications.



NOTE 1:

If a complete axle designation is not required, use the first seven positions of the model designation to identify the basic axle model.

EXAMPLES OF BASIC AXLE MODELS:

RS 17 140 - Single Rear Drive, 17,000 lb., Single Speed, 15" Ring Gear, 140 Carrier Model.

RT 48 380 - Tandem Drive Axle Set, 48,000 lb., Helical Double Reduction, 19.62" Ring Gear, 380 Carrier Model.

RZ 60 164 - Tridem Drive Axle Set, 60,000 lb., Single Speed, Includes a 150 Series Forward Rear or First Axle and a 145 Series Tandem Axle Set as the Second and Third Axles.

NOTE 2, FOR TRIDEM AXLES ONLY:

For a Tridem Drive Axle Set (**RZ**), the number in the sixth position designates the carrier in the first axle. The number in the seventh position designates the carriers in the second and third axles.

NOTE 3:

Some axle designations or specifications do not have a hub type code.

HOW TO USE THIS CATALOG

- There are 36 basic carriers covered in this catalog:

3200-C-1511	3200-P-1706	3200-C-1823	3200-V-1894	3200-K-2117
3200-Z-1560	3200-R-1708	3200-E-1825	3200-W-1895	3200-L-2118
3200-P-1628	3200-V-1712	3200-Q-1837	3200-Y-1897	3200-J-2137
3200-J-1648	3200-W-1713	3200-H-1854	3200-J-1908	3200-K-2138
3200-T-1658	3200-X-1818	3200-J-1856	3200-K-1909	
3200-V-1660	3200-Y-1819	3200-K-1857	3200-D-1928	
3200-K-1701	3200-Z-1820	3200-L-1858	3200-E-1929	
3200-M-1703	3200-A-1821	3200-T-1892	3200-J-2116	

Major assembly differences in a carrier are indicated by the different assembly level numbers in front of the base carrier number, for example, A1-3200-V-1894 and A4-3200-V-1894. The Axle Models-Carriers-Features chart inside this front cover lists all the variations covered in this book.

Note: The carriers listed in this catalog do not include yokes. A yoke is a major assembly difference, therefore, a carrier sold with a yoke has a different assembly level number than the same carrier without the yoke.

- The charts for carriers, output shafts, and housings include the following information:

- An exploded view of each assembly, keyed to the parts list
- A description of each part
- Parts sold as assemblies that include other parts
- Which carriers or axle models the part is used on
- The quantity of the part used on the carrier or axle
- The part number of each item
- Whether the part is available in a kit

- **Carrier parts:**

Determine which chart and figure (1 or 2) applies to your carrier by using the following sources of information.

- Identification tag installed on the carrier
- Axle Models-Carriers-Features Chart
- Pictures and descriptions of the carriers inside the front cover and at the beginning of Chart 1 and Chart 2

- **Output (thru) shafts:**

This chart covers the output shafts for the forward axles of all tandems. Note that the output shaft assembly or its components are only sold as separate items. The output shaft is not included with the purchase of a carrier or housing.

- **Housing Assemblies and Wheel End Parts:**

This chart covers the housing assemblies and wheel end parts for all axles. The parts are listed according to axle models that are used on 160, 161 and 164 series axles.

- **Axle shafts:**

The axle shafts are grouped in sets (L.H. and R.H.) according to the axle models they are used on. Many axle shafts are used on more than one axle model. The axle shafts are also listed by part number with dimensions.

- **Yokes and Flanges:**

There are four charts that cover full round bearing yokes, wing bearing yokes, Easy Service yokes, and flanges. Each chart lists the yokes or flanges used on each model. The yokes and flanges are listed by dimensions.

- **Kits:**

The first chart in this section lists all the kits available for each axle model and carrier. Following that chart, the kits are sequenced according to the kit number and list the contents of each kit.

- **Numerical Parts List:**

This section lists every part number along with the page(s) on which the part is listed.

AXLE MODELS - CARRIERS - FEATURES

160, 161 & 164

Single Reduction Axles (Single & Tandem)

AXLE MODELS (All models shown below are 2.38"-46 axle spline)		CARRIERS	INTER-AXLE DIFF.	MAIN DIFF. LOCK	NO- SPIN® DIFF.	OIL PUMP	CARRIER PARTS CHART NO.	
RS-21160/161	Single Axle	A1-3200-P-1706					2	
RS-23160/161		A-3200-E-2137 (1)					2	
RS-24160/161		A-3200-F-2138 (1)		●	●		2	
RS-25160/161								
RS-26160/161								
RT-40160	Forward	RD-20160	A6-3200-Q-1837 (2)	●			1	
RT-46160		RD-23160	A-3200-J-2116 (1)	●			1	
RT-46164		RD-23164	A1-3200-J-1908 (2)	●	●		1	
RT-50160		RD-25160	A3-3200-L-2118 (1)	●	●		1	
RT-50164		RD-26160	A1-3200-J-2116 (1)	●		●	1	
RT-52160		RP-20160	A1-3200-K-1909 (2)	●		●	1	
RT-52164		RP-23160	A-3200-K-2117 (1)	●		●	1	
		RP-23164	A5-3200-K-1909 (2)	●	●	●	1	
		RP-25160	A3-3200-K-2117 (1)	●	●	●	1	
		RP-26160	A1-3200-K-2117 (1)	●		●	●	1
		RP-29160						
		Rear	RR-20160	A1-3200-P-1706				2
			RR-23160	A-3200-E-2137 (1)				2
			RR-23164	A1-3200-A-1821 (2)				2
	RR-25160		A1-3200-T-1892		●		2	
	RR-26160		A-3200-F-2138 (1)		●		2	
	RR-29160		A1-3200-D-1928 (2)		●		2	
			A17-3200-P-1706			●		2

REMAN AXLE MODEL OFFERING

REMAN AXLE DESIGNATION	OEM PRODUCTION DESIGNATION	COMMENTS
RD23160/164	RT46/50/52160 Forward RT46/50/52164 Forward	
RP23160/164	RT46/50/52160 Forward RT46/50/52164 Forward	With pump
RDL23160/164	RT46/50/52160 Forward RT46/50/52164 Forward	With main diff. lock
RPL23160/164	RT46/50/52160 Forward RT46/50/52164 Forward	With pump and main diff. lock
RR23160/164	RT46/50/52160 Rear RT46/50/52164 Rear	Can be used as a single axle replacement for RS23160
RRL23160/164	RT46/50/52160 Rear RT46/50/52164 Rear	With main diff. lock, can be used as a single axle replacement for RS23160 with main diff. lock

(1) Tapered dowel

(2) With thrust screw

STANDARD CARRIER SUPERCESSION LIST

ORIGINAL PART NUMBER	REPLACEMENT PART NUMBER
A15-3200-C-1511	A1-3200-Y-1897 *
A17-3200-C-1511	A4-3200-Y-1897 *
A24-3200-Z-1560	A17-3200-P-1706
A26-3200-Z-1560	A1-3200-P-1706
A27-3200-Z-1560	A1-3200-T-1892
A9-3200-P-1628	A1-3200-V-1894
A12-3200-P-1628	A4-3200-V-1894
A14-3200-P-1628	A9-3200-V-1894
A1-3200-J-1648	A1-3200-X-1818
A4-3200-J-1648	A4-3200-X-1818
A1-3200-T-1658	A1-3200-P-1706
A13-3200-T-1658	A17-3200-P-1706
A1-3200-V-1660	A1-3200-T-1892
A1-3200-K-1701	A1-3200-V-1894
A4-3200-K-1701	A4-3200-V-1894
A6-3200-K-1701	A9-3200-V-1894
A1-3200-M-1703	A1-3200-X-1818
A4-3200-M-1703	A4-3200-X-1818
A1-3200-P-1706	B57-3200-P-1706
A17-3200-P-1706	B58-3200-P-1706
A1-3200-R-1708	A1-3200-T-1892

ORIGINAL PART NUMBER	REPLACEMENT PART NUMBER
A1-3200-V-1712	A1-3200-Y-1897 *
A4-3200-V-1712	A4-3200-Y-1897 *
A11-3200-V-1712	A11-3200-E-1825
A1-3200-W-1713	A1-3200-W-1895
A1-3200-X-1818	A-3200-J-2116S
A4-3200-X-1818	A1-3200-J-2116S
A1-3200-Y-1819	A1-3200-W-1895
A1-3200-Z-1820	A1-3200-V-1894
A4-3200-Z-1820	A4-3200-V-1894
A6-3200-Z-1820	A9-3200-V-1894
A1-3200-C-1823	A1-3200-T-1892
A1-3200-E-1825	A1-3200-Y-1897 *
A4-3200-E-1825	A4-3200-Y-1897 *
A1-3200-T-1892	A34-3200-T-1892
A1-3200-V-1894	A3-3200-K-2117S
A4-3200-V-1894	A-3200-K-2117S
A9-3200-V-1894	A1-3200-K-2117S
A1-3200-W-1895	A3-3200-L-2118S
A1-3200-Y-1897	A23-3200-Y-1897 *
A4-3200-Y-1897	A22-3200-Y-1897 *

The part number supercessions listed here reflect product improvements made in several key areas. Several of these product improvements are non-interchangeable at the component level, in these cases kits have been developed to ease your transition to the new designs.

With the exception of reverse shift carriers built for Navistar, all carriers equipped with driver controlled main differential lock now have a screw in shift cylinder. The Interaxle differential shift cylinder for these carriers is also a screw in type.

* No Longer Available - can use steel (malleable) version.

TABLE OF CONTENTS

	PAGE
Forward Carriers of Tandem Axles.....	2
Carriers for Single Axles and Rears of Tandem Axles.....	8
Output (Thru) Shaft Assembly Parts.....	14
Housing Assemblies and Wheel End Parts.....	15
Axle Shafts.....	16
Yokes and Flanges -	
Full Round Bearing Yokes.....	19
Wing Bearing Yokes.....	20
Easy Service Yokes.....	21
Companion Flanges.....	22
Axle Model to Carrier to Kit Cross Reference.....	23
Kits.....	28
Numerical Parts Listing.....	42

XpresswayPlus.ArvinMeritor.com

Don't forget about using *XpresswayPlus* for:

- Ordering parts online
- Order status
- Price and availability
- Invoice Lookup
- Parts Catalog
- Online e-mail or phone numbers for Customer Service, Information Services, Marketing, Catalog, and eSupport



XpresswayPlus.ArvinMeritor.com
For all of your parts-ordering needs

- Reference Library
- The Company Store
- Literature
- Dealer/Distributor locator

XpresswayPLUS is easy to use, can reduce phone calls, and save you valuable time.

CHART 1

FORWARD CARRIERS OF TANDEM AXLES

(Use with Figure 1, Inside Front Cover)

VISUAL IDENTIFICATION OF FORWARD CARRIERS

<p style="text-align: center;">IAD SHIFTER AND DIFF. LOCK - BOLT ON FOR 1628, 1701 SCREW-IN FOR 1820, 1894, 1909, 2117</p>  <p style="text-align: center;">FORWARD CARRIERS WITH IAD, DIFF. LOCK AND OIL PUMP 3200-P-1628, 3200-K-1701, 3200-Z-1820, 3200-V-1894, 3200-K-1909, 3200-K-2117</p>	<p style="text-align: center;">IAD SHIFTER AND DIFF. LOCK - BOLT ON FOR 1713 SCREW-IN FOR 1819, 1895, 1908, 2118</p>  <p style="text-align: center;">FORWARD CARRIERS WITH IAD AND DIFF. LOCK WITHOUT OIL PUMP 3200-W-1713, 3200-Y-1819, 3200-W-1895, 3200-J-1908, 3200-L-2118</p>
<p style="text-align: center;">IAD SHIFTER - SCREW-IN FOR 1820, 1858, 1894, 1909, 2117</p>  <p style="text-align: center;">FORWARD CARRIERS WITH IAD AND OIL PUMP WITHOUT DIFF. LOCK 3200-Z-1820, 3200-L-1858, 3200-V-1894, 3200-K-1909, 3200-K-2117</p>	<p style="text-align: center;">IAD SHIFTER - BOLT ON FOR 1648, 1703 SCREW-IN FOR 1818, 1837, 1857, 2116</p>  <p style="text-align: center;">FORWARD CARRIERS WITH IAD WITHOUT DIFF. LOCK OR OIL PUMP 3200-J-1648, 3200-M-1703, 3200-X-1818, 3200-Q-1837, 3200-K-1857, 3200-J-2116</p>

The following carriers are equipped with a thrust screw: 3200-Q-1837, 3200-K-1909, 3200-J-1908.

The following carriers are machined for Internal ABS Sensors: 3200-L-1857, 3200-L-1858.

FORWARD CARRIERS OF TANDEM AXLES

ITEM	DESCRIPTION	REMARKS	CARRIER	QTY	PART NUMBER		
1	Nut - input yoke & shaft		Included in KIT 2826	1	40-X-1233		
1A	Washer - input nut			1	1229-N-1730		
2, 3	Yoke & deflector assembly - input			1	SEE YOKE CHARTS		
4	Capscrew - input bearing cage			7	MS-212040-2		
5	Washer - input bearing cage			7	MWA-512		
6	Seal & sleeve assembly - input shaft			1	A1-1205-X-2728		
7, 10	Bearing, cage & cup assy. - input		All less pump	1	A-3226-S-1137		
			All with pump		A-3226-H-1126		
8	Shims - input bearing cage	Included in KIT 2429		Use as req.	.003"/.076mm		
					.005"/.127mm		
					.010"/.254mm		
9	O-ring - input bearing cage			1	5-X-1343		
10	Cup - input shaft bearing			1	HM813810		
11	Cone - input shaft bearing			1	HM813843		
12	Baffle - oil	Use without oil pump		1	3221-P-1004		
13	Washer - oil baffle			3	1229-E-1669		
14	Capscrew - oil baffle			3	MS-208016-1		
15, 1	Input shaft & nut assembly Input shaft, nut, ball & pin assy.		Carriers with pump	All less pump	1	A-3297-T-1606	
		All others			A1-3297-S-1605		
		For old style A1-3297-H-1022 input shaft			KIT 2624		
16	Thrust washer - helical drive gear	Included in KIT 2796		1	1229-S-4985		
17	Gear - helical drive gear			1	3892-T-4934		
18	Capscrew - inter-axle diff. case			8	MS-210045A-1		
19	Washer - inter-axle diff. case			8	1229-K-1597		
20, 18, 19	Case assembly - inter-axle			After 10/00	1	A5-3235-A-2393	
				Prior to 10/00. Includes Items 25 & 27		A1-3235-A-2393	
20,18, 19, 21, 22, 23, 27	Diff. case & pinion nest assy - inter-axle			Includes Items 25 & 27	1	A3-3235-A-2393	
21	Spider (cross) - inter-axle diff.			Included in KIT 2248	1	3278-N-300	
22	Pinion gear - inter-axle diff.				4	2233-K-245	
23	Thrust washer - inter-axle diff. pinion			4	1229-Q-2929		
24	Snap ring - inter-axle diff.			1	2297-S-5349		
25	Clutch collar - inter-axle diff.	Included in KIT 2796	After 10/00	1	3107-P-1212		
			Prior to 10/00. Includes Items 25 & 27		A1-3235-A-2393		
26	Side gear - inter-axle diff., rear			1	2234-T-1190		
27	Shift fork - inter-axle diff.			1	3296-B-1328		
28	Cone - rear side gear bearing			1	JLM714149		
29	Cup - rear side gear bearing			1	JLM714110		
30	Adjusting screw - shift shaft			1	41-X-1208		
31	Jam nut - adjusting screw			1	MN-312-1		
32	Spring - shift shaft return			1	2258-U-411		
33	Shift shaft - inter-axle diff.			1	KIT 2825		
34	Shift assy. - inter-axle diff. air	Screw-in style		1	KIT 2825		
		Bolt-on style			A-3261-L-350		
35	Capscrew - air shift assembly	Bolt-on style		4	10-X-1334		
36, 61, 62	Differential carrier & cap assembly	Less pump, Less diff. lock	Ratios - 3.07, 3.21, 3.42, 3.57, 3.73	3200-J-1648	1	KIT 2644	
			Ratios - 3.91, 4.10, 4.30, 4.56				Original design
			Ratios - 4.89, 5.38, 5.63, 6.14, 6.43, 6.83, 7.17				
			Internal ABS	3200-K-1857		A2-3200-K-1857	
			New differential bearing	3200-M-1703		KIT 2618	
			Screw-in IAD shifter, w/thrust screw	3200-Q-1837		A2-3200-Q-1837	
			Screw-in IAD shifter	3200-X-1818, 3200-J-2116		A2-3200-J-2116S	
		Less pump, With diff. lock	Screw-in IAD & main diff. shift cylinder, with thrust screw	3200-J-1908		A2-3200-J-1908	
			Original design	3200-W-1713		No Longer Available	
			Screw in IAD & main diff. shift cyl.	3200-W-1895, 3200-L-2118		A2-3200-L-2118S	
		With pump, Less diff. lock	Screw-in IAD shifter	3200-Y-1819		KIT 2764	
			Screw-in IAD shifter, w/thrust screw	3200-K-1909		A2-3200-K-1909	
			Internal ABS	3200-L-1858		A2-3200-L-1858	
			Screw-in IAD shifter	3200-V-1894, 3200-K-2117		A2-3200-K-2117S	
		3200-Z-1820		KIT 2766			

FORWARD CARRIERS OF TANDEM AXLES

ITEM	DESCRIPTION		REMARKS	CARRIER	QTY	PART NUMBER
36, 61, 62 (Cont)	Differential carrier & cap assembly	With pump, With diff. lock	New differential bearing	3200-K-1701	1	KIT 2616
			Screw-in IAD & main diff. shift cylinder, with thrust screw	3200-K-1909		A2-3200-K-1909
			Ratios - 3.07, 3.21, 3.42, 3.58, 3.73	3200-P-1628 Original design		KIT 2640
			Ratios - 3.91, 4.10, 4.30, 4.56			KIT 2640A
			Ratios - 4.89, 5.38, 5.63, 6.14, 6.43, 6.83, 7.17			KIT 2640B
			Screw-in IAD & main diff. shift cylinder	3200-V-1894 3200-K-2117		A2-3200-K-2117S
Screw-in IAD shifter	3200-Z-1820	KIT 2763				
36A	Thrust screw (not shown)				1	15-X-1167
36B	Jam nut (not shown)				1	1227-D-472
37	Washer - carrier to housing		Ref. only - not included with any carrier		12	1229-W-1557
38	Nut - carrier to housing stud				2	NL-110-1
39	Capscrew - carrier to housing	Long			3	10-X-1599
		Short			7	10-X-1594
40, 50	Drive gear pinion & nut assembly		3.07 Ratio		Use 1 as req.	A-39654-1
			3.21 Ratio			A-39656-1
			3.42 Ratio			A-39658-1
			3.58 Ratio			A-39660-1
			3.73 Ratio			A-39662-1
			3.91 Ratio			A-39876-1
			4.10 Ratio			A-39878-1
			4.30 Ratio			A-39880-1
			4.56 Ratio			A-39882-1
			4.89 Ratio			A-39664-1
			5.38 Ratio			A-39666-1
			5.63 Ratio			A-39672-1
			6.14 Ratio			A-39674-1
			6.43 Ratio			A-39892-1
6.83 Ratio	A-41064-1					
7.17 Ratio	A-39896-1					
41	Cone - drive pinion inner bearing				1	H715343
42	Cup - drive pinion inner bearing				1	H715311
43	Shims - pinion inner bearing cup	.003"/.076mm	Included in KIT 2429		Use as req.	2203-F-2788
		.005"/.127mm				2203-G-2789
		.010"/.254mm				2203-H-2790
44	Spacer - pinion bearing inner				1	1244-W-1765
45	Gear - helical driven				1	3892-U-4909
46	Spacers - pinion bearing outer (variable thickness)	.451"/11.45mm	Included in KIT 2397		Use 2 as req.	2203-V-9824
		.452"/11.48mm				2203-W-9825
		.453"/11.50mm				2203-X-9826
		.454"/11.53mm				2203-Y-9827
		.455"/11.55mm				2203-Z-9828
		.459"/11.65mm				2203-A-9829
		.463"/11.75mm				2203-B-9830
		.467"/11.85mm				2203-C-9831
		.470"/11.95mm				2203-D-9832
		.474"/12.05mm				2203-E-9833
		.478"/12.15mm				2203-F-9834
		.482"/12.25mm				2203-G-9835
		.483"/12.28mm				2203-H-9836
		.484"/12.30mm				2203-J-9838
.485"/12.33mm	2203-K-9839					
.486"/12.35mm	2203-L-9840					
47	Cup - drive pinion outer bearing				1	65500
48	Cone - drive pinion outer bearing				1	65237
49	Washer - drive pinion				1	1229-G-4063
50	Nut - drive pinion				1	40-X-1145
51	Cover - drive pinion				1	3266-C-1095
52	Washer - drive pinion cover				5	1229-K-1597
53	Capscrew - drive pinion cover				5	MS-210020-1
54	Adjusting rings - diff. bearing		Both sides	1628, 1648 carriers	2	2214-U-1269
				3200-K-1857 (ABS)		2214-Z-1144

FORWARD CARRIERS OF TANDEM AXLES

ITEM	DESCRIPTION	REMARKS	CARRIER	QTY	PART NUMBER
54 (Cont)	Adjusting rings - diff. bearing (Cont)	LH side	3200-L-1858 (ABS)	1	KIT 2830
		RH side			2214-Z-1144
		LH side	3200-Z-1820, 3200-V-1894, 3200-W-1895		2214-J-1128
		RH side			2214-G-1125
		Both sides	All other non-ABS	2	2214-G-1125
55	Cups - diff. bearing	Both sides	1628, 1648 carriers	2	A1-1228-B-600
			1703, 1818, 1837 carriers		592A
		LH side	All others	1	52618
		RH side			592A
56	Cones - diff. bearing	Both sides	1628, 1648 carriers	2	A1-1228-B-600
			1703, 1818, 1837 carriers		594A
		LH side	All others	1	52400
		RH side			594A
57	Capscrew - main diff. case			12	41-X-1275
58	Washer - main diff. case			12	1229-U-1503
59, 57, 58	Case assembly - main diff.	Ratios - 3.07, 3.21, 3.42, 3.58, 3.73	3200-J-1648 Less diff. lock	Use 1 as req.	A10-3235-S-1813
		Ratios - 3.91, 4.10, 4.30, 4.56			A10-3235-F-1982
		Ratios - 4.89, 5.38, 5.63, 6.14, 6.43, 6.83, 7.17			A10-3235-H-1984 ²³
		Ratios - 3.07, 3.21, 3.42, 3.58, 3.73	3200-K-1701, 3200-W-1713, 3200-Y-1819, 3200-Z-1820, 3200-V-1894, 3200-W-1895, 3200-J-1908, 3200-K-1909, 3200-K-2117, 3200-L-2118 With diff. lock		A2-3235-C-2109
		Ratios - 3.91, 4.10, 4.30, 4.56			A2-3235-E-2111
		Ratios - 4.89, 5.38, 5.63, 6.14, 6.43, 6.83, 7.17			A2-3235-G-2113
		Ratios - 3.07, 3.21, 3.42, 3.58, 3.73	3200-K-1701, 3200-Z-1820, 3200-V-1894, 3200-K-1909, 3200-K-2117 Less diff. lock		A5-3235-C-2109
		Ratios - 3.91, 4.10, 4.30, 4.56			A5-3235-E-2111
		Ratios - 4.89, 5.38, 5.63, 6.14, 6.43, 6.83, 7.17			A5-3235-G-2113
		Ratios - 3.07, 3.21, 3.42, 3.58, 3.73	3200-M-1703, 3200-X-1818, 3200-Q-1837, 3200-J-2116 Less diff. lock		A-3235-C-2109
		Ratios - 3.91, 4.10, 4.30, 4.56			A-3235-E-2111
		Ratios - 4.89, 5.38, 5.63, 6.14, 6.43, 6.83, 7.17			A-3235-G-2113
		Ratios - 3.07, 3.21, 3.42, 3.58, 3.73	3200-P-1628 With diff. lock		A12-3235-S-1813
		Ratios - 3.91, 4.10, 4.30, 4.56			A12-3235-F-1982
		Ratios - 4.89, 5.38, 5.63, 6.14, 6.43, 6.83, 7.17			A12-3235-H-1984 ²³
59, 57, 58, 64, 65, 66, 67, 68	Case & nest assembly - main diff.	Ratios - 3.07, 3.21, 3.42, 3.58, 3.73	3200-J-1648 Less diff. lock	Use 1 as req.	A11-3235-S-1813
		Ratios - 3.91, 4.10, 4.30, 4.56			A11-3235-F-1982
		Ratios - 4.89, 5.38, 5.63, 6.14, 6.43, 6.83, 7.17			A11-3235-H-1984 ²³
		Ratios - 3.07, 3.21, 3.42, 3.58, 3.73	3200-K-1701, 3200-W-1713, 3200-Y-1819, 3200-Z-1820, 3200-V-1894, 3200-W-1895, 3200-J-1908, 3200-K-1909, 3200-K-2117, 3200-L-2118 With diff. lock		A3-3235-C-2109
		Ratios - 3.91, 4.10, 4.30, 4.56			A3-3235-E-2111
		Ratios - 4.89, 5.38, 5.63, 6.14, 6.43, 6.83, 7.17			A3-3235-G-2113
		Ratios - 3.07, 3.21, 3.42, 3.58, 3.73	3200-K-1701, 3200-Z-1820, 3200-V-1894, 3200-K-1909, 3200-K-2117 Less diff. lock		A6-3235-C-2109
		Ratios - 3.91, 4.10, 4.30, 4.56			A6-3235-E-2111
		Ratios - 4.89, 5.38, 5.63, 6.14, 6.43, 6.83, 7.17			A6-3235-G-2113
		Ratios - 3.07, 3.21, 3.42, 3.58, 3.73	3200-M-1703, 3200-X-1818, 3200-Q-1837, 3200-J-2116 Less diff. lock		A1-3235-C-2109
		Ratios - 3.91, 4.10, 4.30, 4.56			A1-3235-E-2111
		Ratios - 4.89, 5.38, 5.63, 6.14, 6.43, 6.83, 7.17			A1-3235-G-2113
		Ratios - 3.07, 3.21, 3.42, 3.58, 3.73	3200-P-1628 With diff. lock		A13-3235-S-1813
		Ratios - 3.91, 4.10, 4.30, 4.56			A13-3235-F-1982
		Ratios - 4.89, 5.38, 5.63, 6.14, 6.43, 6.83, 7.17			A13-3235-H-1984 ²³
59, 57, 58, 64, 173, 174, 175	Case & nest assembly - main diff.	Ratios - 3.07, 3.21, 3.42, 3.58, 3.73	3200-K-1857, Internal ABS, Less diff. lock, Less pump	Use 1 as req.	A2-3235-R-2176 ²³
		Ratios - 3.91, 4.10, 4.30, 4.56			A2-3235-S-2177 ²³
		Ratios - 4.89, 5.38, 5.63, 6.14, 6.43, 6.83, 7.17			A2-3235-T-2178 ²³
		Ratios - 3.07, 3.21, 3.42, 3.58, 3.73	3200-L-1858, Internal ABS, Less diff. lock, With pump		A4-3235-R-2176 ²³
		Ratios - 3.91, 4.10, 4.30, 4.56			A4-3235-S-2177 ²³
Ratios - 4.89, 5.38, 5.63, 6.14, 6.43, 6.83, 7.17			A4-3235-T-2178 ²³		

23 No Longer Available – Contact Florence Specifications for assistance

FORWARD CARRIERS OF TANDEM AXLES

ITEM	DESCRIPTION	REMARKS	CARRIER	QTY	PART NUMBER
59, 57, 58, 68A	Case & NoSpin assembly - main diff.	Ratios - 3.07, 3.21, 3.42, 3.58, 3.73	3200-J-1648	Use 1 as req.	A14-3235-S-1813
		Ratios - 3.91, 4.10, 4.30, 4.56			A14-3235-F-1982
		Ratios - 4.89, 5.38, 5.63, 6.14, 6.43, 6.83, 7.17			A14-3235-H-1984 ²³
		Ratios - 3.07, 3.21, 3.42, 3.58, 3.73	3200-K-1701, 3200-Z-1820, 3200-V-1894, 3200-K-1909		A8-3235-C-2109
		Ratios - 3.91, 4.10, 4.30, 4.56			A8-3235-E-2111
		Ratios - 4.89, 5.38, 5.63, 6.14, 6.43, 6.83, 7.17			A8-3235-G-2113
		Ratios - 3.07, 3.21, 3.42, 3.58, 3.73	3200-M-1703, 3200-X-1818, 3200-Q-1837		A7-3235-C-2109
Ratios - 3.91, 4.10, 4.30, 4.56	A7-3235-E-2111				
Ratios - 4.89, 5.38, 5.63, 6.14, 6.43, 6.83, 7.17	A7-3235-G-2113				
59, 57, 58, 173, 174, 175	Case assembly - main diff. (ABS ready)	Ratios - 3.07, 3.21, 3.42, 3.58, 3.73	3200-K-1857, Internal ABS, Less diff. lock, Less pump	Use 1 as req.	A1-3235-R-2176 ²³
		Ratios - 3.91, 4.10, 4.30, 4.56			A1-3235-S-2177 ²³
		Ratios - 4.89, 5.38, 5.63, 6.14, 6.43, 6.83, 7.17			A1-3235-T-2178 ²³
		Ratios - 3.07, 3.21, 3.42, 3.58, 3.73	3200-L-1858, Internal ABS, Less diff. lock, With pump		A5-3235-R-2176 ²³
		Ratios - 3.91, 4.10, 4.30, 4.56			A5-3235-S-2177 ²³
Ratios - 4.89, 5.38, 5.63, 6.14, 6.43, 6.83, 7.17	A3-3235-T-2178 ²³				
60	Bolt - gear to diff. case	Included in KIT 2426		12	41-X-1276
61	Washer - diff. bearing cap			4	42-X-1024
62	Capscrew - diff. bearing cap			4	41-X-1018
63	Pin - adjusting ring lock		ABS carriers	2	19-X-1087
			All others	1	KIT 4284
64	Thrust washer - side gear	Included in KIT 2318 with spider, KIT 2341 less spider		2	1229-L-3002
65	Side gear - diff.			2	2234-C-1069
66	Spider - diff. (cross)			1	3278-W-335
67	Gear - diff. pinion			4	2233-M-1001
68	Thrust washer - diff. pinion			4	1229-K-3001
68A	No-Spin assembly			1	A-3230-C-1043
69	Washer - gear to diff. case	Included in KIT 2426		12	1229-U-1503
70	Nut - gear to diff. case			12	40-X-1182

THE FOLLOWING PARTS ARE FOR MAIN DIFFERENTIAL LOCK

71	DCDL switch kit			1	KIT 4429
Not Shown	Plug - DCDL switchport	Non-DCDL applications only		1	41-X-1022
72	Lock nut - sensor/switch		Used on carriers with 3266-F-1020 air cyl. cover prior to 11/93	1	1227-P-1056
73	Spring - main diff. lock		After 11/93	1	2258-N-1262
			Prior to 11/93		2258-L-714
74	Roll pin - spring retaining		Prior to 11/93	1	43-X-1006
75	Shift shaft - main diff. lock		3200-P-1628	1	2244-Y-51
			After 11/93		KIT 2824
			All others prior to 11/93		2244-L-1026
76	Washer - piston		3200-P-1628	1	42-X-1027
77	Piston - main diff. lock		After 11/93	1	KIT 2824
			Prior to 11/93		2230-N-170
78	O-ring - piston		After 11/93	1	5-X-1198
			Prior to 11/93		5-X-1153
79	Tube - air cylinder		Prior to 11/93	1	3196-F-32
80	Gasket - air cylinder cover		Prior to 11/93	1	2208-H-944
81	Capscrew - manual engaging		After 11/93	1	41-X-1368
			Prior to 11/93		41-X-1333
81A	O-ring			1	5-X-521
82	Cover - air cylinder	Screw-in style	After 11/93	1	KIT 2824
		Bolt-on style	Prior to 11/93		3266-F-1020
82A	Plug - screw-in DCDL cylinder hole	Non-DCDL applications only		1	1250-U-1217
83	Plug - air cylinder cover		Prior to 11/93	1	MS-210016-1
84	Gasket - plug		Prior to 11/93	1	2208-L-1000
85	Capscrew - air cylinder cover		Prior to 11/93	4	41-X-1364
86	Washer - air cylinder cover		Prior to 11/93	4	MWA-506
87	Clutch collar - main diff. lock		3200-P-1628	1	3107-F-1020
			All others		3107-B-1094

FORWARD CARRIERS OF TANDEM AXLES

ITEM	DESCRIPTION	REMARKS	CARRIER	QTY	PART NUMBER
88	Shift fork - main diff. lock	Three pc. design	3200-Z-1560	1	3296-B-184
		One pc. design	After 11/93		3296-B-1172
			Prior to 11/93		3296-Y-1169 ¹
89	Pin - shift fork	Three pc. design		2	43-X-1007

THE FOLLOWING PARTS ARE FOR OIL PUMP

90	Shield - filter			1	3264-N-1522
91	Plug - oil pressure relief valve	Eliminated on carriers built after 5/97		1	1250-N-1080
92	Washer - plug			1	1229-F-4062
93	Spring - oil pressure relief valve			1	2258-Z-1118
94	Pressure relief valve - oil			1	2297-U-5273
95	Dowel - input cage to oil pump	No longer used		2	1246-M-1131
96	O-ring - oil pump			1	5-X-1034
97	Oil pump assembly		All others	1	A-3303-P-1030
			For old style A1-3297-H-1022 input shaft		KIT 2624
98	Washer - oil pump			6	1229-E-1669
99	Capscrew - oil pump			6	MS-208045-1
100	Oil filter			1	3280-V-8394
101	Adaptor - oil filter			1	2297-Z-5278
102	Screen & plug assembly - oil filter			1	A-2297-D-5334

THE FOLLOWING PARTS ARE FOR THE CARRIERS WITH INTERNAL A.B.S. SENSORS

169	Wave washer - adjusting ring			2	2258-G-1255
170	Snap ring - connector			2	1229-U-4519
171	Snap ring - adjusting ring			2	1229-F-4452
172	Sensor - ABS	Both sides	3200-K-1857	2	SA1-3280-X-9150
		LH side	3200-L-1858	1	SA2-3280-X-9150
		RH side			SA1-3280-X-9150
172A	Plug - sensor attaching (not shown)	Pump carrier only	3200-L-1858 (LH side)	1	1250-T-1216
173	Drive tube			2	3216-G-4375
174	Washer - drive tube			2	42-X-1408
175	Snap ring - drive tube			2	1229-D-4528



If you detect any **errors** in this catalog, please let us know.

We want the information to be as accurate as possible; we appreciate your help in making it so.

Please e-mail any comments/suggestions/corrections to us at: catalogfeedback@arvinmeritor.com

or mail to: ArvinMeritor
attn: Catalog Dept.
7975 Dixie Highway
Florence, KY 41042

¹ Prior to 11/92 all carriers (except 3200-Z-1560) used the three piece design fork (3296-R-1084) which was replaced by 3296-Y-1169 in 11/92.

CHART 2

CARRIERS FOR SINGLE AXLES AND REARS OF TANDEM AXLES

(Use with Figure 2, Inside Front Cover)

VISUAL IDENTIFICATION OF REAR CARRIERS



The following carriers are equipped with a thrust screw: 3200-A-1821, 3200-D-1928, 3200-E-1929

The following carriers are machined for Internal ABS Sensors: 3200-H-1854, 3200-J-1856

The following carriers are available with and without Diff. Lock: 3200-C-1511, 3200-Z-1560, 3200-V-1712,
3200-E-1825, 3200-Y-1897, 3200-E-1929

CARRIERS FOR SINGLE AXLES AND REARS OF TANDEM AXLES

ITEM	DESCRIPTION	REMARKS	CARRIER	QTY	PART NUMBER	
115	Nut - drive pinion			1	40-X-1233	
115A	Washer - pinion nut			1	1229-N-1730	
116, 117	Input yoke assembly			1	SEE YOKE CHARTS	
118	Oil seal assembly - rear pinion			1	A1-1205-A-2731	
119	Cone - drive pinion outer bearing			1	HM813843	
120	Cup - drive pinion outer bearing			1	HM813810	
121	Capscrew - pinion bearing cage			8	MS-212045-1	
122	Washer - pinion bearing cage			8	MWA-512	
123	Pinion bearing cage & cups assembly			1	A-3226-R-1006	
124	Shims - pinion bearing cage	.002"/.050mm	Included in KIT 1592	Use as req.	2803-Y-2755	
		.005"/.125mm			2803-Z-2756	
		.008"/.200mm			2803-A-2757	
		.020"/.500mm			2803-B-2758	
125	Spacers - pinion bearing	.250"/6.35mm	Included in KIT 1593	Use 2 as req.	2803-D-2500	
		.251"/6.38mm			2803-E-2501	
		.252"/6.40mm			2803-F-2502	
		.253"/6.43mm			2803-N-2510	
		.254"/6.45mm			2803-G-2503	
		.256"/6.50mm			2803-H-2504	
		.260"/6.60mm			2803-J-2506	
		.261"/6.63mm			2803-K-2507	
		.262"/6.65mm			2803-L-2508	
		.263"/6.68mm			2803-M-2509	
126	Cup - drive pinion inner bearing			1	9220	
127	Cone - drive pinion inner bearing			1	1228-V-594	
128, 115	Drive gear, pinion & nut assy.	2.50 ratio		Use 1 as req.	B-42776-1 ⁹	
		2.67 ratio			B-43454-1 ⁹	
		2.80 ratio			A-41572-1	
		2.93 ratio			A-41574-1	
		3.07 ratio			A-39898-5 ³	
		3.21 ratio			A-42002-1 ²	
		3.42 ratio			A-39900-5 ³	
		3.58 ratio			A-41990-1 ²	
		3.73 ratio			A-39902-5 ³	
		3.91 ratio			A-42004-1 ²	
		4.10 ratio			A-39904-5 ³	
		4.30 ratio			A-41992-1 ²	
		4.56 ratio			A-39906-5 ³	
		4.89 ratio			A-41994-1 ²	
		5.13 ratio			A-42466-1 ²	
		5.29 ratio			A-39884-5 ⁴	
		5.38 ratio			A-39886-5 ⁴	
		5.63 ratio			A-42006-1 ²	
		6.14 ratio			A-39888-5 ⁴	
		6.43 ratio			A-41996-1 ²	
6.83 ratio	A-39890-5 ⁴					
7.17 ratio	A-41988-1 ²					
129	Spigot bearing - drive pinion	One piece bearing	Use for carriers that have been upgraded to snap ring gearsets only	1	1228-Y-1221	
					Use with new snap ring design	1228-B-1042
		Two piece bearing			Use with original non-snap ring design	A1-1228-P-1004

2 Quietride™ gearing.

4 Use KIT 2468 + Ratio to upgrade the 3200-Z-1560 carriers.
Use KIT 2655 + Ratio to upgrade the 3200-C-1511 carriers.

3 For 3200-C-1511, 3200-Z-1560, 3200-T-1658 & 3200-V-1660 use -6 gearsets, except for 6.83 ratio use -2 gearset.

9 Use only in carriers made after 3/6/06.

24 No Longer Available

CARRIERS FOR SINGLE AXLES AND REARS OF TANDEM AXLES

ITEM	DESCRIPTION	REMARKS	CARRIER	QTY	PART NUMBER	
129A	Snap ring - spigot bearing	Use with 1228-B-1042 and 1228-Y-1221		1	46-X-1029	
130, 131 & 132	Differential carrier & cap assy.	Less differential lock	With thrust screw	3200-A-1821	1	A2-3200-A-1821
			Ratios - 3.07, 3.21, 3.42, 3.58, 3.73	3200-C-1511 Aluminum		KIT 2657
			Ratios - 3.91, 4.10, 4.30, 4.56			KIT 2657A
			Ratios - 4.89, 5.38, 5.63, 6.14, 6.43, 6.83, 7.17	3200-E-1825 3200-E-1929		KIT 2657B
			Aluminum			No Longer Available
			Aluminum, ABS	3200-H-1854		A2-3200-E-1929
			Internal ABS	3200-J-1856		A2-3200-H-1854
			New bearings	3200-P-1706		A2-3200-J-1856
			New bearings / tapered dowels	3200-E-2137		A2-3200-P-1706
			Aluminum	3200-V-1712		A2-3200-E-2137
				3200-Y-1897		KIT 2634
			Ratios - 3.07, 3.21, 3.42, 3.58, 3.73	3200-Z-1560 Original design,		KIT 2642
		Ratios - 3.91, 4.10, 4.30, 4.56	KIT 2642A			
		Ratios - 4.89, 5.38, 5.63, 6.14, 6.43, 6.83, 7.17	3200-T-1658 Wide leg design	KIT 2642B		
		With differential lock		Ratios - 3.07, 3.21, 3.42, 3.58, 3.73	3200-C-1511 Aluminum	KIT 2658
			Ratios - 3.91, 4.10, 4.30, 4.56	KIT 2658A		
			Ratios - 4.89, 5.38, 5.63, 6.14, 6.43, 6.83, 7.17	KIT 2658B		
			Revised diff. lock	3200-C-1823	KIT 2762	
			Malleable w/screw-in main diff. shifter	3200-D-1928	A2-3200-D-1928	
			Aluminum	3200-E-1825	No Longer Available	
			Aluminum w/screw-in main diff. shifter	3200-E-1929	A2-3200-E-1929	
			New bearings	3200-R-1708	KIT 2659	
			Malleable w/screw-in main diff. shifter	3200-T-1892	A2-3200-T-1892	
			Malleable w/screw-in main diff. shifter / with tapered dowels	3200-F-2138	A2-3200-F-2138	
Aluminum	3200-V-1712		No Longer Available			
Aluminum w/screw-in main diff. shifter	3200-Y-1897		A2-3200-Y-1897			
Ratios - 3.07, 3.21, 3.42, 3.58, 3.73	3200-Z-1560 Original design,	KIT 2643				
Ratios - 3.91, 4.10, 4.30, 4.56		KIT 2643A				
Ratios - 4.89, 5.38, 5.63, 6.14, 6.43, 6.83, 7.17		KIT 2643B				
130A	Thrust screw (not shown)			1	15-X-1167	
130B	Jam nut (not shown)			1	1227-D-472	
131	Washer - diff. bearing cap			4	42-X-1024	
132	Capscrew - diff. bearing cap			4	41-X-1018	
133	Adjusting ring - diff. bearing	LH & RH	1511, 1560, 1658, 1660	2	2214-U-1269	
		LH	1708, 1712, 1823, 1825,		1	2214-G-1125
		RH	1892, 1897, 1928, 2138	2214-J-1128		
		LH	3200-H-1854 (ABS)	2	KIT 2830	
		RH			2214-Z-1144	
		LH & RH	3200-J-1856 (ABS)	2	2214-Z-1144	
134	Pin - adjusting ring		3200-P-1706	2	2214-G-1125	
			ABS carriers		19-X-1087	
135	Cup - differential bearing		All others	1	KIT 4284	
		LH & RH	1511, 1560, 1658, 1660	2	A1-1228-B-600	
135A	Adhesive - diff. bearing cup	LH	1708, 1712, 1823, 1825,	1	592A	
		RH	1892, 1897, 1928, 1929, 2138		52618	
		LH & RH	3200-P-1706		2	592A
136	Cone - differential bearing	LH & RH	1511, 1560, 1658, 1660	2	A1-1228-B-600	
		LH	1708, 1712, 1823, 1825,		1	594A
		RH	1892, 1897, 1928, 1929, 2138	52400		
		LH & RH	3200-P-1706	2	594A	
137	Nut - diff. case to gear	Included in KIT 2426		12	40-X-1182	
138	Washer - diff. case to gear			12	1229-U-1503	
139	Bolt - diff. case to gear			12	41-X-1276 ¹⁰	

7 No longer available

10 For Coach Quality use 41-X-1555 (KIT 4745)

CARRIERS FOR SINGLE AXLES AND REARS OF TANDEM AXLES

ITEM	DESCRIPTION	REMARKS	CARRIER	QTY	PART NUMBER
140 thru 147	Case & nest assy. - main diff. All shown are 2.38"-46 axle spline.	Ratios - 3.07, 3.21, 3.42, 3.58, 3.73, 3.91, 4.10, 4.30, 4.56	3200-C-1511 Aluminum Less diff. lock	Use 1 as req.	A11-3235-S-1813 ⁵
		Ratios - 3.91, 4.10, 4.30, 4.56			A11-3235-F-1982 ⁶
		Ratios - 4.89, 5.38, 5.63, 6.14, 6.43, 6.83, 7.17			A11-3235-H-1984 ²³
		Ratios - 3.07, 3.21, 3.42, 3.58, 3.73, 3.91, 4.10, 4.30, 4.56	3200-C-1511 Aluminum With diff. lock		A13-3235-S-1813 ⁵
		Ratios - 3.91, 4.10, 4.30, 4.56			A13-3235-F-1982 ⁶
		Ratios - 4.89, 5.38, 5.63, 6.14, 6.43, 6.83, 7.17			A13-3235-H-1984 ²³
		Ratios - 2.50, 2.67, 2.80, 2.93	3200-P-1706, 3200-A-1821, 3200-E-2137 Less diff. lock		A1-3235-R-2202
		Ratios - 3.07, 3.21, 3.42, 3.58, 3.73			A1-3235-C-2109 ¹¹
		Ratios - 3.91, 4.10, 4.30, 4.56			A1-3235-E-2111 ¹²
		Ratios - 4.89, 5.38, 5.63, 6.14, 6.43, 6.83, 7.17	3200-R-1708, 3200-V-1712 Alum., 3200-C-1823, 3200-E-1825 Alum., 3200-T-1892, 3200-Y-1897 Alum., 3200-D-1928, 3200-E-1929 Alum., 3200-F-2138 With diff. lock		A1-3235-G-2113 ¹³
		Ratios - 2.50, 2.73, 2.80, 2.93			A3-3235-R-2202
		Ratios - 3.07, 3.21, 3.42, 3.58, 3.73			A3-3235-C-2109 ¹⁴
		Ratios - 3.91, 4.10, 4.30, 4.56	3200-T-1658 Less diff. lock		A3-3235-E-2111 ¹⁵
		Ratios - 4.89, 5.38, 5.63, 6.14, 6.43, 6.83, 7.17			A3-3235-G-2113 ¹⁶
		Ratios - 3.07, 3.21, 3.42, 3.58, 3.73			A11-3235-S-1813
		Ratios - 3.91, 4.10, 4.30, 4.56	3200-V-1600 With diff. lock		A11-3235-F-1982
		Ratios - 4.89, 5.38, 5.63, 6.14, 6.43, 6.83, 7.17			A11-3235-H-1984 ²³
		Ratios - 3.07, 3.21, 3.42, 3.58, 3.73			A13-3235-S-1813
		Ratios - 3.91, 4.10, 4.30, 4.56	3200-V-1712, 3200-E-1825, 3200-Y-1897, 3200-E-1929, Aluminum, Less diff. lock		A13-3235-F-1982
		Ratios - 4.89, 5.38, 5.63, 6.14, 6.43, 6.83, 7.17			A13-3235-H-1984 ²³
		Ratios - 3.07, 3.21, 3.42, 3.58, 3.73, 3.91, 4.10, 4.30, 4.56			A6-3235-C-2109
		Ratios - 3.91, 4.10, 4.30, 4.56	3200-Z-1560 With or Without diff. lock		A6-3235-E-2111
		Ratios - 4.89, 5.38, 5.63, 6.14, 6.43, 6.83, 7.17			A6-3235-G-2113
		Ratios - 3.07, 3.21, 3.42, 3.58, 3.73, 3.91, 4.10, 4.30, 4.56			A2-3235-S-1813 ⁵ plus KIT 2318
Ratios - 4.89, 5.38, 5.63, 6.14, 6.43, 6.83, 7.17	3200-H-1854, Internal ABS, Less diff. lock, Aluminum	A3-3235-F-1982 ⁶			
Ratios - 3.07, 3.21, 3.42, 3.58, 3.73, 3.91, 4.10, 4.30, 4.56		A3-3235-H-1984 ²³			
Ratios - 3.91, 4.10, 4.30, 4.56		A4-3235-R-2176 ²³			
Ratios - 4.89, 5.38, 5.63, 6.14, 6.43, 6.83, 7.17	3200-J-1856, Internal ABS, Less diff. lock, Malleable iron	A4-3235-S-2177 ²³			
Ratios - 3.07, 3.21, 3.42, 3.58, 3.73		A4-3235-T-2178 ²³			
Ratios - 3.91, 4.10, 4.30, 4.56		A2-3235-R-2176 ²³			
Ratios - 4.89, 5.38, 5.63, 6.14, 6.43, 6.83, 7.17	3200-C-1511 Aluminum Less diff. lock	A2-3235-S-2177 ²³			
Ratios - 3.07, 3.21, 3.42, 3.58, 3.73, 3.91, 4.10, 4.30, 4.56		A2-3235-T-2178 ²³			
Ratios - 3.91, 4.10, 4.30, 4.56		A14-3235-S-1813 ⁵			
Ratios - 4.89, 5.38, 5.63, 6.14, 6.43, 6.83, 7.17	3200-P-1706 Less diff. lock	A14-3235-F-1982 ⁶			
Ratios - 3.07, 3.21, 3.42, 3.58, 3.73		A14-3235-H-1984 ²³			
Ratios - 3.91, 4.10, 4.30, 4.56		A7-3235-C-2109			
Ratios - 4.89, 5.38, 5.63, 6.14, 6.43, 6.83, 7.17	3200-T-1658 Less diff. lock	A7-3235-E-2111			
Ratios - 3.07, 3.21, 3.42, 3.58, 3.73		A7-3235-G-2113			
Ratios - 3.91, 4.10, 4.30, 4.56		A14-3235-S-1813			
Ratios - 4.89, 5.38, 5.63, 6.14, 6.43, 6.83, 7.17	3200-V-1712, 3200-E-1825, 3200-Y-1897, Aluminum Less diff. lock	A14-3235-F-1982			
Ratios - 3.07, 3.21, 3.42, 3.58, 3.73		A14-3235-H-1984 ²³			
Ratios - 3.91, 4.10, 4.30, 4.56		A8-3235-C-2109			
Ratios - 4.89, 5.38, 5.63, 6.14, 6.43, 6.83, 7.17	3200-V-1712, 3200-E-1825, 3200-Y-1897, Aluminum Less diff. lock	A8-3235-E-2111			
Ratios - 3.07, 3.21, 3.42, 3.58, 3.73		A8-3235-G-2113			
Ratios - 3.91, 4.10, 4.30, 4.56					

5 For use with carriers built prior to Sept. 1, 1988.

(Applies to ratios 3.91 thru 4.56 only.)

11 For Coach Quality use A1-3235-Y-2469

12 For Coach Quality use A1-3235-P-2460

13 For Coach Quality use A1-3235-M-2457

23 No Longer Available – Contact Florence Specifications for assistance

6 For use with carriers produced after Sept. 1, 1988 or have been

retro-fitted with KIT 2468 or KIT 2655 only.

14 For Coach Quality use A3-3235-Y-2469

15 For Coach Quality use A3-3235-P-2460

16 For Coach Quality use A3-3235-M-2457

CARRIERS FOR SINGLE AXLES AND REARS OF TANDEM AXLES

ITEM	DESCRIPTION	REMARKS	CARRIER	QTY	PART NUMBER
140, 146 & 147	Case assy - main differential	Ratios - 3.07, 3.21, 3.42, 3.58, 3.73, 3.91, 4.10, 4.30, 4.56	3200-C-1511 Aluminum Less diff. lock	Use 1 as req.	A10-3235-S-1813 ⁵
		Ratios - 3.91, 4.10, 4.30, 4.56			A10-3235-F-1982 ⁶
		Ratios - 4.89, 5.38, 5.63, 6.14, 6.43, 6.83, 7.17			A10-3235-H-1984 ²³
		Ratios - 3.07, 3.21, 3.42, 3.58, 3.73, 3.91, 4.10, 4.30, 4.56	3200-C-1511 Aluminum With diff. lock		A12-3235-S-1813 ⁵
		Ratios - 3.91, 4.10, 4.30, 4.56			A12-3235-F-1982 ⁶
		Ratios - 4.89, 5.38, 5.63, 6.14, 6.43, 6.83, 7.17			A12-3235-H-1984 ²³
		Ratios - 2.50, 2.67, 2.80, 2.93	3200-P-1706, 3200-A-1821, 3200-E-2137 Less diff. lock		A-3235-R-2202
		Ratios - 3.07, 3.21, 3.42, 3.58, 3.73			A-3235-C-2109 ¹⁷
		Ratios - 3.91, 4.10, 4.30, 4.56			A-3235-E-2111 ¹⁸
		Ratios - 4.89, 5.38, 5.63, 6.14, 6.43, 6.83, 7.17	3200-R-1708, 3200-V-1712 Alum., 3200-C-1823, 3200-E-1825 Alum., 3200-T-1892, 3200-Y-1897 Alum., 3200-D-1928, 3200-E-1929 Alum., 3200-T-2138 With diff. lock		A-3235-G-2113 ¹⁹
		Ratios - 2.50, 2.67, 2.80, 2.93			A2-3235-R-2202
		Ratios - 3.07, 3.21, 3.42, 3.58, 3.73			A2-3235-C-2109 ²⁰
		Ratios - 3.91, 4.10, 4.30, 4.56	3200-T-1658 Less diff. lock		A2-3235-E-2111 ²¹
		Ratios - 4.89, 5.38, 5.63, 6.14, 6.43, 6.83, 7.17			A2-3235-G-2113 ²²
		Ratios - 3.07, 3.21, 3.42, 3.58, 3.73			A10-3235-S-1813
		Ratios - 3.91, 4.10, 4.30, 4.56	3200-V-1660 With diff. lock		A10-3235-F-1982
		Ratios - 4.89, 5.38, 5.63, 6.14, 6.43, 6.83, 7.17			A10-3235-H-1984 ²³
		Ratios - 3.07, 3.21, 3.42, 3.58, 3.73			A12-3235-S-1813
		Ratios - 3.91, 4.10, 4.30, 4.56	3200-V-1712, 3200-E-1825, 3200-Y-1897, 3200-E-1929, Aluminum, Less diff. lock		A12-3235-F-1982
		Ratios - 4.89, 5.38, 5.63, 6.14, 6.43, 6.83, 7.17			A12-3235-H-1984 ²³
		Ratios - 3.07, 3.21, 3.42, 3.58, 3.73, 3.91, 4.10, 4.30, 4.56			A5-3235-C-2109
		Ratios - 4.89, 5.38, 5.63, 6.14, 6.43, 6.83, 7.17	3200-Z-1560 Less diff. lock		A5-3235-E-2111
		Ratios - 3.07, 3.21, 3.42, 3.58, 3.73, 3.91, 4.10, 4.30, 4.56			A5-3235-G-2113
		Ratios - 4.89, 5.38, 5.63, 6.14, 6.43, 6.83, 7.17			A-3235-S-1813 ⁵
		Ratios - 3.07, 3.21, 3.42, 3.58, 3.73, 3.91, 4.10, 4.30, 4.56	3200-Z-1560 With diff. lock		A2-3235-F-1982 ⁶
		Ratios - 4.89, 5.38, 5.63, 6.14, 6.43, 6.83, 7.17			A-3235-H-1984 ²³
		Ratios - 3.07, 3.21, 3.42, 3.58, 3.73, 3.91, 4.10, 4.30, 4.56			A2-3235-S-1813 ⁵
		Ratios - 4.89, 5.38, 5.63, 6.14, 6.43, 6.83, 7.17	3200-H-1854, Internal ABS, Less diff. lock, Aluminum		A2-3235-F-1982 ⁶
		Ratios - 3.07, 3.21, 3.42, 3.58, 3.73, 3.91, 4.10, 4.30, 4.56			A2-3235-H-1984 ²³
		Ratios - 4.89, 5.38, 5.63, 6.14, 6.43, 6.83, 7.17			A5-3235-R-2176 ²³
140, 146, 147, 173, 174, 175	Case assy - main differential (ABS ready)	Ratios - 3.07, 3.21, 3.42, 3.58, 3.73	3200-J-1856, Internal ABS, Less diff. lock, Malleable iron	Use 1 as req.	A5-3235-S-2177 ²³
		Ratios - 3.91, 4.10, 4.30, 4.56			A3-3235-T-2178 ²³
		Ratios - 4.89, 5.38, 5.63, 6.14, 6.43, 6.83, 7.17			A1-3235-R-2176 ²³
141	Thrust washer - side gear	Included in KIT 2318	46 Spline	2	A5-3235-S-2177 ²³
					A1-3235-S-2177 ²³
					A1-3235-T-2178 ²³
142	Side gear - differential	Coach Quality . Included in KIT 2575	50 Spline	2	A1-3235-T-2178 ²³
					A1-3235-T-2178 ²³
					A1-3235-T-2178 ²³
142A	No-Spin assembly		46 Spline	1	A-3230-C-1043
143	Thrust washer - diff. pinion	Included in KIT 2318		4	1229-K-3001
144	Gear - diff. pinion				2233-M-1001
145	Spider diff.				3278-W-335
146	Washer - diff. case			12	1229-U-1503
147	Capscrew - diff. case			12	41-X-1275
147A	Thread locking liquid			1	2297-C-7049

5 For use with carriers built prior to Sept. 1, 1988.

(Applies to ratios 3.91 thru 4.56 only.)

17 For Coach Quality use A-3235-Y-2469

18 For Coach Quality use A-3235-P-2460

19 For Coach Quality use A-3235-M-2457

23 No Longer Available – Contact Florence Specifications for assistance

6 For use with carriers produced after Sept. 1, 1988 or have been

retro-fitted with KIT 2468 or KIT 2655 only.

20 For Coach Quality use A2-3235-Y-2469

21 For Coach Quality use A2-3235-P-2460

22 For Coach Quality use A2-3235-M-2457

CARRIERS FOR SINGLE AXLES AND REARS OF TANDEM AXLES

ITEM	DESCRIPTION	REMARKS	CARRIER	QTY	PART NUMBER
THE FOLLOWING PARTS ARE FOR MAIN DIFFERENTIAL LOCK					
148	DCDL Switch Kit			1	KIT 4429
Not Shown	Plug - sensor port			1	41-X-1022
149	Lock nut - sensor/switch	Prior to 11/93	Used on carriers with 3266-F-1020 air cyl. cover	1	1227-P-1056
150	Shift fork - main diff. lock	Three pc. design	3200-Z-1560	1	3296-B-184
		One pc. design	After 11/93		3296-B-1172
151	Spring - main diff. lock		Prior to 11/93	1	3296-Y-1169 ¹
			After 11/93		2258-N-1262
152	Shift shaft - main diff. lock		1511, 1560, 1660	1	2244-Y-51
			1708, 1712, 1823		2244-L-1026
			1892, 1897, 1928, 1929, 2138		KIT 2824
152A	Washer - piston (not shown)		Prior to 11/93	1	42-X-1027
153	Shift cylinder housing	Screw-in style	After 11/93	1	KIT 2824
	Tube - air cylinder	Bolt-on style	Prior to 11/93		3196-F-32
153A	Plug - cylinder hole			1	1250-U-1217
154	Piston - main diff. lock		After 11/93	1	KIT 2824
			Prior to 11/93		2230-N-170
155	Gasket - air cylinder cover		Prior to 11/93	1	2208-H-944
156	Capscrew - manual engaging		After 11/93	1	41-X-1368
			Prior to 11/93		41-X-1333
156A	O-ring			1	5-X-521
157	Cover - air cylinder	Bolt-on style	Prior to 11/93	1	3266-F-1020
158	Washer - adjusting ring lock capscrew			2	MWA-508
159	Capscrew - adjusting ring lock			2	MS-208020-1
160	Lock - adjusting ring			1	1220-K-89
161	Pin - shift fork	Three pc. design		2	43-X-1007
162	Clutch collar - main diff. lock		1511, 1660, 1628	1	3107-F-1020
		46 Spline	1708, 1712, 1823, 1825, 1892 1894, 1897, 1928, 1929, 2138		3107-B-1094
		50 Spline	1708, 1823		3107-C-1095
			3200-Z-1560		3107-P-1030
163	Roll pin - spring retaining		Prior to 11/93	1	43-X-1006
164	O-ring - piston		After 11/93	1	5-X-1198
			Prior to 11/93		5-X-1153
165	Washer - air cylinder cover		Prior to 11/93	4	MWA-506
166	Capscrew - air cylinder cover		Prior to 11/93	4	41-X-1364
167	Gasket - plug		Prior to 11/93	1	2208-L-1000
168	Plug - air cylinder cover		Prior to 11/93	1	MS-210016-1

THE FOLLOWING PARTS ARE FOR CARRIERS WITH INTERNAL A.B.S. SENSORS

169	Wave washer - adjusting ring			2	2258-G-1255
170	Snap ring - adjusting ring			2	1229-F-4452
171	Snap ring - sensor			2	1229-U-4519
172A	Plug - sensor attaching (not shown)	Aluminum only	3200-H-1854 (LH side)	1	1250-T-1216 ⁷
173	Drive tube			2	3216-G-4375 ⁷
174	Washer - drive tube			2	42-X-1408
175	Snap ring - drive tube			2	1229-D-4528
172	Sensor - ABS	LH side	3200-H-1854	1	SA2-3280-X-9150
		RH side			SA1-3280-X-9150
		Both sides	3200-J-1856	2	SA1-3280-X-9150

¹ Prior to 11/92 all carriers (except 3200-Z-1560) used the three piece design fork (3296-R-1084) which was replaced by 3296-Y-1169 in 11/92. ⁷ No Longer Available

OUTPUT (THRU) SHAFT ASSEMBLY PARTS



ITEM	DESCRIPTION	REMARKS	QTY	PART NUMBER
200	Output (thru) shaft, bearing cage and seal assy.	Includes Items 201, 202, 205 thru 211	1	A2-3226-T-1112S
201	Shaft - output (thru)		1	3297-V-1010
202	Bearing cage & inner cup assy. - output		1	A-3226-T-1112
202A	Deflector (no longer used)		1	N/A ⁸
203	Washer - output bearing cage capscrew		4	1229-K-1597
204	Capscrew - output bearing cage		4	15-X-387
205	Cups - inner & outer output bearing		2	JLM-104910
206	Cones - inner & outer output bearing		2	LM-104949
207	Snap ring (spacer) - output bearing	Included in KIT 576	Use 1 as req.	.155 inch
	.158 inch			
	.161 inch			
	.164 inch			
	.167 inch			
	.170 inch			
	.173 inch			
	.176 inch			
	.179 inch			
	.182 inch			
208	Snap ring spacer - output bearing/yoke		1	1229-W-4131
209	Oil seal - output bearing cage	2 piece (seal & sleeve)	1	A1-1205-Y-2729
210	Washer - yoke nut (output)	Included in KIT 2637	1	1229-T-1736
211	Nut - output yoke		1	40-X-1237

⁸ Use A1-1205-Y-2729 seal & sleeve. Do not use deflector.

HOUSING ASSEMBLY PARTS



ITEM	DESCRIPTION	REMARKS	COMMENTS	QTY	PART NUMBER
212	Axle housing assembly			1	AS SPECIFIED
213	Breather assembly - housing			1	KIT 2902
214	Stud - carrier to housing	Forward-rear only	Long	1	4-X-1922
			Short	1	4-X-1921
				2	4-X-1921
215	Plug - heat indicator		Use as required	1	P-28S
216	Plug - filler hole			1	P-212
217	Washer - carrier to housing nut	Forward-rear only	For 12 mtg. hole version	2	1229-W-1557
			For 15 mtg. hole version	3	1229-W-1557
218	Nut - carrier to housing stud	Forward-rear only	For 12 mtg. hole version	2	N-110-1
			For 15 mtg. hole version	3	N-110-1
			For 12 mtg. hole version	7	10-X-1594
			For 15 mtg. hole version	9	10-X-1594
219	Capscrew - carrier to housing	Forward-rear axles, RP & RD 23-160/164, 26-160/164	For tapered dowel versions ²³	5	10-X-1594
			For tapered dowel versions ²³	4	10-X-1595
			3-1/2" Long	3	10-X-1599
			All forwards	3	10-X-1599
		Rear-rear & single axles, RS & RR 23-160/164, 26-160/164	1-3/4" Long	8	10-X-1594
			For tapered dowel versions ²³	5	10-X-1594
			For tapered dowel versions ²³	3	10-X-1595
			For tapered dowel versions ²³	4	10-X-1600
220	Washer - carrier to housing capscrew	Forward-rear only	For 12 mtg. hole version	10	1229-W-1557
			For 15 mtg. hole version	12	1229-W-1557
221	Plug - drain (magnetic)	Rear-rear & singles		12	1229-W-1557
				1	1250-E-473
222	Oil seal assembly	Unitized		2	A-1205-Q-2487
		Use with wiper below		2	A-1205-T-696
222A	Wiper - housing spindle inner (optional)	Not shown	Chrome plated	2	1199E1669
223	Cone - bearing inner wheel			2	594A
224	Cup - bearing inner wheel			2	592A
225	Cup - bearing outer wheel			2	572
226	Cone - bearing outer wheel			2	580
227	Nut - bearing adjusting inner			2	1227-W-517
228	Washer - adjusting nut	Off-highway		2	1229-U-1009
229	Tanged washer & adjusting nut washer	On-highway		2	1229-F-4634S
230	Nut - outer jam			2	1227-R-330

²³ Dowel part number is 1246-V-1166. Quantity 6 for forward (KIT 4288) and quantity 4 for rear (KIT 4291).

AXLE SHAFT SETS FOR 160, 161 and 164 SERIES AXLES

LEFT HAND	RIGHT HAND
-----------	------------

RS-20-160 Single Axle

3202-Q-8805	3202-B-8816*
3202-Q-8805	3202-G-9003

RS-21-160 Single Axle

3202-Q-8805	3202-B-8816*
3202-Q-8805	3202-G-9003
3202-H-9004	3202-R-8806
3202-H-9004	3202-C-8817*
3202-Y-9125	3202-Z-9126
3202-Y-9125	3202-C-9129*
3202-J-9344	3202-K-9345
3202-J-9344	3202-L-9346*

RS-22-160 Single Axle

3202-Q-8805	3202-B-8816*
3206-X-1532	3206-Z-1534

RC-23-160 Single Axle

3202-Q-8805	3202-G-9003
3202-Y-8683	3202-P-8804

RS-23-160 Single Axle

3202-X-8110	3206-T-1190
3202-Q-8805	3202-B-8816 *
3202-Q-8805	3202-G-9003
3202-H-9004	3202-R-8806
3202-H-9004	3202-C-8817 *
3202-Y-9125	3202-Z-9126
3202-Y-9125	3202-C-9129*
3202-A-9127	3202-B-9128
3202-D-9130*	3202-A-9127
3202-J-9344	3202-L-9346 *
3202-J-9344	3202-K-9345
3202-Y-9489	3202-Z-9490
3202-Y-9489	3202-A-9491 *
3202-L-9502	3202-L-9918
3202-K-9553	3202-A-9647*
3202-E-9573	3202-F-9574
3202-E-9573	3202-G-9575 *

RS-23-161 Single Axle

3202-Q-8805	3202-B-8816 *
3202-Q-8805	3202-G-9003
3202-J-9344	3202-K-9345
3202-J-9344	3202-L-9346 *
3202-Y-9489	3202-Z-9490
3202-Y-9489	3202-A-9491 *
3202-L-9918	3202-L-9502

LEFT HAND	RIGHT HAND
-----------	------------

RS-24-160 Single Axle

3202-Y-8683	3202-P-8804
3202-Y-8683	3202-A-8815

RS-25-160 Single Axle

3202-Q-8805	3202-B-8816*
3202-Q-8805	3202-G-9003
3202-Y-9125	3202-Z-9126
3202-Y-9125	3202-C-9129*
3202-J-9344	3202-K-9345
3202-J-9344	3202-L-9346*

RS-26-160 Single Axle

3202-G-9393	3202-B-8816 *
3202-G-9393	3202-G-9003

RD-20-160 Fwd. axle less pump
RT-40-160 Tandem

3202-R-8806	3202-H-9004
3202-B-8816*	3202-Q-8805
3202-G-9003	3202-Q-8805
3202-Z-9126	3202-Y-9125
3202-C-9129*	3202-Y-9125
3202-K-9345	3202-J-9344
3202-L-9346*	3202-J-9344

RD-23-160 Fwd. axle less pump
RT-46-160 Tandem

3202-R-8806	3202-H-9004
3202-B-8816 *	3202-Q-8805
3202-C-8817 *	3202-H-9004
3202-G-9003	3202-Q-8805
3202-Z-9126	3202-Y-9125
3202-A-9127	3202-D-9130*
3202-C-9129*	3202-Y-9125
3202-K-9345	3202-J-9344
3202-L-9346 *	3202-J-9344
3202-Z-9490	3202-Y-9489
3202-A-9491 *	3202-Y-9489
3202-F-9574	3202-E-9573
3202-G-9575 *	3202-E-9573
3202-J-9916	3202-L-9502

RD-25-160 Fwd. axle less pump
RT-50-160 Tandem

3202-B-8816*	3202-Q-8805
3202-G-9003	3202-Q-8805
3202-Z-9126	3202-Y-9125
3202-C-9129*	3202-Y-9125
3202-K-9345	3202-J-9344
3202-L-9346*	3202-J-9344

* This shaft has longer splines that engage the differential lock.

AXLE SHAFT SETS FOR 160, 161 and 164 SERIES AXLES

LEFT HAND	RIGHT HAND
--------------	---------------

RP-20-160 Fwd. axle with pump
RT-40-160 Tandem

3202-B-8816*	3202-Q-8805
3202-C-8817*	3202-H-9004
3202-G-9003	3202-Q-8805
3202-Z-9126	3202-Y-9125
3202-C-9129*	3202-Y-9125
3202-K-9345	3202-J-9344
3202-L-9346*	3202-J-9344

RP-23-160 Fwd. axle with pump
RT-46-160 Tandem

3202-R-8806	3202-H-9004
3202-B-8816 *	3202-Q-8805
3202-C-8817 *	3202-H-9004
3202-G-9003	3202-Q-8805
3202-Z-9126	3202-Y-9125
3202-A-9127	3202-D-9130*
3202-B-9128	3202-A-9127
3202-C-9129*	3202-Y-9125
3202-K-9345	3202-J-9344
3202-L-9346 *	3202-J-9344
3202-Z-9490	3202-Y-9489
3202-A-9491 *	3202-Y-9489
3202-L-9502	3202-L-9918
3202-F-9574	3202-E-9573
3202-G-9575 *	3202-E-9573
3202-A-9647*	3202-K-9553
3206-T-1190	3202-X-8110

RP-23-164 Fwd. axle with pump
RT-46-164 Tandem

3202-Q-8805	3202-B-8816*
3202-C-8817*	3202-H-9004

RP-25-160 Fwd. axle with pump
RT-50-160 Tandem

3202-R-8806	3202-H-9004
3202-B-8816*	3202-Q-8805
3202-C-8817*	3202-H-9004
3202-G-9003	3202-Q-8805
3202-Z-9126	3202-Y-9125
3202-C-9129*	3202-Y-9125
3202-K-9345	3202-J-9344
3202-L-9346*	3202-J-9344

RR-20-160 Rear axle of
RT-40-160 Tandem

3202-Q-8805	3202-B-8816*
3202-Q-8805	3202-G-9003
3202-H-9004	3202-R-8806
3202-H-9004	3202-C-8817*
3202-Y-9125	3202-Z-9126
3202-Y-9125	3202-C-9129*
3202-J-9344	3202-K-9345
3202-J-9344	3202-L-9346*

LEFT HAND	RIGHT HAND
--------------	---------------

RR-23-160 Rear axle of
RT-46-160 Tandem

3202-Q-8805	3202-B-8816 *
3202-Q-8805	3202-G-9003
3202-X-8110	3206-T-1190
3202-H-9004	3202-R-8806
3202-H-9004	3202-C-8817 *
3202-Y-9125	3202-Z-9126
3202-Y-9125	3202-C-9129*
3202-A-9127	3202-B-9128
3202-D-9130*	3202-A-9127
3202-J-9344	3202-K-9345
3202-J-9344	3202-L-9346 *
3202-Y-9489	3202-Z-9490
3202-Y-9489	3202-A-9491 *
3202-L-9502	3202-J-9916
3202-K-9553	3202-A-9647*
3202-E-9573	3202-F-9574
3202-E-9573	3202-G-9575 *
3202-L-9918	3202-L-9502

RR-23-164 Rear axle of
RT-56-164 Tandem

3202-Q-8805	3202-B-8816*
-------------	--------------

RR-25-160 Rear axle of
RT-50-160 Tandem

3202-Q-8805	3202-B-8816*
3202-H-9004	3202-R-8806
3202-H-9004	3202-C-8817*
3202-Y-9125	3202-Z-9126
3202-Y-9125	3202-C-9129*
3202-J-9344	3202-K-9345
3202-J-9344	3202-L-9346*
3202-Q-8805	3202-G-9003

RD-26-160 Fwd. axle less pump
RT-52-160 Tandem

3202-B-8816 *	3202-G-9393
3202-G-9003	3202-G-9393
3202-Q-9403*	3202-H-9004

RP-26-160 Fwd. axle with pump
RT-52-160 Tandem

3202-B-8816 *	3202-G-9393
3202-G-9003	3202-Q-8805
3202-G-9003	3202-G-9393
3202-Q-9403*	3202-H-9004

RR-26-160 Rear axle of
RT-52-160 Tandem

3202-H-9004	3202-Q-9403*
3202-G-9393	3202-B-8816 *
3202-G-9393	3202-G-9003

* This shaft has longer splines that engage the differential lock.

AXLE SHAFTS



Part Number	Body Dia.	Length	Spline Size	Spline Len.	Flange Dia.	No. of Holes	Hole Size	Bolt Circle	Hole Type
3206-X-1532	2.00"	37.44"	2.35"-46	3.03"	8.38"	8	.73"	7.00"	Taper
3206-Z-1534	2.00"	43.80"	2.35"-46	3.03"	8.38"	8	.73"	7.00"	Taper
3202-J-9344	2.25"	36.57"	2.35"-46	3.03"	8.38"	8	.73"	7.00"	Taper
3202-Y-9125	2.25"	36.57"	2.35"-46	3.03"	8.38"	8	.78"	7.00"	Straight
3202-G-9393	2.25"	37.31"	2.35"-46	3.03"	8.38"	8	.73"	7.00"	Taper
3202-Y-9489	2.25"	37.44"	2.35"-46	3.03"	8.38"	8	.64"	7.00"	Straight
3202-Q-8805	2.25"	37.44"	2.35"-46	3.03"	8.38"	8	.73"	7.00"	Taper
3202-K-9553	2.25"	39.44"	2.35"-46	3.03"	8.38"	8	.73"	7.00"	Taper
3202-A-9127	2.25"	39.44"	2.35"-46	3.03"	8.38"	8	.78"	7.00"	Straight
3202-Y-8683	2.25"	39.59"	2.35"-46	3.03"	8.38"	8	.73"	7.00"	Taper
3202-E-9573	2.25"	40.31"	2.35"-46	3.03"	8.38"	8	.64"	7.00"	Straight
3202-H-9004	2.25"	40.31"	2.35"-46	3.03"	8.38"	8	.73"	7.00"	Taper
3202-P-8804	2.25"	41.57"	2.35"-46	3.03"	8.38"	8	.78"	7.00"	Taper
3202-A-8815	2.25"	41.73"	2.35"-46	9.14"	8.38"	8	.78"	7.00"	Straight
3202-K-9345	2.25"	42.91"	2.35"-46	3.03"	8.38"	8	.73"	7.00"	Taper
3202-Z-9126	2.25"	42.91"	2.35"-46	3.03"	8.38"	8	.78"	7.00"	Straight
3202-L-9346	2.25"	43.07"	2.35"-46	9.14"	8.38"	8	.73"	7.00"	Taper
3202-C-9129	2.25"	43.07"	2.35"-46	9.14"	8.38"	8	.78"	7.00"	Straight
3202-X-8110	2.25"	43.40"	2.35"-46	3.03"	8.38"	8	.73"	7.00"	Taper
3202-Z-9490	2.25"	43.80"	2.35"-46	3.03"	8.38"	8	.64"	7.00"	Straight
3202-G-9003	2.25"	43.80"	2.35"-46	3.03"	8.38"	8	.73"	7.00"	Taper
3202-A-9491	2.25"	43.93"	2.35"-46	9.14"	8.38"	8	.64"	7.00"	Straight
3202-B-8816	2.25"	43.93"	2.35"-46	9.14"	8.38"	8	.73"	7.00"	Taper
3202-B-9128	2.25"	45.74"	2.35"-46	3.03"	8.38"	8	.78"	7.00"	Straight
3202-A-9647	2.25"	45.90"	2.35"-46	9.14"	8.38"	8	.73"	7.00"	Taper
3202-D-9130	2.25"	45.90"	2.35"-46	9.14"	8.38"	8	.78"	7.00"	Straight
3202-F-9574	2.25"	46.61"	2.35"-46	3.03"	8.38"	8	.64"	7.00"	Straight
3202-R-8806	2.25"	46.61"	2.35"-46	3.03"	8.38"	8	.73"	7.00"	Taper
3202-G-9575	2.25"	46.78"	2.35"-46	9.14"	8.38"	8	.64"	7.00"	Straight
3202-C-8817	2.25"	46.78"	2.35"-46	9.14"	8.38"	8	.73"	7.00"	Taper
3202-Q-9403	2.25"	46.90"	2.35"-46	9.14"	8.38"	8	.73"	7.00"	Taper
3206-T-1190	2.25"	49.67"	2.35"-46	3.03"	8.38"	8	.73"	7.00"	Taper
3202-J-9916	2.25"	52.79"	2.35"-46	3.03"	8.38"	8	.73"	7.00"	Taper
3202-L-9918	2.25"	52.92"	2.35"-46	9.14"	8.38"	8	.73"	7.00"	Taper

ROUND BEARING TYPE YOKES



Axle Model (Location)	Center to End	Spline Length	Hub Dia.	Bearing Cap Diameter	Yoke Dimension Across Ears	Spline Size Dia. - No. Teeth	Part Number	Production Part Number
Forward Input/ Rear Axle	4.94"	2.32"	3.25"	1.88"	5.31"	2.38"-46	16NYS38-8A	A-3260-T-1034
	6.19"			1.88"	5.31"		16NYS38-12A	A-3260-G-1125
	5.38"			1.94"	6.09"		17N-4-7181X	A-3260-U-359
	6.50"			1.94"	6.09"		17N-4-7771X	A-3260-R-1058
	5.06"			1.94"	7.00"		176NYS38-14A	A-3260-V-360
	5.16"			1.94"	7.55"		18N-4-3731X	A-3260-C-1147
Forward Output/ Rear Axle	5.54"	2.31"	3.00"	1.88"	5.31"	2.00"-39	16N-4-6271	3260-G-111
	6.22"			1.88"	5.31"		16N-4-6241	3260-H-112
	5.16"			1.94"	6.09"		17NYS32-100	3260-Q-121
	6.25"			1.94"	6.09"		17NYS32-99	3260-P-120
Rear Input/ Rear Axle and Single Axle Applications	4.94"	2.32"	3.25"	1.88"	5.31"	2.38"-46	16NYS38-8A	A-3260-T-1034
	6.19"			1.88"	5.31"		16NYS38-12A	A-3260-G-1125
	5.38"			1.94"	6.09"		17N-4-7181X	A-3260-U-359
	6.50"			1.94"	6.09"		17NYS38-38A	A-3260-R-1058
	5.06"			1.94"	7.00"		176NYS38-14A	A-3260-V-360
	5.16"			1.94"	7.55"		18NYS38-27A	A-3260-C-1147

For additional: Parts Information
 Cross Reference
 Production Bills of Material

visit our online catalog at: XpresswayPlus.ArvinMeritor.com

WING BEARING TYPE YOKES



Axle Model (Location)	Face to End	Spline Length	Hub Dia.	Pilot Diameter	Keyway Width	Spline Size Dia. - No. Teeth	Hole Type	Part Number	Production Part Number
Forward Input/ Rear Axle	4.25"	2.32"	3.25"	5.84"	.63"	2.38"-46	TH	72NYS38-26A	A-3260-B-1146
	4.25"	2.32"	3.25"	8.13"	.63"	2.38"-46	TH	82NYS38-31A	A-3260-H-1308
	4.22"	2.32"	3.25"	8.25"	.63"	2.38"-46	TH	92NYS38-73A	A-3260-K-1129
Forward Output/ Rear Axle	3.81"	2.31"	3.00"	5.84"	.63"	2.00"-39	TH	72NYS32-244	3260-S-123
	4.44"	2.31"	3.00"	8.25"	.63"	2.00"-39	DR	92NYS32-26	3260-B-132
Rear Input/ Rear Axle and Single Axle Applications	4.25"	2.32"	3.25"	5.84"	.63"	2.38"-46	TH	72NYS38-26A	A-3260-B-1146
	4.25"	2.32"	3.25"	5.84"	.63"	2.38"-46	DR	72NYS38-24A	A-3260-Z-1144
	4.25"	2.32"	3.25"	8.13"	.63"	2.38"-46	TH	82NYS38-31A	A-3260-H-1308
	4.22"	2.32"	3.25"	8.25"	.63"	2.38"-46	TH	92NYS38-73A	A-3260-K-1129



MERITOR

an **ArvinMeritor** brand

EASY SERVICE (STRAP) TYPE YOKES



Axle Model (Location)	Center to End	Spline Length	Hub Dia.	Bearing Cap Diameter	Distance Between Nibbs	Spline Size Dia. - No. Teeth	Hole Type	Part Number	Production Part Number
Forward Input/ Rear Axle	5.38"	2.32"	3.25"	1.94"	6.19"	2.38"-46	TH	17N-4-7181-1X	A-3260-G-1229
	5.06"			1.94"	7.09"		TH	176TYS38-27A	A-3260-P-1264
	5.16"			1.93"	7.64"		TH	18N-4-3731-1X	A-3260-L-1260
Forward Output/ Rear Axle	6.22"	2.31"	3.00"	1.88"	5.31"	2.00"-39	TH	16TYS32-76	3260-D-1668
	6.25"			1.94"	6.19"		TH	17TYS32-99	3260-A-1535
	5.16"			1.94"	6.19"		TH	17N-4-7621-1	3260-R-1292
Rear Input/ Rear Axle and Single Axle Applications	4.94"	2.32"	3.25"	1.88"	5.31"	2.38"-46	TH	16N-4-7341-1X	A-3260-L-1234
	5.38"			1.94"	6.19"		TH	17TYS38-76A	A-3260-G-1229
	5.06"			1.94"	7.09"		TH	176TYS38-27A	A-3260-P-1264
	5.16"			1.93"	7.64"		TH	18TYS38-27A	A-3260-L-1260



If you detect any **errors** in this catalog, please let us know.

We want the information to be as accurate as possible; we appreciate your help in making it so.

Please e-mail any comments/suggestions/corrections to us at: catalogfeedback@arvinmeritor.com

or mail to: ArvinMeritor
attn: Catalog Dept.
7975 Dixie Highway
Florence, KY 41042

COMPANION FLANGES



Axle Model (Location)	Face to End	Spline Length	Hub Dia.	Pilot Dia. M=Male F=Female	Flange Dia.	Hole Size	Bolt Circle Dia.	Spline Size Dia. - No. Teeth	Part Number	Production Part Number
Forward Input/ Rear Axle	3.88"	2.32"	3.25"	F-7.75"	8.00"	.38"	7.25"	2.38"-46	5WCS38-18A	A-3280-W-8265
Rear Input/ Rear Axle and Single Axle Applications	3.56"	2.32"	3.25"	F-7.75"	8.00"	.44"	7.25"	2.38"-46	5WCS38-23A2	A2-3260-R-1240
	3.88"					.38"			5WCS38-18A	A-3280-W-8265

XpresswayPlus.ArvinMeritor.com



XpresswayPlus.ArvinMeritor.com
For all of your parts-ordering needs

Don't forget about using *XpresswayPlus* for:

- Ordering parts online
- Order status
- Price and availability
- Invoice Lookup
- Parts Catalog
- Online e-mail or phone numbers for Customer Service, Information Services, Marketing, Catalog, and eSupport
- Reference Library
- The Company Store
- Literature
- Dealer/Distributor locator

XpresswayPlus is easy to use, can reduce phone calls, and save you valuable time.

AXLE MODEL TO CARRIER TO KIT CROSS REFERENCE

AXLE MODEL	BASE CARRIER	KIT DESCRIPTION	KIT NUMBER
Single Axle	3200-C-1511 Standard	Pinion bearing cage shims	KIT 1592
RC-23-160	3200-C-1511 Diff. lock	Pinion bearing spacers	KIT 1593
RS-23-160		Ring gear to case fastener kit, prior to 4/88	KIT 2317
RS-23-161		Main diff. nest kit with spider	KIT 2318
RS-24-160		Main diff. nest kit less spider	KIT 2341
RS-25-160		Main diff. lock actuator kit (minor)	KIT 2406
RS-26-160		Main diff. lock actuator	KIT 2414
		Ring gear to case fasteners after 4/88	KIT 2426
		Diff. case assembly kit	KIT 2796
		Main diff. lock piston kit	KIT 2614
		Diff. case and gearset upgrade	KIT 2655-391
		Diff. case and gearset upgrade	KIT 2655-410
		Diff. case and gearset upgrade	KIT 2655-430
		Diff. case and gearset upgrade	KIT 2655-456
		Replaces A2-3200-C-1511 fast ratios, less diff. lock.	KIT 2657
		Replaces A2-3200-C-1511 mid range ratios, less diff. lock.	KIT 2657A
		Replaces A2-3200-C-1511 std. range ratios, less diff. lock.	KIT 2657B
		Replaces A2-3200-C-1511 fast ratios, with diff. lock.	KIT 2658
		Replaces A2-3200-C-1511 mid range ratios, with diff. lock.	KIT 2658A
		Replaces A2-3200-C-1511 std. ratios, with diff. lock.	KIT 2658B
		Lock pin kit (non-ABS carriers only)	KIT 4284
		Bearing and seal kit	KIT 4415
		Major overhaul kit	KIT RR23160
	3200-Z-1560 Standard	Pinion bearing cage shims	KIT 1592
	3200-Z-1560 Diff. Lock	Pinion bearing spacers	KIT 1593
	3200-Z-1560 NoSpin diff.	Ring gear to case fastener kit, prior to 4/88	KIT 2317
		Main diff. nest kit with spider *	KIT 2318
		Main diff. nest kit less spider *	KIT 2341
		Main diff. lock actuator kit (minor)	KIT 2406
		Ring gear to case fasteners after 4/88	KIT 2426
		Diff. case assembly kit	KIT 2796
		Main diff. lock piston kit	KIT 2614
		Diff. case and gearset upgrade	KIT 2468-391
		Diff. case and gearset upgrade	KIT 2468-410
		Diff. case and gearset upgrade	KIT 2468-430
		Diff. case and gearset upgrade	KIT 2468-456
		Replaces A2-3200-Z-1560 fast ratios, less diff. lock.	KIT 2642
		Replaces A2-3200-Z-1560 mid range ratios, less diff. lock.	KIT 2642A
		Replaces A2-3200-Z-1560 std. ratios, less diff. lock.	KIT 2642B
		Replaces A2-3200-Z-1560 fast ratios, with diff. lock.	KIT 2643
		Replaces A2-3200-Z-1560 mid range ratios, with diff. lock.	KIT 2643A
		Replaces A2-3200-Z-1560 std. ratios, with diff. lock.	KIT 2643B
		Lock pin kit (non-ABS carriers only)	KIT 4284
		Bearing and seal kit	KIT 4415
		Major overhaul kit	KIT RR23160
	3200-T-1658 Standard	Pinion bearing cage shims	KIT 1592
	3200-T-1658 NoSpin diff.	Pinion bearing spacers	KIT 1593
		Ring gear to case fastener kit, prior to 4/88	KIT 2317
		Main diff. nest kit with spider *	KIT 2318
		Main diff. nest kit less spider *	KIT 2341
		Ring gear to case fasteners after 4/88	KIT 2426
		Diff. case assembly kit	KIT 2796
		Replaces A2-3200-T-1658 fast ratios, less diff. lock.	KIT 2642
		Replaces A2-3200-T-1658 mid range ratios, less diff. lock.	KIT 2642A
		Replaces A2-3200-T-1658 std. range ratios, less diff. lock.	KIT 2642B
		Lock pin kit (non-ABS carriers only)	KIT 4284
		Bearing and seal kit	KIT 4415
		Major overhaul kit	KIT RR23160

* Diff. nest kit not required with NoSpin.

AXLE MODEL TO CARRIER TO KIT CROSS REFERENCE

AXLE MODEL	BASE CARRIER	KIT DESCRIPTION	KIT NUMBER
Single Axle	3200-R-1708 Diff. lock	Pinion bearing cage shims	KIT 1592
RC-23-160	3200-C-1823 Diff. lock	Pinion bearing spacers	KIT 1593
RS-23-160	3200-T-1892 Diff. lock	Main diff. nest kit w ith spider	KIT 2318
RS-23-161	3200-D-1928 Diff. lock	Main diff. nest kit less spider	KIT 2341
RS-24-160		Main diff. lock actuator kit (minor) (all except 3200-T-1892)	KIT 2406
RS-25-160		Main diff. lock actuator kit (minor) (3200-T-1892)	KIT 2750
RS-26-160		Ring gear to case fasteners after 4/88	KIT 2426
		Diff. case assembly kit	KIT 2796
		Main diff. lock piston kit (all except 3200-T-1892)	KIT 2614
		Main diff. lock piston kit (3200-T-1892)	KIT 2691
		Main diff. lock actuator kit (all except 3200-T-1892)	KIT 2615
		Main diff. lock actuator kit (3200-T-1892)	KIT 2698
		Replaces A2-3200-R-1708	KIT 2659
		Lock pin kit (non-ABS carriers only)	KIT 4284
		Bearing and seal kit	KIT 4428
		Main diff. lock kit (3200-T-1892, 3200-D-1928)	KIT 2698
		Major overhaul kit	KIT RR23160B
		Replaces A2-3200-C-1823	KIT 2762
	3200-P-1706 Standard	Pinion bearing cage shims	KIT 1592
	3200-H-1854 Standard	Pinion bearing spacers	KIT 1593
	3200-J-1856 Standard	Main diff. nest kit w ith spider *	KIT 2318
		Main diff. nest kit less spider *	KIT 2341
	3200-P-1706 NoSpin diff.	Ring gear to case fasteners after 4/88	KIT 2426
	3200-A-1821 NoSpin diff.	Diff. case assembly kit	KIT 2796
		Lock pin kit (non-ABS carriers only)	KIT 4284
		Bearing and seal kit	KIT 4426
		Major overhaul kit	KIT RR23160A
	3200-V-1712 Standard	Pinion bearing cage shims	KIT 1592
	3200-Y-1897 Standard	Pinion bearing spacers	KIT 1593
	3200-E-1929 Standard	Main diff. nest kit w ith spider *	KIT 2318
		Main diff. nest kit less spider *	KIT 2341
	3200-V-1712 Diff. lock	Ring gear to case fasteners after 4/88	KIT 2426
	3200-Y-1897 Diff. lock	Diff. case assembly kit	KIT 2796
	3200-E-1929 Diff. lock	Main diff. lock piston kit (all except 3200-Y-1897,3200-E-1929)	KIT 2614
		Main diff. lock actuator (all except 3200-Y-1897,3200-E-1929)	KIT 2615
	3200-V-1712 NoSpin diff.	Main diff. lock kit (3200-Y-1897,3200-E-1929)	KIT 2698
	3200-E-1825 NoSpin diff.	Lock pin kit (non-ABS carriers only)	KIT 4284
		Bearing and seal kit	KIT 4428
		Major overhaul kit	KIT RR23160B
	3200-V-1660 Diff. lock	Pinion bearing cage shims	KIT 1592
		Pinion bearing spacers	KIT 1593
		Ring gear to case fastener kit, prior to 4/88	KIT 2317
		Main diff. nest kit w ith spider	KIT 2318
		Main diff. nest kit less spider	KIT 2341
		Main diff. lock actuator kit (minor)	KIT 2406
		Main diff. lock actuator kit	KIT 2414
		Ring gear to case fasteners after 4/88	KIT 2426
		Diff. case assembly kit	KIT 2796
		Main diff. lock piston kit	KIT 2614
		Replaces A2-3200-Z-1560 fast ratios, w ith diff. lock.	KIT 2643
		Replaces A2-3200-Z-1560 mid range ratios, w ith diff. lock.	KIT 2643A
		Replaces A2-3200-Z-1560 std. ratios, w ith diff. lock.	KIT 2643B
		Lock pin kit (non-ABS carriers only)	KIT 4284
		Bearing and seal kit	KIT 4415
		Major overhaul kit	KIT RR23160

* Diff. nest kit not required w ith NoSpin.

AXLE MODEL TO CARRIER TO KIT CROSS REFERENCE

AXLE MODEL	BASE CARRIER	KIT DESCRIPTION	KIT NUMBER
Front RD-20-160 RD-23-160 RD-23-164 RD-26-160 RD-25-160	3200-J-1648 Standard 3200-J-1648 NoSpin diff.	Thru-shaft bearing preload spacers	KIT 576
		Ring gear to case fastener kit, prior to 4/88	KIT 2317
		Main diff. nest kit with spider *	KIT 2318
		Main diff. nest kit less spider *	KIT 2341
		Pinion bearing spacers	KIT 2397
		I.A.D nest with spider	KIT 2424
		Ring gear to case fasteners after 4/88	KIT 2426
		Input and pinion shims	KIT 2429
		Helical gear kit	KIT 2483
		I.A.D. nest less spider	KIT 2489
	3200-M-1703 Standard 3200-M-1703 NoSpin diff.	Thru-shaft bearing preload spacers	KIT 576
		Main diff. nest kit with spider *	KIT 2318
		Main diff. nest kit less spider *	KIT 2341
		Pinion bearing spacers	KIT 2397
		I.A.D nest with spider	KIT 2424
		Ring gear to case fasteners after 4/88	KIT 2426
		Input and pinion shims	KIT 2429
		Helical gear kit	KIT 2483
		I.A.D. nest less spider	KIT 2489
		Replaces A2-3200-M-1703	KIT 2618
3200-X-1818 Standard 3200-K-1857 Standard 3200-Q-1837 Standard 3200-J-2116 Standard 3200-X-1818 NoSpin diff. 3200-J-2116 NoSpin diff.	Thru-shaft bearing preload spacers	KIT 576	
	Main diff. nest kit with spider *	KIT 2318	
	Main diff. nest kit less spider *	KIT 2341	
	Pinion bearing spacers	KIT 2397	
	I.A.D nest with spider	KIT 2424	
	Ring gear to case fasteners after 4/88	KIT 2426	
	Input and pinion shims	KIT 2429	
	Helical gear kit	KIT 2483	
	I.A.D. nest less spider	KIT 2489	
	Output nut and washer upgrade	KIT 2637	
	Input shaft nut and washer upgrade	KIT 2638	
	Lock pin kit (non-ABS carriers only)	KIT 4284	
	Bearing and seal kit	KIT 4422	
	Overhaul kit	KIT RP23160A	
	Thru-shaft bearing preload spacers	KIT 576	
	Main diff. nest kit with spider *	KIT 2318	
	Main diff. nest kit less spider *	KIT 2341	
	Pinion bearing spacers	KIT 2397	
I.A.D nest with spider	KIT 2424		
Ring gear to case fasteners after 4/88	KIT 2426		
Input and pinion shims	KIT 2429		
Helical gear kit	KIT 2483		
I.A.D. nest less spider	KIT 2489		
Output nut and washer upgrade	KIT 2637		
Input shaft nut and washer upgrade	KIT 2638		
Lock pin kit (non-ABS carriers only)	KIT 4284		
Tapered dowel Kit (3200-X-1818)	KIT 4288		
Bearing and seal kit	KIT 4422		
Overhaul kit	KIT RP23160A		
Front RD-20-160 RD-23-160 RD-23-164 RD-26-160 RD-25-160	3200-W-1713 Diff. lock	Thru-shaft bearing preload spacers	KIT 576
		Main diff. nest kit with spider	KIT 2318
		Main diff. nest kit less spider	KIT 2341
		Pinion bearing spacers	KIT 2397
		Main diff. lock actuator kit (minor)	KIT 2406
		I.A.D nest with spider	KIT 2424

* Diff. nest kit not required with NoSpin.

AXLE MODEL TO CARRIER TO KIT CROSS REFERENCE

AXLE MODEL	BASE CARRIER	KIT DESCRIPTION	KIT NUMBER
Front RD-20-160 RD-23-160 RD-23-164 RD-26-160 RD-25-160 (Cont.)	3200-W-1713 Diff. lock (Continued)	Ring gear to case fasteners after 4/88	KIT 2426
		Input and pinion shims	KIT 2429
		Helical gear kit	KIT 2483
		I.A.D. nest less spider	KIT 2489
		Main diff. lock piston kit	KIT 2614
		Main diff. lock actuator kit	KIT 2615
		Output nut and washer upgrade	KIT 2637
		Input shaft nut and washer upgrade	KIT 2638
		Lock pin kit (non-ABS carriers only)	KIT 4284
		Bearing and seal kit	KIT 4423
	Overhaul kit	KIT RP23160B	
3200-Y-1819 Diff. lock 3200-W-1895 Diff. lock 3200-L-2118 Diff. lock		Thru-shaft bearing preload spacers	KIT 576
		Main diff. nest kit with spider	KIT 2318
		Main diff. nest kit less spider	KIT 2341
		Pinion bearing spacers	KIT 2397
		Main diff. lock actuator kit (minor)	KIT 2406
		I.A.D nest with spider	KIT 2424
		Ring gear to case fasteners after 4/88	KIT 2426
		Input and pinion shims	KIT 2429
		Helical gear kit	KIT 2483
		I.A.D. nest less spider	KIT 2489
		Main diff. lock piston kit (all except 3200-W-1895)	KIT 2614
		Main diff. lock actuator kit (all except 3200-W-1895)	KIT 2615
		Output nut and washer upgrade	KIT 2637
		Input shaft nut and washer upgrade	KIT 2638
		Main diff. lock piston kit (3200-W-1895)	KIT 2691
		Lock pin kit (non-ABS carriers only)	KIT 4284
		Tapered dowel kit (3200-L-2118)	KIT 4288
		Bearing and seal kit	KIT 4423
		Overhaul kit	KIT RP23160B
		Replaces A2-3200-Y-1819	KIT 2764
3200-P-1628 Standard 3200-P-1628 NoSpin diff. 3200-P-1628 Pump 3200-P-1628 Pump w/diff. lock 3200-P-1628 Pump w/NoSpin		Thru-shaft bearing preload spacers	KIT 576
		Ring gear to case fastener kit, prior to 4/88	KIT 2317
		Main diff. nest kit with spider *	KIT 2318
		Main diff. nest kit less spider *	KIT 2341
		Pinion bearing spacers	KIT 2397
		Main diff. lock actuator kit (minor)	KIT 2406
		Main diff. lock actuator kit	KIT 2414
		I.A.D nest with spider	KIT 2424
		Ring gear to case fasteners after 4/88	KIT 2426
		Input and pinion shims	KIT 2429
		Helical gear kit	KIT 2483
		I.A.D. nest less spider	KIT 2489
		Main diff. lock piston kit	KIT 2614
		Input shaft and pump upgrade kit	KIT 2624
		Output nut and washer upgrade	KIT 2637
		Input shaft nut and washer upgrade	KIT 2638
		Replaces A2-3200-P-1628, fast ratios, with diff. lock	KIT 2640
		Replaces A2-3200-P-1628, mid-range ratios, with diff. lock	KIT 2640A
		Replaces A2-3200-P-1628, std. ratios, with diff. lock	KIT 2640B
		Replaces A2-3200-P-1628, fast ratios, less diff. lock	KIT 2641
		Replaces A2-3200-P-1628, mid-range ratios, less diff. lock	KIT 2641A
		Replaces A2-3200-P-1628, std. ratios, less diff. lock	KIT 2641B
		Lock pin kit (non-ABS carriers only)	KIT 4284
Bearing and seal kit	KIT 4420		
Overhaul kit	KIT RP23160		

* Diff. nest kit not required with NoSpin.

AXLE MODEL TO CARRIER TO KIT CROSS REFERENCE

AXLE MODEL	BASE CARRIER	KIT DESCRIPTION	KIT NUMBER
Front	3200-K-1701 Pump	Thru-shaft bearing preload spacers	KIT 576
RP-20-160	3200-K-1701 Pump w/diff. lock	Main diff. nest kit with spider *	KIT 2318
RP-23-160	3200-K-1701 Pump w/NoSpin	Main diff. nest kit less spider *	KIT 2341
RP-23-164		Pinion bearing spacers	KIT 2397
RP-25-160		Main diff. lock actuator kit (minor)	KIT 2406
RP-26-160		I.A.D nest with spider	KIT 2424
		Ring gear to case fasteners after 4/88	KIT 2426
		Input and pinion shims	KIT 2429
		Helical gear kit	KIT 2483
		I.A.D. nest less spider	KIT 2489
		Main diff. lock piston kit	KIT 2614
		Main diff. lock actuator kit	KIT 2615
		Replaces A2-3200-K-1701	KIT 2616
		Output nut and washer upgrade	KIT 2637
		Input shaft nut and washer upgrade	KIT 2638
		Lock pin kit (non-ABS carriers only)	KIT 4284
		Bearing and seal kit	KIT 4423
		Overhaul kit	KIT RP23160B
	3200-Z-1820 Pump	Thru-shaft bearing preload spacers	KIT 576
	3200-V-1894 Pump	Main diff. nest kit with spider *	KIT 2318
	3200-K-2117 Pump	Main diff. nest kit less spider *	KIT 2341
		Pinion bearing spacers	KIT 2397
	3200-Z-1820 Pump w/diff. lock	Main diff. lock actuator kit (minor) (all except 3200-V-1894)	KIT 2406
	3200-V-1894 Pump w/diff. lock	Main diff. lock actuator kit (minor) (3200-V-1894)	KIT 2750
	3200-K-2117 Pump w/diff. lock	I.A.D nest with spider	KIT 2424
		Ring gear to case fasteners after 4/88	KIT 2426
	3200-Z-1820 Pump w/NoSpin	Input and pinion shims	KIT 2429
	3200-V-1894 Pump w/NoSpin	Helical gear kit	KIT 2483
	3200-K-2117 Pump w/NoSpin	I.A.D. nest less spider	KIT 2489
		Main diff. lock piston kit (all except 3200-V-1894)	KIT 2614
		Main diff. lock piston kit (3200-V-1894)	KIT 2691
		Main diff. lock actuator kit (all except 3200-V-1894)	KIT 2615
		Main diff. lock actuator kit (3200-V-1894)	KIT 2698
		Output nut and washer upgrade	KIT 2637
		Input shaft nut and washer upgrade	KIT 2638
		Lock pin kit (non-ABS carriers only)	KIT 4284
		Tapered dowel kit (3200-K-2117)	KIT 4288
		Bearing and seal kit	KIT 4423
		Overhaul kit	KIT RP23160B
		Replaces A2-3200-Z-1820 less diff. lock	KIT 2766
		Replaces A2-3200-Z-1820 with diff. lock	KIT 2763
Rear	All	Use the carriers and kits in the RS-23-160 section	---
RR-20-160			
RR-23-160			
RR-23-164			
RR-25-160			
RR-26-160			

* Diff. nest kit not required with NoSpin.

SERVICE KITS

KIT RP23160

ITEM	PART NUMBER	QTY.	DESCRIPTION	REMARKS
1	40-X-1145	1	Nut	Forward-rear carriers with I.A.D. and without main diff. lock. RP-23-160, RP-23-164, RP-26-160 3200-J-1648, 3200-P-1628
2	KIT 2318	1	Main diff. kit with spider	
3	KIT 2424	1	IAD Kit with Spider	
4	KIT 2429	1	Shim Kit	
5	KIT 2637	1	Input Nut and Washer Kit	
6	40-X-1233	1	Pinion Nut	
7	1229-N-1730	1	Pinion Washer	
8	KIT 2397	1	Spacer Kit	
9	KIT 4420	1	Bearing & Seal Kit	

KIT RP23160A

ITEM	PART NUMBER	QTY.	DESCRIPTION	REMARKS
1	40-X-1145	1	Nut	Forward-rear carriers with I.A.D. and without main diff. lock. RD-23-160, RD-23-164, RD-26-160 3200-M-1703, 3200-Q-1837, 3200-X-1818, 3200-J-2116
2	40-X-1233	1	Lock Nut	
3	1229-N-1730	1	Washer	
4	KIT 2318	1	Main diff. kit with spider	
5	KIT 2424	1	IAD Kit with Spider	
6	KIT 2429	1	Shim Kit	
7	KIT 2637	1	Input Nut and Washer Kit	
8	KIT 2397	1	Spacer Kit	
9	KIT 4422	1	Bearing & Seal Kit	

KIT RP23160B

ITEM	PART NUMBER	QTY.	DESCRIPTION	REMARKS
1	40-X-1145	1	Nut	Forward-rear carriers with I.A.D. and with main diff. lock. RD-23-160, RD-23-164, RD-26-160, RP-23-160, RP-23-164, RP-26-160 3200-J-1908, 3200-K-1701, 3200-K-1909, 3200-V-1894, 3200-W-1713, 3200-W-1895, 3200-Y-1819, 3200-Z-1820
2	40-X-1233	1	Lock Nut	
3	1229-N-1730	1	Washer	
4	KIT 2318	1	Main diff. kit with spider	
5	KIT 2397	1	Spacer Kit	
6	KIT 2424	1	IAD Kit with Spider	
7	KIT 2429	1	Shim Kit	
8	KIT 2637	1	Input Nut and Washer Kit	
9	KIT 4423	1	Bearing & Seal Kit	

KIT RR23160

ITEM	PART NUMBER	QTY.	DESCRIPTION	REMARKS
1	KIT 1592	1	Shim Kit	Single and rear-rear carriers without main diff. lock. RS-23-160, RS-23-161, RS-25-160, RS-26-160 3200-C-1511, 3200-T-1658, 3200-V-1660, 3200-Z-1560
2	KIT 1593	1	Spacer Kit	
3	KIT 2318	1	Main diff. kit with spider	
4	40-X-1233	1	Pinion Nut	
5	1229-N-1730	1	Pinion Washer	
6	KIT 4415	1	Bearing & Seal Kit	

KIT RR23160A

ITEM	PART NUMBER	QTY.	DESCRIPTION	REMARKS
1	40-X-1233	1	Lock Nut	Single and rear-rear carriers without main diff. lock. RS-23-160, RS-23-161, RS-25-160, RS-26-160 3200-A-1821, 3200-H-1854, 3200-J-1856, 3200-P-1706
2	1229-N-1730	1	Washer	
3	KIT 1592	1	Shim Kit	
4	KIT 1593	1	Spacer Kit	
5	KIT 2318	1	Main diff. kit with spider	
6	KIT 4426	1	Bearing & Seal Kit	

KIT RR23160B

ITEM	PART NUMBER	QTY.	DESCRIPTION	REMARKS
1	40-X-1233	1	Lock Nut	Single and rear-rear carriers with diff. lock. RS-23-160, RS-23-161, RS-25-160, RS-26-160 3200-C-1823, 3200-D-1928, 3200-E-1825, 3200-E-1929, 3200-R-1708, 3200-T-1892, 3200-V-1712, 3200-Y-1897
2	1229-W-4521	1	Washer	
3	KIT 1592	1	Shim Kit	
4	KIT 1593	1	Spacer Kit	
5	KIT 2318	1	Main diff. kit with spider	
6	KIT 4428	1	Bearing & Seal Kit	

SERVICE KITS

KIT 576

ITEM	PART NUMBER	QTY.	DESCRIPTION	REMARKS
1	1229-P-2590	1	Snap Ring - 3.94mm/.155 in.	Output shaft snap ring kit RD-23-160, RD-23-164, RD-26-160, RP-23-160, RP-23-164, RP-26-160
2	1229-Q-2591	1	Snap Ring - 4.01mm/.158 in.	
3	1229-R-2592	1	Snap Ring - 4.09mm/.161 in.	
4	1229-S-2593	1	Snap Ring - 4.17mm/.164 in.	
5	1229-T-2594	1	Snap Ring - 4.24mm/.167 in.	
6	1229-U-2595	1	Snap Ring - 4.32mm/.170 in.	
7	1229-V-2596	1	Snap Ring - 4.39mm/.173 in.	
8	1229-W-2597	1	Snap Ring - 4.47mm/.176 in.	
9	1229-X-2598	1	Snap Ring - 4.55mm/.179 in.	
10	1229-Y-2599	1	Snap Ring - 4.62mm/.182 in.	

KIT 1592

ITEM	PART NUMBER	QTY.	DESCRIPTION	REMARKS
1	2803-Y-2755	4	0.002 in./0.050 mm Shim	RS-23-160, RS-23-161, RS-25-160, RS-26-160
2	2803-Z-2756	2	0.005 in./0.125 mm Shim	
3	2803-A-2757	4	0.008 in./0.200 mm Shim	
4	2803-B-2758	1	0.020 in./0.500 mm Shim	

KIT 1593

ITEM	PART NUMBER	QTY.	DESCRIPTION	REMARKS
1	2803-D-2500	2	.250 in./6.35 mm Spacer	Pinion bearing spacers RR-23-160, RS-23-160, RS-23-161, RS-25-160, RS-26-160 3200-A-1821, 3200-A-1899, 3200-C-1511, 3200-C-1823, 3200-C-1831, 3200-D-1928, 3200-E-1825, 3200-E-1929, 3200-H-1854, 3200-J-1752, 3200-J-1804, 3200-J-1856, 3200-K-1753, 3200-P-1706, 3200-R-1708, 3200-S-1839, 3200-T-1658, 3200-T-1892, 3200-U-1399, 3200-V-1660, 3200-V-1712, 3200-W-1791, 3200-Y-1897, 3200-Z-1560
2	2803-E-2501	2	.251 in./6.38 mm Spacer	
3	2803-F-2502	2	.252 in./6.40 mm Spacer	
4	2803-N-2510	2	.253 in./6.45 mm Spacer	
5	2803-G-2503	2	.254 in./6.45 mm Spacer	
6	2803-H-2504	2	.256 in./6.50 mm Spacer	
7	2803-J-2506	2	.260 in./6.60 mm Spacer	
8	2803-K-2507	2	.261 in./6.63 mm Spacer	
9	2803-L-2508	2	.262 in./6.65 mm Spacer	
10	2803-M-2509	2	.263 in./6.68 mm Spacer	

KIT 2317

ITEM	PART NUMBER	QTY.	DESCRIPTION	REMARKS
1	41-X-1216	12	Capscrew	Gear to case bolt kit (17.0 mm bolts prior to 4-88) RD-23-160, RD-23-164, RD-26-160, RP-23-160, RP-23-164, RP-26-160, RR-23-160, RR-23-164, RR-26-160, RS-23-160, RS-25-160, RS-26-160
2	1229-U-1503	12	Washer	
3	40-X-1182	12	Lock Nut	

KIT 2318

ITEM	PART NUMBER	QTY.	DESCRIPTION	REMARKS
1	2233-M-1001	4	Differential Pinion, Finished	Main diff. kit with spider. RS-23-160, RS-23-161, RS-25-160
2	2234-C-1069	2	Differential Side Gear, Finished	
3	3278-W-335	1	Differential Spider	
4	1229-L-3002	2	Side Gear Thrust Washer	
5	1229-K-3001	4	Differential Pinion Washer	

KIT 2341

ITEM	PART NUMBER	QTY.	DESCRIPTION	REMARKS
1	1229-L-3002	2	Side Gear Thrust Washer	Main diff. kit less spider. RS-23-160, RS-23-161, RS-25-160
2	2234-C-1069	2	Differential Side Gear, Finished	
3	2233-M-1001	4	Differential Pinion, Finished	
4	1229-K-3001	4	Differential Pinion Washer	

SERVICE KITS

KIT 2397

ITEM	PART NUMBER	QTY.	DESCRIPTION	REMARKS
1	2203-V-9824	2	.451 in./11.45 mm Spacer	Pinion bearing spacers RD-23-160, RD-23-164, RD-26-160, RP-23-160, RP-23-164, RP-26-160
2	2203-W-9825	2	.452 in./11.48 mm Spacer	
3	2203-X-9826	2	.453 in./11.50 mm Spacer	
4	2203-Y-9827	2	.454 in./11.53 mm Spacer	
5	2203-Z-9828	2	.455 in./11.55 mm Spacer	
6	2203-A-9829	2	.459 in./11.65 mm Spacer	
7	2203-B-9830	2	.463 in./11.75 mm Spacer	
8	2203-C-9831	2	.467 in./11.85 mm Spacer	
9	2203-D-9832	2	.470 in./11.95 mm Spacer	
10	2203-E-9833	2	.474 in./12.05 mm Spacer	
11	2203-F-9834	2	.478 in./12.15 mm Spacer	
12	2203-G-9835	2	.482 in./12.25 mm Spacer	
13	2203-H-9836	2	.483 in./12.28 mm Spacer	
14	2203-J-9838	2	.484 in./12.30 mm Spacer	
15	2203-K-9839	2	.485 in./12.33 mm Spacer	
16	2203-L-9840	2	.486 in./12.35 mm Spacer	

KIT 2406

ITEM	PART NUMBER	QTY.	DESCRIPTION	REMARKS
1	3196-F-32	1	Air Cylinder tube	Bolt-on shifter. RD-23-160, RD-23-164, RD-26-160, RP-23-160, RP-23-164, RP-26-160, RS-23-160, RS-23-161, RS-25-160, RS-26-160 3200-C-1511, 3200-Z-1560, 3200-P-1628, 3200-V-1660, 3200-K-1701, 3200-R-1708, 3200-V-1712, 3200-W-1713, 3200-Y-1819, 3200-C-1823, 3200-E-1825
2	2230-N-170	1	Piston	
3	5-X-1153	1	O-Ring	
4	2208-H-944	1	Gasket	
5	41-X-1333	1	Capscrew	
6	41-X-1364	4	Capscrew	
7	MWA-506	4	Washer	
8	42-X-1027	1	Washer	

KIT 2414

ITEM	PART NUMBER	QTY.	DESCRIPTION	REMARKS
1	3266-F-1020	1	Cover	Services carriers with main diff. lock, prior to 11/93. RS-23-160, RS-23-161, RS-25-160, RS-26-160 3200-C-1511, 3200-P-1628, 3200-V-1660
2	MWA-506	4	Washer	
3	2208-L-1000	1	Gasket	
4	MS-210016-1	1	Capscrew	
5	41-X-1364	4	Capscrew	
6	2208-H-944	1	Gasket	
7	3196-F-32	1	Air Cylinder tube	
8	5-X-1153	1	O-Ring	
9	2230-N-170	1	Piston	
10	42-X-1027	1	Washer	
11	2244-Y-51	1	Shift Shaft	
12	43-X-1006	1	Shift Shaft Pin	
13	2258-L-714	1	Spring	
14	43-X-1007	2	Shift Fork Pin	
15	41-X-1333	1	Capscrew	
16	3296-Y-1169	1	Shift Fork	
17	3107-F-1020	1	Shift Collar	
18	KIT 4429	1	DCDL Switch Kit	
19	1227-P-1056	1	Sensor Adjusting Nut	

KIT 2424

ITEM	PART NUMBER	QTY.	DESCRIPTION	REMARKS
1	2234-T-1190	1	Differential Side Gear, Finished	I.A.D. nest with spider RD-23-160, RD-23-164, RD-26-160, RP-23-160, RP-23-164, RP-26-160 3200-J-1648, 3200-J-1908, 3200-K-1701, 3200-K-1857, 3200-K-1909, 3200-L-1858, 3200-M-1703, 3200-P-1628, 3200-Q-1837, 3200-V-1894, 3200-W-1713, 3200-W-1895, 3200-X-1818, 3200-Y-1819, 3200-Z-1820, 3200-J-2116, 3200-K-2117, 3200-L-2118
2	3892-T-4934	1	Integral Gear (Helical, Forward, Side Gear)	
3	3278-N-300	1	Differential Spider	
4	2233-K-245	4	Differential Pinion, Finished	
5	1229-Q-2929	4	Pinion Thrust Washer	
6	1229-S-4985	1	Thrust Washer	
7	2297-S-5349	1	Snap Ring	

SERVICE KITS

KIT 2426

ITEM	PART NUMBER	QTY.	DESCRIPTION	REMARKS
1	1229-U-1503	12	Washer	Gear to case bolt kit (16.5 mm bolts after 4-88) RD-23-160, RD-23-164, RD-26-160, RP-23-160, RP-23-164, RP-26-160, RR-23-160, RR-23-164, RR-26-160, RS-23-160, RS-23-161, RS-25-160, RS-26-160
2	40-X-1182	12	Lock Nut	
3	41-X-1276	12	Capscrew	

KIT 2429

ITEM	PART NUMBER	QTY.	DESCRIPTION	REMARKS
1	2203-K-9241	1	Shim - .076mm/.003 in.	RD-23-160, RD-23-164, RD-26-160, RP-23-160, RP-23-164, RP-26-160
2	2203-L-9242	1	Shim - .127mm/.005 in.	
3	2203-M-9243	4	Shim - .254mm/.010 in.	
4	2203-F-2788	1	Shim - .076mm/.003 in.	
5	2203-G-2789	1	Shim - .127mm/.005 in.	
6	2203-H-2790	4	Shim - .254mm/.010 in.	

KIT 2483

ITEM	PART NUMBER	QTY.	DESCRIPTION	REMARKS
1	3892-T-4934	1	Integral Gear (Helical, Forward, Side Gear)	RD-23-160, RD-23-164, RD-26-160, RP-23-160, RP-23-164, RP-26-160
2	3892-U-4909	1	Helical Gear	

KIT 2489

ITEM	PART NUMBER	QTY.	DESCRIPTION	REMARKS
1	2234-T-1190	1	Differential Side Gear, Finished	I.A.D. nest less spider
2	3892-T-4934	1	Integral Gear (Helical, Forward, Side Gear)	RD-23-160, RD-23-164, RD-26-160, RP-23-160, RP-23-164, RP-26-160
3	2233-K-245	4	Differential Pinion, Finished	
4	1229-Q-2929	4	Pinion Thrust Washer	3200-J-1648, 3200-J-1908, 3200-K-1701, 3200-K-1857, 3200-K-1909, 3200-L-1858, 3200-M-1703, 3200-P-1628, 3200-Q-1837, 3200-V-1894, 3200-W-1713, 3200-W-1895, 3200-X-1818, 3200-Y-1819, 3200-Z-1820, 3200-J-2116, 3200-K-2117, 3200-L-2118
5	1229-S-4985	1	Thrust Washer	

KIT 2575

ITEM	PART NUMBER	QTY.	DESCRIPTION	REMARKS
1	2234-C-1069N	2	Side Gear	Coach Quality main diff. kit with spider. RS-23-160, RS-23-161, RS-25-160
2	2233-M-1001	4	Differential Pinion	
3	3278-W-335	1	Spider	
4	1229-K-3001	4	Thrust Washer	
5	1229-L-3002	2	Thrust Washer	

KIT 2614

ITEM	PART NUMBER	QTY.	DESCRIPTION	REMARKS
1	2230-N-170	1	Piston	Main diff. lock piston kit.
2	5-X-1153	1	O-Ring	RD-23-160, RD-23-164, RD-26-160, RP-23-160, RP-23-164, RP-26-160, RS-23-160, RS-23-161, RS-25-160, RS-26-160
3	41-X-1333	1	Capscrew	
4	41-X-1359	4	Shift Unit Bolt	3200-C-1511, 3200-Z-1560, 3200-P-1628, 3200-V-1660, 3200-K-1701, 3200-R-1708, 3200-V-1712, 3200-W-1713, 3200-Y-1819, 3200-Z-1820, 3200-C-1823, 3200-E-1825
5	MWA-506	4	Washer	

SERVICE KITS

KIT 2615

ITEM	PART NUMBER	QTY.	DESCRIPTION	REMARKS
1	3296-Y-1169	1	Shift Fork	Main diff. lock actuator kit.
2	3107-B-1094	1	Clutch Collar	RP-23-160, RP-23-164, RP-26-160, RS-23-160, RS-23-161, RS-25-160, RS-26-160 3200-K-1701, 3200-R-1708, 3200-V-1712, 3200-W-1713, 3200-Y-1819, 3200-Z-1820, 3200-C-1823, 3200-E-1825
3	43-X-1007	2	Shift Fork Pin	
4	2244-L-1026	1	Shift Shaft	
5	43-X-1006	1	Shift Shaft Pin	
6	2258-L-714	1	Spring	
7	3196-F-32	1	Air Cylinder tube	
8	2230-N-170	1	Piston	
9	5-X-1153	1	O-Ring	
10	2208-H-944	1	Gasket	
11	3266-F-1020	1	Cover	
12	MWA-506	4	Washer	
13	41-X-1364	4	Capscrew	
14	2208-L-1000	1	Gasket	
15	MS-210016-1	1	Capscrew	
16	41-X-1333	1	Capscrew	
17	KIT 4429	1	DCDL Switch Kit	
18	1227-P-1056	1	Sensor Adjusting Nut	

KIT 2616

ITEM	PART NUMBER	QTY.	DESCRIPTION	REMARKS
1	41-X-1080	4	Capscrew	Carrier and cap update kit RP-23-160, RP-23-164, RP-26-160 3200-K-1701
2	41-X-1364	4	Capscrew	
3	MWA-506	4	Washer	
4	KIT 2825	1	Shift Kit	
5	KIT 2763	1	Carrier & Cap Assembly	

KIT 2618

ITEM	PART NUMBER	QTY.	DESCRIPTION	REMARKS
1	A2-3200-J-2116S	1	Carrier & Cap Assembly	Carrier and cap update kit RD-23-160, RD-23-164, RD-26-160 3200-M-1703
2	KIT 2825	1	Shift Kit	

KIT 2624

ITEM	PART NUMBER	QTY.	DESCRIPTION	REMARKS
1	A1-3297-S-1605	1	Input Shaft	Pump update kit RD-23-160, RD-23-164, RD-26-160 3200-P-1628
2	A-3303-P-1030	1	Oil Pump Assembly	

SERVICE KITS

KIT 2637

ITEM	PART NUMBER	QTY.	DESCRIPTION	REMARKS
1	40-X-1237	1	Input Nut	M39 x 1.5 nut thread. Front input, rear input.
2	1229-T-1736	1	Washer	RD160, RD164, RP160, RP164, RR160, RR164, RS160, RS161

KIT 2638

ITEM	PART NUMBER	QTY.	DESCRIPTION	REMARKS
1	40-X-1233	1	Lock Nut	M45 x 1.5 nut thread. Front input.
2	1229-W-4521	1	Washer	RD160, RD164, RP160, RP164, RR160, RR164, RS160, RS161

KIT 2640

ITEM	PART NUMBER	QTY.	DESCRIPTION	REMARKS
1	KIT 2763	1	Carrier & Cap Assembly	Carrier and cap update kit (with diff case assembly, fast ratios) for diff. lock RD-23-160, RD-23-164, RD-26-160 3200-P-1628
2	A2-3261-Q-1057	1	IAD Shift Cylinder Assembly	
3	3107-B-1094	1	Clutch Collar	
4	41-X-1364	4	Capscrew	
5	MWA-506	4	Washer	
6	2214-G-1125	1	Adjusting Ring	
7	2214-J-1128	1	Adjusting Ring	
8	592A	1	Bearing Cup	
9	594A	1	Differential Bearing Cone	
10	52618	1	Bearing Cup	
11	52400	1	Differential Bearing Cone	
12	A2-3235-C-2109	1	Unloaded Differential Case	

KIT 2640A

ITEM	PART NUMBER	QTY.	DESCRIPTION	REMARKS
1	KIT 2763	1	Carrier & Cap Assembly	Carrier and cap update kit (with diff case assembly, mid-range ratios) for diff. lock RD-23-160, RD-23-164, RD-26-160 3200-P-1628
2	A2-3261-Q-1057	1	IAD Shift Cylinder Assembly	
3	3107-B-1094	1	Clutch Collar	
4	41-X-1364	4	Capscrew	
5	MWA-506	4	Washer	
6	2214-G-1125	1	Adjusting Ring	
7	2214-J-1128	1	Adjusting Ring	
8	592A	1	Bearing Cup	
9	594A	1	Differential Bearing Cone	
10	52618	1	Bearing Cup	
11	52400	1	Differential Bearing Cone	
12	A2-3235-E-2111	1	Unloaded Differential Case	

KIT 2640B

ITEM	PART NUMBER	QTY.	DESCRIPTION	REMARKS
1	KIT 2763	1	Carrier & Cap Assembly	Carrier and cap update kit (with diff case assembly, standard ratios) for diff. lock RD-23-160, RD-23-164, RD-26-160 3200-P-1628
2	A2-3261-Q-1057	1	IAD Shift Cylinder Assembly	
3	3107-B-1094	1	Clutch Collar	
4	41-X-1364	4	Capscrew	
5	MWA-506	4	Washer	
6	2214-G-1125	1	Adjusting Ring	
7	2214-J-1128	1	Adjusting Ring	
8	592A	1	Bearing Cup	
9	594A	1	Differential Bearing Cone	
10	52618	1	Bearing Cup	
11	52400	1	Differential Bearing Cone	
12	A2-3235-G-2113	1	Unloaded Differential Case	

SERVICE KITS

KIT 2641

ITEM	PART NUMBER	QTY.	DESCRIPTION	REMARKS
1	KIT 2766	1	Carrier & Cap Assembly	Carrier and cap update kit (with diff case assembly, fast ratios) less diff. lock RP-23-160, RP-23-164, RP-26-160 3200-P-1628
2	A2-3261-Q-1057	1	IAD Shift Cylinder Assembly	
3	41-X-1080	4	Capscrew	
4	MWA-506	4	Washer	
5	2214-G-1125	1	Adjusting Ring	
6	2214-J-1128	1	Adjusting Ring	
7	594A	1	Differential Bearing Cone	
8	592A	1	Bearing Cup	
9	52400	1	Differential Bearing Cone	
10	52618	1	Bearing Cup	
11	A5-3235-C-2109	1	Unloaded Differential Case	

KIT 2641A

ITEM	PART NUMBER	QTY.	DESCRIPTION	REMARKS
1	KIT 2766	1	Carrier & Cap Assembly	Carrier and cap update kit (with diff case assembly, mid-range ratios) less diff. lock RP-23-160, RP-23-164, RP-26-160 3200-P-1628
2	A2-3261-Q-1057	1	IAD Shift Cylinder Assembly	
3	41-X-1080	4	Capscrew	
4	MWA-506	4	Washer	
5	2214-G-1125	1	Adjusting Ring	
6	2214-J-1128	1	Adjusting Ring	
7	594A	1	Differential Bearing Cone	
8	592A	1	Bearing Cup	
9	52400	1	Differential Bearing Cone	
10	52618	1	Bearing Cup	
11	A5-3235-E-2111	1	Unloaded Differential Case	

KIT 2641B

ITEM	PART NUMBER	QTY.	DESCRIPTION	REMARKS
1	KIT 2766	1	Carrier & Cap Assembly	Carrier and cap update kit (with diff case assembly, standard ratios) less diff. lock RP-23-160, RP-23-164, RP-26-160 3200-P-1628
2	A2-3261-Q-1057	1	IAD Shift Cylinder Assembly	
3	41-X-1080	4	Capscrew	
4	MWA-506	4	Washer	
5	2214-G-1125	1	Adjusting Ring	
6	2214-J-1128	1	Adjusting Ring	
7	594A	1	Differential Bearing Cone	
8	592A	1	Bearing Cup	
9	52400	1	Differential Bearing Cone	
10	52618	1	Bearing Cup	
11	A5-3235-G-2113	1	Unloaded Differential Case	

KIT 2642

ITEM	PART NUMBER	QTY.	DESCRIPTION	REMARKS
1	A2-3200-P-1706	1	Carrier & Cap Assembly	Carrier and cap update kit (with diff case assembly, fast ratios) less diff. lock RS-23-160, RS-23-161, RS-25-160, RS-26-160 3200-T-1658, 3200-Z-1560
2	2214-G-1125	2	Adjusting Ring	
3	592A	2	Bearing Cup	
4	594A	2	Differential Bearing Cone	
5	1228-B-1042	1	Spigot Bearing	
6	A-3235-C-2109	1	Unloaded Differential Case	

KIT 2642A

ITEM	PART NUMBER	QTY.	DESCRIPTION	REMARKS
1	A2-3200-P-1706	1	Carrier & Cap Assembly	Carrier and cap update kit (with diff case assembly, mid-range ratios) less diff. lock RS-23-160, RS-23-161, RS-25-160, RS-26-160 3200-T-1658, 3200-Z-1560
2	2214-G-1125	2	Adjusting Ring	
3	592A	2	Bearing Cup	
4	594A	2	Differential Bearing Cone	
5	1228-B-1042	1	Spigot Bearing	
6	A-3235-E-2111	1	Unloaded Differential Case	

SERVICE KITS

KIT 2642B

ITEM	PART NUMBER	QTY.	DESCRIPTION	REMARKS
1	A2-3200-P-1706	1	Carrier & Cap Assembly	Carrier and cap update kit (with diff case assembly, standard ratios) less diff. lock RS-23-160, RS-23-161, RS-25-160, RS-26-160 3200-T-1658, 3200-Z-1560
2	A-3235-G-2113	1	Unloaded Differential Case	
3	594A	2	Differential Bearing Cone	
4	592A	2	Bearing Cup	
5	2214-G-1125	2	Adjusting Ring	
6	1228-B-1042	1	Spigot Bearing	

KIT 2643

ITEM	PART NUMBER	QTY.	DESCRIPTION	REMARKS
1	KIT 2762	1	Carrier & Cap Assembly	Carrier and cap update kit (with diff case assembly, fast ratios) for diff. lock. RS-23-160, RS-23-161, RS-25-160, RS-26-160 3200-V-1660, 3200-Z-1560
2	3107-B-1094	1	Clutch Collar	
3	A2-3235-C-2109	1	Unloaded Differential Case	
4	2214-G-1125	1	Adjusting Ring	
5	2214-J-1128	1	Adjusting Ring	
6	1228-B-1042	1	Spigot Bearing	
7	41-X-1364	4	Capscrew	
8	594A	1	Differential Bearing Cone	
9	592A	1	Bearing Cup	
10	52400	1	Differential Bearing Cone	
11	52618	1	Bearing Cup	
12	MWA-506	4	Washer	

KIT 2643A

ITEM	PART NUMBER	QTY.	DESCRIPTION	REMARKS
1	KIT 2762	1	Carrier & Cap Assembly	Carrier and cap update kit (with diff case assembly, mid-range ratios) for diff. lock RS-23-160, RS-23-161, RS-25-160, RS-26-160 3200-V-1660, 3200-Z-1560
2	A2-3235-E-2111	1	Unloaded Differential Case	
3	3107-B-1094	1	Clutch Collar	
4	2214-J-1128	1	Adjusting Ring	
5	2214-G-1125	1	Adjusting Ring	
6	1228-B-1042	1	Spigot Bearing	
7	594A	1	Differential Bearing Cone	
8	592A	1	Bearing Cup	
9	52400	1	Differential Bearing Cone	
10	52618	1	Bearing Cup	
11	41-X-1364	4	Capscrew	
12	MWA-506	4	Washer	

KIT 2643B

ITEM	PART NUMBER	QTY.	DESCRIPTION	REMARKS
1	KIT 2762	1	Carrier & Cap Assembly	Carrier and cap update kit (with diff case assembly, standard ratios) for diff. lock RS-23-160, RS-23-161, RS-25-160, RS-26-160 3200-V-1660, 3200-Z-1560
2	A2-3235-G-2113	1	Unloaded Differential Case	
3	3107-B-1094	1	Clutch Collar	
4	2214-J-1128	1	Adjusting Ring	
5	2214-G-1125	1	Adjusting Ring	
6	1228-B-1042	1	Spigot Bearing	
7	594A	1	Differential Bearing Cone	
8	592A	1	Bearing Cup	
9	52400	1	Differential Bearing Cone	
10	52618	1	Bearing Cup	
11	41-X-1364	4	Capscrew	
12	MWA-506	4	Washer	

KIT 2644

ITEM	PART NUMBER	QTY.	DESCRIPTION	REMARKS
1	A2-3200-X-1818	1	Carrier & Cap Assembly	Carrier and cap update kit (with diff case assembly, fast ratios) less diff. lock. Conversion kit from bolt-on to screw-in I.A.D. shifter. RD-23-160, RD-23-164, RD-26-160 3200-J-1648
2	A-3235-C-2109	1	Unloaded Differential Case	
3	A2-3261-Q-1057	1	IAD Shift Cylinder Assembly	
4	594A	2	Differential Bearing Cone	
5	592A	2	Bearing Cup	
6	2214-G-1125	2	Adjusting Ring	

SERVICE KITS

KIT 2644A

ITEM	PART NUMBER	QTY.	DESCRIPTION	REMARKS
1	A2-3200-X-1818	1	Carrier & Cap Assembly	Carrier and cap update kit (with diff case assembly, mid-range ratios) less diff. lock. Conversion kit from bolt-on to screw-in I.A.D. shifter. RD-23-160, RD-23-164, RD-26-160 3200-J-1648
2	A-3235-E-2111	1	Unloaded Differential Case	
3	A2-3261-Q-1057	1	IAD Shift Cylinder Assembly	
4	594A	2	Differential Bearing Cone	
5	592A	2	Bearing Cup	
6	2214-G-1125	2	Adjusting Ring	

KIT 2644B

ITEM	PART NUMBER	QTY.	DESCRIPTION	REMARKS
1	A2-3200-X-1818	1	Carrier & Cap Assembly	Carrier and cap update kit (with diff case assembly, standard ratios) less diff. lock. Conversion kit from bolt-on to screw-in I.A.D. shifter. RD-23-160, RD-23-164, RD-26-160 3200-J-1648
2	A-3235-G-2113	1	Unloaded Differential Case	
3	A2-3261-Q-1057	1	IAD Shift Cylinder Assembly	
4	592A	2	Bearing Cup	
5	594A	2	Differential Bearing Cone	
6	2214-G-1125	2	Adjusting Ring	

KIT 2657

ITEM	PART NUMBER	QTY.	DESCRIPTION	REMARKS
1	KIT 2634	1	Carrier & Cap Update Kit	Carrier and cap update kit (with diff case assembly, fast ratios) less diff. lock RS-23-160, RS-23-161, RS-25-160, RS-26-160 3200-C-1511
2	A5-3235-C-2109	1	Unloaded Differential Case	
3	594A	1	Differential Bearing Cone	
4	592A	1	Bearing Cup	
5	52618	1	Bearing Cup	
6	52400	1	Differential Bearing Cone	
7	2214-J-1128	1	Adjusting Ring	
8	2214-G-1125	1	Adjusting Ring	
9	1228-B-1042	1	Spigot Bearing	

KIT 2657A

ITEM	PART NUMBER	QTY.	DESCRIPTION	REMARKS
1	KIT 2634	1	Carrier & Cap Update Kit	Carrier and cap update kit (with diff case assembly, mid-range ratios) less diff. lock RS-23-160, RS-23-161, RS-25-160, RS-26-160 3200-C-1511
2	A5-3235-E-2111	1	Unloaded Differential Case	
3	2214-G-1125	1	Adjusting Ring	
4	2214-J-1128	1	Adjusting Ring	
5	594A	1	Differential Bearing Cone	
6	592A	1	Bearing Cup	
7	52400	1	Differential Bearing Cone	
8	52618	1	Bearing Cup	
9	1228-B-1042	1	Spigot Bearing	

KIT 2657B

ITEM	PART NUMBER	QTY.	DESCRIPTION	REMARKS
1	KIT 2634	1	Carrier & Cap Update Kit	Carrier and cap update kit (with diff case assembly, standard ratios) less diff. lock RS-23-160, RS-23-161, RS-25-160, RS-26-160 3200-C-1511
2	A5-3235-G-2113	1	Unloaded Differential Case	
3	2214-G-1125	1	Adjusting Ring	
4	2214-J-1128	1	Adjusting Ring	
5	594A	1	Differential Bearing Cone	
6	592A	1	Bearing Cup	
7	52400	1	Differential Bearing Cone	
8	52618	1	Bearing Cup	
9	1228-B-1042	1	Spigot Bearing	

SERVICE KITS

KIT 2658

ITEM	PART NUMBER	QTY.	DESCRIPTION	REMARKS
1	KIT 2634	1	Carrier & Cap Update Kit	Carrier and cap update kit (with diff case assembly, fast ratios) for diff. lock RS-23-160, RS-23-161, RS-25-160, RS-26-160 3200-C-1511
2	A2-3235-C-2109	1	Unloaded Differential Case	
3	3107-B-1094	1	Clutch Collar	
4	2214-J-1128	1	Adjusting Ring	
5	2214-G-1125	1	Adjusting Ring	
6	1228-B-1042	1	Spigot Bearing	
7	594A	1	Differential Bearing Cone	
8	592A	1	Bearing Cup	
9	52400	1	Differential Bearing Cone	
10	52618	1	Bearing Cup	

KIT 2658A

ITEM	PART NUMBER	QTY.	DESCRIPTION	REMARKS
1	KIT 2634	1	Carrier & Cap Update Kit	Carrier and cap update kit (with diff case assembly, mid-range ratios) for diff. lock RS-23-160, RS-23-161, RS-25-160, RS-26-160 3200-C-1511
2	A2-3235-E-2111	1	Unloaded Differential Case	
3	3107-B-1094	1	Clutch Collar	
4	2214-J-1128	1	Adjusting Ring	
5	2214-G-1125	1	Adjusting Ring	
6	1228-B-1042	1	Spigot Bearing	
7	594A	1	Differential Bearing Cone	
8	592A	1	Bearing Cup	
9	52400	1	Differential Bearing Cone	
10	52618	1	Bearing Cup	

KIT 2658B

ITEM	PART NUMBER	QTY.	DESCRIPTION	REMARKS
1	KIT 2634	1	Carrier & Cap Update Kit	Carrier and cap update kit (with diff case assembly, standard ratios) for diff. lock RS-23-160, RS-23-161, RS-25-160, RS-26-160 3200-C-1511
2	A2-3235-G-2113	1	Unloaded Differential Case	
3	3107-B-1094	1	Clutch Collar	
4	2214-J-1128	1	Adjusting Ring	
5	2214-G-1125	1	Adjusting Ring	
6	1228-B-1042	1	Spigot Bearing	
7	594A	1	Differential Bearing Cone	
8	592A	1	Bearing Cup	
9	52400	1	Differential Bearing Cone	
10	52618	1	Bearing Cup	

KIT 2659

ITEM	PART NUMBER	QTY.	DESCRIPTION	REMARKS
1	KIT 2762	1	Carrier & Cap Assembly	Carrier and cap update kit (with diff. lock) RS-23-160, RS-23-161, RS-25-160, RS-26-160 3200-C-1823, 3200-D-1928, 3200-R-1708, 3200-T-1892
2	41-X-1364	4	Capscrew	
3	MWA-506	4	Washer	

KIT 2691

ITEM	PART NUMBER	QTY.	DESCRIPTION	REMARKS
1	A-3261-A-1067	1	DCDL Shift Cylinder	Main diff. lock, screw-in shift, Services all new style screw in type main differential lock carriers RD-23-160, RD-23-164, RD-26-160, RP-23-160, RP-23-164, RP-26-160 3200-T-1892, 3200-V-1894
2	2244-Z-1222	1	Push Rod	
3	5-X-521	1	O-Ring	
4	41-X-1368	1	Caging Bolt	

SERVICE KITS

KIT 2698

ITEM	PART NUMBER	QTY.	DESCRIPTION	REMARKS
1	3296-B-1172	1	Shift Fork	Main diff. lock kit.
2	3107-B-1094	1	Clutch Collar	RD-23-160, RD-23-164, RD-26-160, RP-23-160, RP-23-164,
3	2244-Z-1222	1	Push Rod	RP-26-160, RR-23-160, RR-23-164, RR-26-160, RS-23-160,
4	2258-N-1262	1	Spring	RS-23-161, RS-25-160, RS-26-160
5	A-3261-A-1067	1	DCDL Shift Cylinder	3200-T-1892, 3200-V-1894, 3200-W-1895, 3200-Y-1897,
6	2230-T-1190	1	Piston	3200-J-1908, 3200-K-1909, 3200-D-1928, 3200-E-1929,
7	41-X-1368	1	Caging Bolt	3200-K-2117, 3200-L-2118
8	5-X-521	1	O-Ring	
9	KIT 4429	1	DCDL Switch Kit	

KIT 2750

ITEM	PART NUMBER	QTY.	DESCRIPTION	REMARKS
1	2244-Z-1222	1	Push Rod	Screw-in shifter.
2	2258-N-1262	1	Spring	RD-23-160, RD-23-164, RD-26-160, RP-23-160, RP-23-164,
3	A-3261-A-1067	1	DCDL Shift Cylinder	RP-26-160
4	41-X-1368	1	Caging Bolt	3200-T-1892, 3200-V-1894, 3200-K-2117
5	5-X-521	1	O-Ring	

KIT 2762

ITEM	PART NUMBER	QTY.	DESCRIPTION	REMARKS
1	A2-3200-T-1892	1	Carrier & Cap Assembly	Carrier and cap update kit (with diff. lock)
2	KIT 2691	1	Shift Cylinder Kit	RR-23-160, RR-23-164, RR-26-160, RS-23-160, RS-23-161,
3	3296-B-1172	1	Shift Fork	RS-25-160, RS-26-160
4	2258-N-1262	1	Spring	3200-C-1823, 3200-D-1928, 3200-R-1708, 3200-T-1892,
5	2206-L-1156	1	Elbow Fitting	3200-V-1894, 3200-K-2117

KIT 2763

ITEM	PART NUMBER	QTY.	DESCRIPTION	REMARKS
1	A2-3200-K-2117S	1	Carrier & Cap Assembly	Carrier and cap update kit (with diff. lock, with pump)
2	KIT 2691	1	Shift Cylinder Kit	RP-23-160, RP-23-164, RP-26-160
3	3296-B-1172	1	Shift Fork	3200-V-1894, 3200-Z-1820, 3200-K-2117
4	2258-N-1262	1	Spring	
5	2206-L-1156	1	Elbow Fitting	

KIT 2764

ITEM	PART NUMBER	QTY.	DESCRIPTION	REMARKS
1	A2-3200-L-2118S	1	Carrier & Cap Assembly	Carrier and cap update kit (with diff. lock, less pump)
2	KIT 2691	1	Shift Cylinder Kit	RD-23-160, RD-23-164, RD-26-160
3	3296-B-1172	1	Shift Fork	3200-W-1895, 3200-Y-1819, 3200-L-2118
4	2258-N-1262	1	Spring	
5	2206-L-1156	1	Elbow Fitting	

KIT 2766

ITEM	PART NUMBER	QTY.	DESCRIPTION	REMARKS
1	A2-3200-K-2117S	1	Carrier & Cap Assembly	Carrier and cap update kit (less diff. lock, with pump). RP-23-160,
2	1250-U-1217	1	Plug	RP-23-164, RP-26-160. 3200-V-1894, 3200-Z-1820, 3200-K-2117

KIT 2796

ITEM	PART NUMBER	QTY.	DESCRIPTION	REMARKS
1	A1-3235-A-2393	1	Differential Case Assembly	I.A.D. assembly. RD-23-160, RD-23-164, RD-26-160, RP-23-160,
2	KIT 2424	1	IAD Kit with Spider	RP-23-164, RP-26-160

KIT 2824

ITEM	PART NUMBER	QTY.	DESCRIPTION	REMARKS
1	A-3261-A-1067	1	DCDL Shift Cylinder	Main differential kit
2	2244-Z-1222	1	Push Rod	160 Series

KIT 2825

ITEM	PART NUMBER	QTY.	DESCRIPTION	REMARKS
1	A4-3261-Q-1057	1	IAD Shift Cylinder	I.A.D. kit
2	2244-Y-1221	1	Push Rod	160 Series

SERVICE KITS

KIT 2826

ITEM	PART NUMBER	QTY.	DESCRIPTION	REMARKS
1	40-X-1233	1	Locknut	Input shaft nut and washer kit
2	1229-N-1730	1	Washer	

KIT 2830

ITEM	PART NUMBER	QTY.	DESCRIPTION	REMARKS
1	2214-N-1262	1	Adjusting Ring	Adjusting ring kit
2	1229-F-4452	2	Snap Ring	

KIT 2902

ITEM	PART NUMBER	QTY.	DESCRIPTION	REMARKS
1	A-2297-C-8765	1	Breather	Breather kit
2	A-3196-J-1336	1	Breather Tube	

KIT 4284

ITEM	PART NUMBER	QTY.	DESCRIPTION	REMARKS
1	41-X-1637	2	Capscrew	Lock pin kit 160 Series
2	1199-R-2176	2	Cotter Pin	
3	1246-P-1134	1	Spirol Pin	

KIT 4288

ITEM	PART NUMBER	QTY.	DESCRIPTION	REMARKS
1	10-X-1595	4	Bolt	For Tapered Dowel 164EH Forward Carriers RD-23-164, RP-23-164 3200-J-2116, 3200-K-2117, 3200-L-2118
2	10-X-1599	2	Bolt	
3	1246-V-1166	6	Dowel	

KIT 4291

ITEM	PART NUMBER	QTY.	DESCRIPTION	REMARKS
1	10-X-1595	3	Bolt	Tapered Dowel for RR-23-164 3200-E-2137, 3200-F-2138
2	10-X-1767	1	Bolt	
3	1246-V-1166	4	Dowel	

KIT 4415

ITEM	PART NUMBER	QTY.	DESCRIPTION	REMARKS
1	A1-1205-A-2731	1	Oil Seal Assembly	RS-23-160, RS-23-161, RS-25-160, RS-26-160 3200-C-1511, 3200-T-1658, 3200-V-1660, 3200-Z-1560
2	HM813843	1	Bearing Cone	
3	9220	1	Bearing Cup	
4	HM813810	1	Bearing Cup	
5	A1-1228-B-600	2	Bearing Assembly	
6	1228-V-594	1	Bearing	
7	A1-1228-P-1004	1	Bearing Assembly	

KIT 4420

ITEM	PART NUMBER	QTY.	DESCRIPTION	REMARKS
1	65500	1	Bearing Cup	RD-23-160, RD-23-164, RD-26-160, RP-23-160, RP-23-164, RP-26-160 3200-J-1648, 3200-P-1628
2	65237	1	Bearing Cone	
3	H715311	1	Bearing Cup	
4	H715343	1	Bearing Cone	
5	HM813810	1	Bearing Cup	
6	HM813843	1	Bearing Cone	
7	JLM714110	1	Bearing Cup	
8	JLM714149	1	Bearing Cone	
9	A1-1228-B-600	2	Bearing Assembly	
10	A-1205-X-2728	1	Oil Seal Assembly	
11	5-X-1034	1	O-Ring	
12	5-X-1343	1	O-Ring	

SERVICE KITS

KIT 4422

ITEM	PART NUMBER	QTY.	DESCRIPTION	REMARKS
1	592A	2	Bearing Cup	RD-23-160, RD-23-164, RD-26-160 3200-K-1857, 3200-M-1703, 3200-Q-1837, 3200-X-1818, 3200-J-2116
2	594A	2	Differential Bearing Cone	
3	65237	1	Bearing Cone	
4	65500	1	Bearing Cup	
5	H715311	1	Bearing Cup	
6	H715343	1	Bearing Cone	
7	HM813810	1	Bearing Cup	
8	HM813843	1	Bearing Cone	
9	JLM714110	1	Bearing Cup	
10	JLM714149	1	Bearing Cone	
11	5-X-1343	1	O-Ring	
12	A-1205-X-2728	1	Oil Seal Assembly	

KIT 4423

ITEM	PART NUMBER	QTY.	DESCRIPTION	REMARKS
1	52400	1	Differential Bearing Cone	For all diff. lock capable except original design. RD-23-160, RD-23-164, RD-26-160, RP-23-160, RP-23-164, RP-26-160 3200-K-1701, 3200-L-1858, 3200-V-1894, 3200-W-1713, 3200-W1895, 3200-Y-1819, 3200-Z-1820, 3200-K-2117, 3200-L-2118
2	52618	1	Bearing Cup	
3	592A	1	Bearing Cup	
4	594A	1	Differential Bearing Cone	
5	65237	1	Bearing Cone	
6	65500	1	Bearing Cup	
7	A-1205-X-2728	1	Oil Seal Assembly	
8	H715343	1	Bearing Cone	
9	H715311	1	Bearing Cup	
10	HM-813810	1	Bearing Cup	
11	HM813843	1	Bearing Cone	
12	JLM714110	1	Bearing Cup	
13	JLM714149	1	Bearing Cone	
14	5-X-1034	1	O-Ring	
15	5-X-1343	1	O-Ring	

KIT 4426

ITEM	PART NUMBER	QTY.	DESCRIPTION	REMARKS
1	1228-B-1042	1	Spigot Bearing	Less Diff. Lock RS-23-160, RS-23-161, RS-25-160, RS-26-160 3200-A-1821, 3200-H-1854, 3200-J-1856, 3200-P-1706
2	1228-V-594	1	Bearing	
3	A1-1205-A-2731	1	Oil Seal Assembly	
4	592A	2	Bearing Cup	
5	594A	2	Differential Bearing Cone	
6	9220	1	Bearing Cup	
7	HM813810	1	Bearing Cup	
8	HM813843	1	Bearing Cone	

KIT 4428

ITEM	PART NUMBER	QTY.	DESCRIPTION	REMARKS
1	1228-B-1042	1	Spigot Bearing	With Diff. Lock RS-23-160, RS-23-161, RS-25-160, RS-26-160 3200-C-1823, 3200-D-1928, 3200-E-1825, 3200-E-1929, 3200-R-1708, 3200-T-1892, 3200-V-1712, 3200-Y-1897
2	1228-V-594	1	Bearing	
3	A1-1205-A-2731	1	Oil Seal Assembly	
4	52400	1	Differential Bearing Cone	
5	52618	1	Bearing Cup	
6	592A	1	Bearing Cup	
7	594A	1	Differential Bearing Cone	
8	9220	1	Bearing Cup	
9	HM813810	1	Bearing Cup	
10	HM813843	1	Bearing Cone	

KIT 4429

ITEM	PART NUMBER	QTY.	DESCRIPTION	REMARKS
1	3237-R-1292	1	DCDL Switch	DCDL Switch Kit
2	3237-X-1298	1	DCDL Harness	

SERVICE KITS

KIT 4745

ITEM	PART NUMBER	QTY.	DESCRIPTION	REMARKS
1	41-X-1555	12	Capscrew	Coach Quality gear to case bolt kit (16.5 mm bolts after 4-88) RD-23-160, RD-23-164, RD-26-160, RP-23-160, RP-23-164, RP-26-160, RR-23-160, RR-23-164, RR-26-160, RS-23-160, RS-23-161, RS-25-160, RS-26-160
2	40-X-1182	12	Lock Nut	
3	1229-U-1503	12	Washer	

KIT 2468 391

ITEM	PART NUMBER	QTY.	DESCRIPTION	REMARKS
1	A2-3235-F-1982	1	Unloaded Differential Case	Diff. case and gearset update with diff. lock, prior to 9/1/88. RS-23-160, RS-23-161, RS-25-160, RS-26-160 3200-Z-1560
2	A-39884-6	1	Gearset	
3	KIT 2426	1	Bolt Kit	

KIT 2468 410

ITEM	PART NUMBER	QTY.	DESCRIPTION	REMARKS
1	A2-3235-F-1982	1	Unloaded Differential Case	Diff. case and gearset update with diff. lock, prior to 9/1/88. RS-23-160, RS-23-161, RS-25-160, RS-26-160 3200-Z-1560
2	A-39886-6	1	Gearset	
3	KIT 2426	1	Bolt Kit	

KIT 2468 430

ITEM	PART NUMBER	QTY.	DESCRIPTION	REMARKS
1	A2-3235-F-1982	1	Unloaded Differential Case	Diff. case and gearset update with diff. lock, prior to 9/1/88. RS-23-160, RS-23-161, RS-25-160, RS-26-160 3200-Z-1560
2	A-39888-6	1	Gearset	
3	KIT 2426	1	Bolt Kit	

KIT 2468 456

ITEM	PART NUMBER	QTY.	DESCRIPTION	REMARKS
1	A2-3235-F-1982	1	Unloaded Differential Case	Diff. case and gearset update with diff. lock, prior to 9/1/88. RS-23-160, RS-23-161, RS-25-160, RS-26-160 3200-Z-1560
2	A-39890-6	1	Gearset	
3	KIT 2426	1	Bolt Kit	

KIT 2655 391

ITEM	PART NUMBER	QTY.	DESCRIPTION	REMARKS
1	A-39884-6	1	Gearset	Diff. case and gearset upgrade kit. RS-23-160, RS-23-161, RS-25-160, RS-26-160 3200-C-1511
2	A12-3235-F-1982	1	Unloaded Differential Case	
3	KIT 2426	1	Bolt Kit	

KIT 2655 410

ITEM	PART NUMBER	QTY.	DESCRIPTION	REMARKS
1	A-39886-6	1	Gearset	Diff. case and gearset upgrade kit. RS-23-160, RS-23-161, RS-25-160, RS-26-160 3200-C-1511
2	A12-3235-F-1982	1	Unloaded Differential Case	
3	KIT 2426	1	Bolt Kit	

KIT 2655 430

ITEM	PART NUMBER	QTY.	DESCRIPTION	REMARKS
1	A-39888-6	1	Gearset	Diff. case and gearset upgrade kit. RS-23-160, RS-23-161, RS-25-160, RS-26-160 3200-C-1511
2	A12-3235-F-1982	1	Unloaded Differential Case	
3	KIT 2426	1	Bolt Kit	

KIT 2655 456

ITEM	PART NUMBER	QTY.	DESCRIPTION	REMARKS
1	A-39890-6	1	Gearset	Diff. case and gearset upgrade kit. RS-23-160, RS-23-161, RS-25-160, RS-26-160 3200-C-1511
2	A12-3235-F-1982	1	Unloaded Differential Case	
3	KIT 2426	1	Bolt Kit	

NUMERICAL PARTS LISTING

Part Number	Page
4-X-1921	15
4-X-1922	15
5-X-521	6,13
5-X-1034	7
5-X-1153	6,13
5-X-1198	6,13
5-X-1343	3
10-X-1334	3
10-X-1594	4,15
10-X-1595	15
10-X-1599	4,15
10-X-1600	15
15-X-387	14
15-X-1167	4,10
19-X-1087	6,10
40-X-1145	4
40-X-1182	6,10
40-X-1233	3,9
40-X-1237	14
41-X-1018	6,10
41-X-1022	6,13
41-X-1208	3
41-X-1275	5,12
41-X-1276	6,10
41-X-1333	6,13
41-X-1364	6,13
41-X-1368	6,13
42-X-1024	6,10
42-X-1027	6,13
42-X-1408	7,13
43-X-1006	6,13
43-X-1007	7,13
46-X-1029	10
A-1199-W-4053	15
1199-E-1669	15
A-1205-T-696	15
A-1205-Q-2487	15
A1-1205-X-2728	3
A1-1205-Y-2729	13
A1-1205-A-2731	9
1220-K-89	13
1227-R-330	15
1227-D-472	4,10
1227-W-517	15
1227-P-1056	6,13
1228-V-594	9
A1-1228-B-600	5,10
A1-1228-P-1004	9
1228-B-1042	9
1228-Y-1221	9
1229-U-1009	15

Part Number	Page
1229-U-1503	5,6,10,12
1229-W-1557	4,15
1229-K-1597	3,4,14
1229-E-1669	3,7
1229-N-1730	3,9
1229-T-1736	14
1229-P-2590	14
1229-Q-2591	14
1229-R-2592	14
1229-S-2593	14
1229-T-2594	14
1229-U-2595	14
1229-V-2596	14
1229-W-2597	14
1229-X-2598	14
1229-Y-2599	14
1229-Q-2929	3
1229-K-3001	6,12
1229-L-3002	6,12
1229-F-4062	7
1229-G-4063	4
1229-W-4131	14
1229-F-4452	7,13
1229-U-4519	7,13
1229-D-4528	7,13
1229-F-4634S	15
1229-S-4985	3
1244-W-1765	4
1246-M-1131	7
1250-E-473	15
1250-N-1080	7
1250-T-1216	7,13
1250-U-1217	6,13
2203-F-2788	4
2203-G-2789	4
2203-H-2790	4
2203-K-9241	3
2203-L-9242	3
2203-M-9243	3
2203-V-9824	4
2203-W-9825	4
2203-X-9826	4
2203-Y-9827	4
2203-Z-9828	4
2203-A-9829	4
2203-B-9830	4
2203-C-9831	4
2203-D-9832	4
2203-E-9833	4
2203-F-9834	4
2203-G-9835	4

Part Number	Page
2203-H-9836	4
2203-J-9838	4
2203-K-9839	4
2203-L-9840	4
2208-H-944	6,13
2208-L-1000	6,13
2214-G-1125	5,10
2214-J-1128	5,10
2214-Z-1144	4,10
2214-U-1269	4,10
2230-N-170	6,13
2233-K-245	3
2233-M-1001	6,12
2234-C-1069	6,12
2234-D-1070	12
2234-T-1190	3
2244-Y-51	6,13
2244-L-1026	6,13
2258-U-411	3
2258-L-714	6,13
2258-Z-1118	7
2258-G-1255	7,13
2258-N-1262	6,13
2297-T-4180	10
2297-U-5273	7
2297-Z-5278	7
A-2297-D-5334	7
2297-S-5349	3
2297-C-7049	12
2803-D-2500	9
2803-E-2501	9
2803-F-2502	9
2803-G-2503	9
2803-H-2504	9
2803-J-2506	9
2803-K-2507	9
2803-L-2508	9
2803-M-2509	9
2803-N-2510	9
2803-Y-2755	9
2803-Z-2756	9
2803-A-2757	9
2803-B-2758	9
3107-F-1020	6,13
3107-P-1030	13
3107-B-1094	6,13
3107-C-1095	13
3107-P-1212	3
3196-F-32	6,13
A2-3200-P-1706	10
A2-3200-A-1821	10

NUMERICAL PARTS LISTING

Part Number	Page
A2-3200-Q-1837	3
A2-3200-H-1854	10
A2-3200-J-1856	10
A2-3200-K-1857	3
A2-3200-L-1858	3
A2-3200-T-1892	10
A2-3200-Y-1897	10
A2-3200-J-1908	3
A2-3200-K-1909	3,4
A2-3200-D-1928	10
A2-3200-E-1929	10
A2-3200-J-2116S	3
A2-3200-L-2118S	3
A2-3200-K-2117S	3,4
A2-3200-E-2137	10
A2-3200-F-2138	10
3202-X-8110	18
3202-Y-8683	18
3202-P-8804	18
3202-Q-8805	18
3202-R-8806	18
3202-A-8815	18
3202-B-8816	18
3202-C-8817	18
3202-G-9003	18
3202-H-9004	18
3202-Y-9125	18
3202-Z-9126	18
3202-A-9127	18
3202-B-9128	18
3202-C-9129	18
3202-D-9130	18
3202-J-9344	18
3202-K-9345	18
3202-L-9346	18
3202-G-9393	18
3202-Q-9403	18
3202-Y-9489	18
3202-Z-9490	18
3202-A-9491	18
3202-K-9553	18
3202-E-9573	18
3202-F-9574	18
3202-G-9575	18
3202-A-9647	18
3202-J-9916	18
3202-L-9918	18
3206-T-1190	18
3206-X-1532	18
3206-Z-1534	18
3216-G-4375	7,13

Part Number	Page
3221-P-1004	3
A-3226-R-1006	9
A-3226-T-1112	14
A2-3226-T-1112S	14
A-3226-H-1126	3
A-3226-S-1137	3
A-3230-C-1043	6,12
A-3235-S-1813	12
A2-3235-S-1813	11,12
A10-3235-S-1813	5,12
A11-3235-S-1813	5,11
A12-3235-S-1813	5,12
A13-3235-S-1813	5,11
A14-3235-S-1813	6,11
A2-3235-F-1982	12
A3-3235-F-1982	11
A10-3235-F-1982	5,12
A11-3235-F-1982	5,11
A12-3235-F-1982	5,12
A13-3235-F-1982	5,11
A14-3235-F-1982	6,11
A-3235-H-1984	12
A2-3235-H-1984	12
A3-3235-H-1984	11
A10-3235-H-1984	5,12
A11-3235-H-1984	5,11
A12-3235-H-1984	5,12
A13-3235-H-1984	5,11
A14-3235-H-1984	6,11
A-3235-C-2109	5,12
A1-3235-C-2109	5,11
A2-3235-C-2109	5,12
A3-3235-C-2109	5,11
A5-3235-C-2109	5,12
A6-3235-C-2109	5,11
A7-3235-C-2109	6,11
A8-3235-C-2109	6,11
A-3235-E-2111	5,12
A1-3235-E-2111	5,11
A2-3235-E-2111	5,12
A3-3235-E-2111	5,11
A5-3235-E-2111	5,12
A6-3235-E-2111	5,11
A7-3235-E-2111	6,11
A8-3235-E-2111	6,11
A-3235-G-2113	5,12
A1-3235-G-2113	5,11
A2-3235-G-2113	5,12
A3-3235-G-2113	5,11
A5-3235-G-2113	5,12
A6-3235-G-2113	5,11

Part Number	Page
A7-3235-G-2113	6,11
A8-3235-G-2113	6,11
A1-3235-R-2176	6,12
A2-3235-R-2176	5,11
A4-3235-R-2176	5,11
A5-3235-R-2176	6,12
A1-3235-S-2177	6,12
A2-3235-S-2177	5,11
A4-3235-S-2177	5,11
A5-3235-S-2177	6,12
A1-3235-T-2178	6,12
A2-3235-T-2178	5,11
A3-3235-T-2178	6,12
A4-3235-T-2178	11
A-3235-R-2202	12
A1-3235-R-2202	11
A2-3235-R-2202	12
A3-3235-R-2202	11
A1-3235-A-2393	3
A3-3235-A-2393	3
A5-3235-A-2393	3
A-3261-L-350	3
3264-N-1522	7
3266-F-1020	6,13
3266-C-1095	4
3278-N-300	3
3278-W-335	6,12
3280-V-8394	7
SA1-3280-X-9150	7,13
SA2-3280-X-9150	7,13
3296-B-184	7,13
3296-Y-1169	7,13
3296-B-1172	7,13
3296-B-1328	3
3297-V-1010	14
A1-3297-S-1605	3
A-3297-T-1606	3
A-3303-P-1030	7
3892-U-4909	4
3892-T-4934	3
572	15
580	15
592A	5,10,15
594A	5,10,15
9220	9
52400	5,10
52618	5,10
65237	4
65500	4
16N-4-6241	19
16N-4-6271	19

NUMERICAL PARTS LISTING

Part Number	Page
16N-4-7341-1X	21
16NYS38-8A	19
16NYS38-12A	19
16TYS32-76	21
176NYS38-14A	19
176TYS38-27A	21
17N-4-7181X	19
17N-4-7181-1X	21
17N-4-7621-1	21
17N-4-7771X	19
17NYS32-99	19
17NYS32-100	19
17NYS38-61A	19
17TYS32-99	21
18N-4-3731X	19
18N-4-3731-1X	21
5WCS38-18A	22
5WCS38-23A2	22
72NYS32-244	20
72NYS38-24A	20
72NYS38-26A	20
82NYS38-31A	20
92NYS32-26	20
92NYS38-73A	20
A-39654-1	4
A-39656-1	4
A-39658-1	4
A-39660-1	4
A-39662-1	4
A-39664-1	4
A-39666-1	4
A-39672-1	4
A-39674-1	4
A-39876-1	4
A-39878-1	4
A-39880-1	4
A-39882-1	4
A-39884-5	9
A-39886-5	9
A-39888-5	9
A-39890-5	9
A-39892-1	4
A-39896-1	4
A-39898-5	9
A-39900-5	9
A-39902-5	9
A-39904-5	9
A-39906-5	9
A-40024-5	9
A-40104-5	9
A-40106-5	9

Part Number	Page
A-40110-5	9
A-40116-5	9
A-40122-5	9
A-41064-1	4
A-41066-1	9
A-41572-1	9
A-41574-1	9
A-41828-1	9
A-41988-1	9
A-41990-1	9
A-41992-1	9
A-41994-1	9
A-41996-1	9
A-41998-1	9
A-42000-1	9
A-42002-1	9
A-42004-1	9
A-42006-1	9
A-42196-1	9
A-42466-1	9
A-42468-1	9
A-42470-1	9
A-42630-1	9
B-42776-1	9
B-43454-1	9
H715311	4
H715343	4
HM813810	3,9
HM813843	3,9
JLM104910	14
JLM714110	3
JLM714149	3
KIT 576	29
KIT 1592	29
KIT 1593	29
KIT 2317	29
KIT 2318	11,29
KIT 2341	29
KIT 2397	30
KIT 2406	30
KIT 2414	30
KIT 2424	30
KIT 2426	31
KIT 2429	31
KIT 2468 391	41
KIT 2468 410	41
KIT 2468 430	41
KIT 2468 456	41
KIT 2483	31
KIT 2489	31
KIT 2575	31

Part Number	Page
KIT 2614	31
KIT 2615	32
KIT 2616	4,32
KIT 2618	3,32
KIT 2624	3,7,32
KIT 2637	33
KIT 2638	33
KIT 2640	4,33
KIT 2640A	4,33
KIT 2640B	4,33
KIT 2641	34
KIT 2641A	34
KIT 2641B	34
KIT 2642	10,34
KIT 2642A	10,34
KIT 2642B	10,35
KIT 2643	10,35
KIT 2643A	10,35
KIT 2643B	10,35
KIT 2644	3,35
KIT 2644A	3,36
KIT 2644B	3,36
KIT 2655 391	41
KIT 2655 410	41
KIT 2655 430	41
KIT 2655 456	41
KIT 2657	10,36
KIT 2657A	10,36
KIT 2657B	10,36
KIT 2658	10,37
KIT 2658A	10,37
KIT 2658B	10,37
KIT 2659	10,37
KIT 2691	37
KIT 2698	38
KIT 2750	38
KIT 2762	10,38
KIT 2763	4,38
KIT 2764	3,38
KIT 2766	38
KIT 2796	38
KIT 2824	6,13,38
KIT 2825	3,38
KIT 2826	3,39
KIT 2830	5,10
KIT 2902	39
KIT 4284	6,10,39
KIT 4288	39
KIT 4291	39
KIT 4415	39
KIT 4420	39

NUMERICAL PARTS LISTING

Part Number	Page
KIT 4422	40
KIT 4423	40
KIT 4426	40
KIT 4428	40
KIT 4429	6,13,40
KIT 4745	41
KIT RP23160	28
KIT RP23160A	28
KIT RP23160B	28
KIT RR23160	28
KIT RR23160A	28
KIT RR23160B	28
LM-104949	14
MN-312-1	3
MS-208016-1	3
MS-208020-1	13
MS-208045-1	7
MS-210016-1	6,13
MS-210045A-1	3
MS-212040-2	3
MS-212045-1	9
MWA-506	6,13
MWA-508	13
MWA-512	3,9
N-110-1	15
NL-110-1	4
P-28-S	15
P-212	15

Part Number	Page
-------------	------

Part Number	Page
-------------	------

NOTES

NOTES

MERITOR AFTERMARKET PARTS WARRANTY

We warrant all new parts for one year from date of shipment to the buyer against defective material or workmanship (but not against damage caused by accident, abuse or improper installation, maintenance or repair) when such parts are used on vehicles the specifications of which have been approved by our Engineering Department.

As the exclusive remedy under this warranty, we will, at our option, repair or replace such parts free of charge, or take back the nonconforming parts and refund the monies paid by buyer for such parts, if found on examination by us to be nonconforming and if any necessary return charges are prepaid.

If it is necessary to return any parts under this warranty, buyer agrees not to make any deduction on account thereof from remittances on current accounts while claims are in the process of disposition. Any expense incurred without our consent for repairs or replacement will not be allowed.

THIS WARRANTY IS EXPRESSLY IN LIEU OF ALL OTHER WARRANTIES OR CONDITIONS, EXPRESS, IMPLIED OR STATUTORY, INCLUDING ANY IMPLIED WARRANTY OF MERCHANTABILITY OR FITNESS FOR PARTICULAR PURPOSE. IN NO EVENT SHALL SELLER BE LIABLE FOR INCIDENTAL OR CONSEQUENTIAL DAMAGES OF ANY NATURE.

Only genuine Meritor replacement parts are covered by this aftermarket parts warranty.

Distributed by:



ArvinMeritor[™]

Meritor Heavy Vehicle Systems, LLC
7975 Dixie Highway
Florence, Kentucky 41042 USA
888-725-9355

arvinmeritor.com
XpresswayPlus.arvinmeritor.com

Information contained in this publication was in effect at the time the publication was approved for printing and is subject to change without notice or liability. ArvinMeritor reserves the right to revise the information presented or discontinue the production of parts at any time.

Litho in USA
Revised 09-10
PB-9250 (13028/05060)
©2010 ArvinMeritor, Inc.

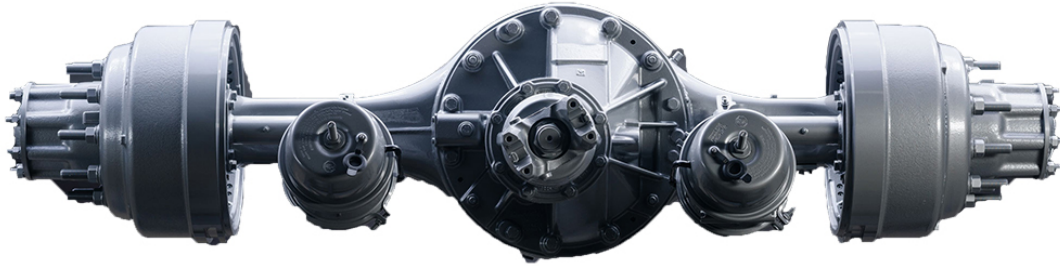

Meritor Axle Model RT-40160 - RD-23160 - Carrier A-3200-J-2116

Pro Gear parts and service manual for Meritor Axle Model RT-40160 - RD-23160 - Carrier A3200J2116 to assist you in identifying the correct configuration of your Meritor Axle. This Meritor A3200J2116 axle, is available and ready for international shipping. Call today!

If you need any assistance identifying the correct Meritor axle unit for your truck or equipment, contact your Meritor axle replacement specialists at Pro Gear and Transmission.

Pro Gear stocks every part for your Meritor axle RT40160 and RD23160. We have 1000's of products in shop that are ready to ship internationally for your next project.

For parts or service contact the Meritor specialists at Pro Gear & Transmission, Inc.

 CALL US

 EMAIL US

 VISIT MODEL PAGE

 VISIT ONLINE STORE