



## **Meritor Axle Model RT-40160 - RR-29160 - Carrier A-3200-E-2137**

Pro Gear parts and service manual for Meritor Axle Model RT-40160 - RR-29160 - Carrier A3200E2137 to assist you in identifying the correct configuration of your Meritor Axle. This Meritor A3200E2137 axle, is available and ready for international shipping. Call today!

If you need any assistance identifying the correct Meritor axle unit for your truck or equipment, contact your Meritor axle replacement specialists at Pro Gear and Transmission.

Pro Gear stocks every part for your Meritor axle RT40160 and RR29160. We have 1000's of products in shop that are ready to ship internationally for your next project.

For parts or service contact the Meritor specialists at Pro Gear & Transmission, Inc.

 CALL US

 EMAIL US

 VISIT MODEL PAGE

 VISIT ONLINE STORE



**MERITOR**<sup>®</sup>

An **ArvinMeritor**<sup>™</sup> Brand

**160, 161 AND 164 SERIES  
DRIVE AXLE PARTS**



PB-9250  
Revised 09-10

# FIGURE 1 FORWARD CARRIERS OF TANDEM AXLES (USE WITH CHART 1)

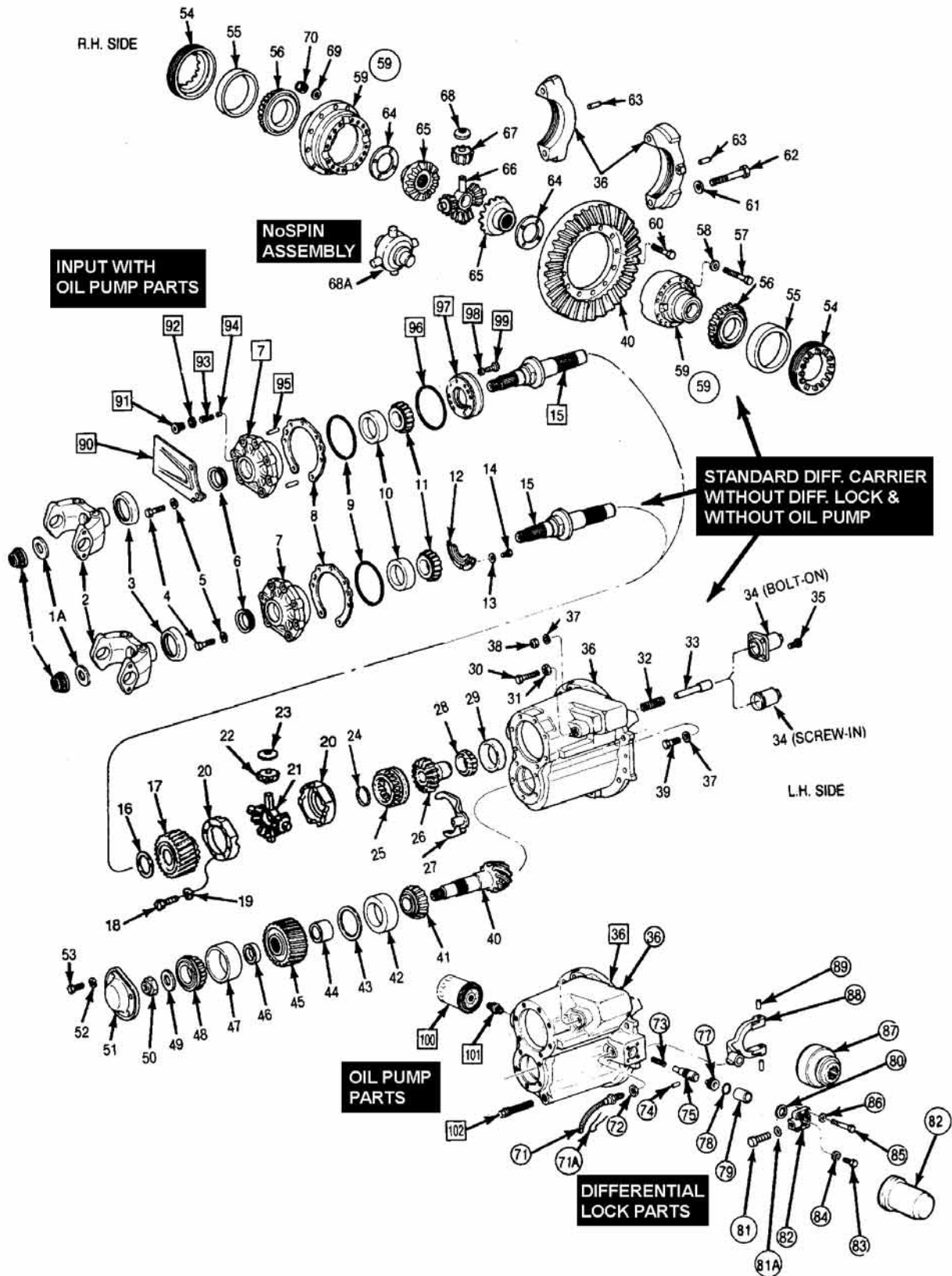

• Circled ○ numbers are diff. lock parts or parts that change when diff. lock is added.

• Squared □ numbers are oil pump parts or parts that change when oil pump is added.

# FIGURE 2 CARRIERS FOR SINGLE AXLES AND REAR OF TANDEM AXLES (USE WITH CHART 2)

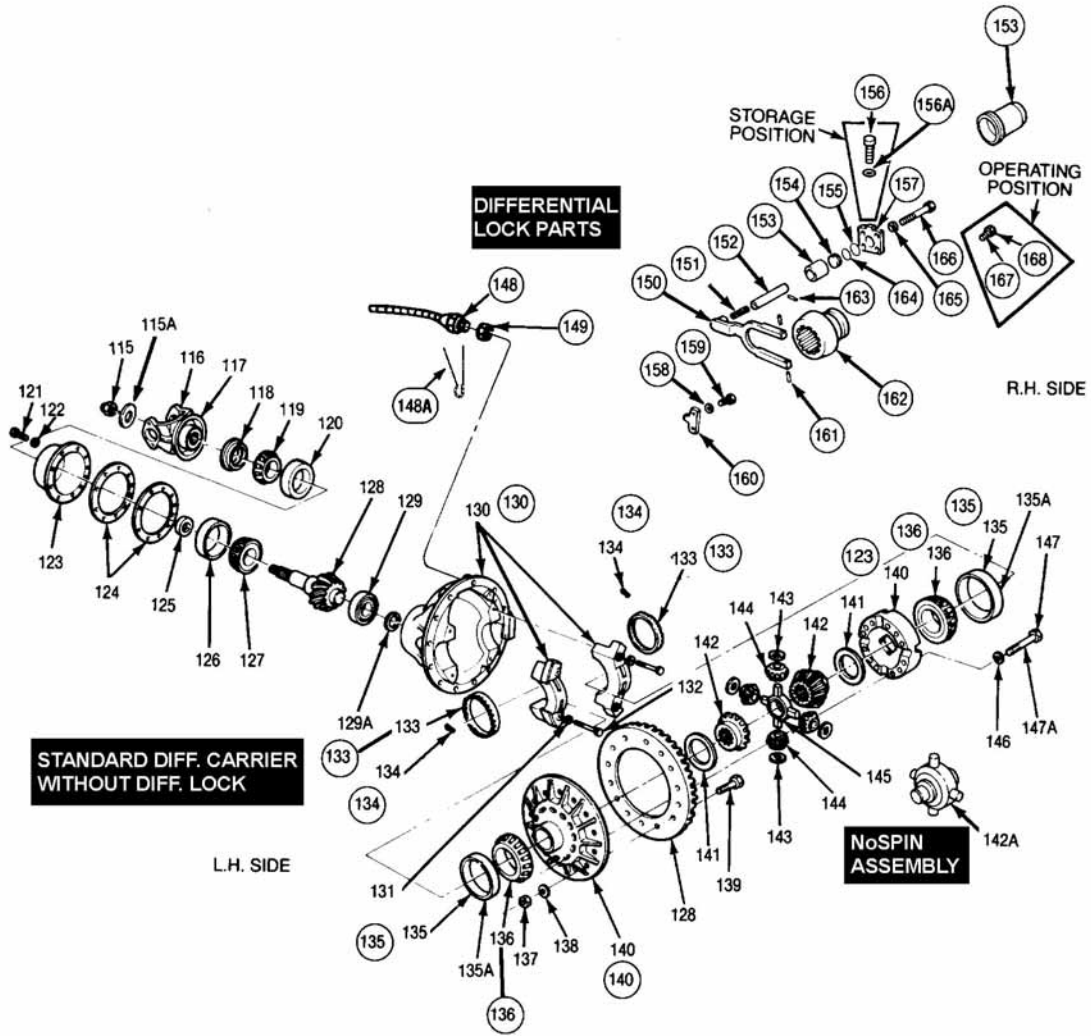

• Circled  $\bigcirc$  numbers are diff. lock parts or parts that change when diff. lock is added.

# SUPPLEMENTAL DRAWING CARRIERS WITH INTERNAL A.B.S.



• Circled O numbers are Forward Axle Assembly parts.

# REAR DRIVE AXLES

## Model Numbers and Designations

Axle models are identified by a letter and number system.

The letters and numbers give important information about the specific axle model.

The first seven positions of the designation identify a basic axle model, while the second group of letters and numbers identify particular specifications.



### NOTE 1:

If a complete axle designation is not required, use the first seven positions of the model designation to identify the basic axle model.

### EXAMPLES OF BASIC AXLE MODELS:

**RS 17 140** - Single Rear Drive, 17,000 lb., Single Speed, 15" Ring Gear, 140 Carrier Model.

**RT 48 380** - Tandem Drive Axle Set, 48,000 lb., Helical Double Reduction, 19.62" Ring Gear, 380 Carrier Model.

**RZ 60 164** - Tridem Drive Axle Set, 60,000 lb., Single Speed, Includes a 150 Series Forward Rear or First Axle and a 145 Series Tandem Axle Set as the Second and Third Axles.

### NOTE 2, FOR TRIDEM AXLES ONLY:

For a Tridem Drive Axle Set (RZ), the number in the sixth position designates the carrier in the first axle. The number in the seventh position designates the carriers in the second and third axles.

### NOTE 3:

Some axle designations or specifications do not have a hub type code.

# HOW TO USE THIS CATALOG

- There are 36 basic carriers covered in this catalog:

|             |             |             |             |             |
|-------------|-------------|-------------|-------------|-------------|
| 3200-C-1511 | 3200-P-1706 | 3200-C-1823 | 3200-V-1894 | 3200-K-2117 |
| 3200-Z-1560 | 3200-R-1708 | 3200-E-1825 | 3200-W-1895 | 3200-L-2118 |
| 3200-P-1628 | 3200-V-1712 | 3200-Q-1837 | 3200-Y-1897 | 3200-J-2137 |
| 3200-J-1648 | 3200-W-1713 | 3200-H-1854 | 3200-J-1908 | 3200-K-2138 |
| 3200-T-1658 | 3200-X-1818 | 3200-J-1856 | 3200-K-1909 |             |
| 3200-V-1660 | 3200-Y-1819 | 3200-K-1857 | 3200-D-1928 |             |
| 3200-K-1701 | 3200-Z-1820 | 3200-L-1858 | 3200-E-1929 |             |
| 3200-M-1703 | 3200-A-1821 | 3200-T-1892 | 3200-J-2116 |             |

Major assembly differences in a carrier are indicated by the different assembly level numbers in front of the base carrier number, for example, A1-3200-V-1894 and A4-3200-V-1894. The Axle Models-Carriers-Features chart inside this front cover lists all the variations covered in this book.

Note: The carriers listed in this catalog do not include yokes. A yoke is a major assembly difference, therefore, a carrier sold with a yoke has a different assembly level number than the same carrier without the yoke.

- The charts for carriers, output shafts, and housings include the following information:

- An exploded view of each assembly, keyed to the parts list
- A description of each part
- Parts sold as assemblies that include other parts
- Which carriers or axle models the part is used on
- The quantity of the part used on the carrier or axle
- The part number of each item
- Whether the part is available in a kit

- **Carrier parts:**

Determine which chart and figure (1 or 2) applies to your carrier by using the following sources of information.

- Identification tag installed on the carrier
- Axle Models-Carriers-Features Chart
- Pictures and descriptions of the carriers inside the front cover and at the beginning of Chart 1 and Chart 2

- **Output (thru) shafts:**

This chart covers the output shafts for the forward axles of all tandems. Note that the output shaft assembly or its components are only sold as separate items. The output shaft is not included with the purchase of a carrier or housing.

- **Housing Assemblies and Wheel End Parts:**

This chart covers the housing assemblies and wheel end parts for all axles. The parts are listed according to axle models that are used on 160, 161 and 164 series axles.

- **Axle shafts:**

The axle shafts are grouped in sets (L.H. and R.H.) according to the axle models they are used on. Many axle shafts are used on more than one axle model. The axle shafts are also listed by part number with dimensions.

- **Yokes and Flanges:**

There are four charts that cover full round bearing yokes, wing bearing yokes, Easy Service yokes, and flanges. Each chart lists the yokes or flanges used on each model. The yokes and flanges are listed by dimensions.

- **Kits:**

The first chart in this section lists all the kits available for each axle model and carrier. Following that chart, the kits are sequenced according to the kit number and list the contents of each kit.

- **Numerical Parts List:**

This section lists every part number along with the page(s) on which the part is listed.

# AXLE MODELS - CARRIERS - FEATURES

## 160, 161 & 164

### Single Reduction Axles (Single & Tandem)

| AXLE MODELS<br>(All models shown below are<br>2.38"-46 axle spline) |             | CARRIERS          | INTER-AXLE<br>DIFF. | MAIN<br>DIFF.<br>LOCK | NO-<br>SPIN®<br>DIFF. | OIL<br>PUMP | CARRIER<br>PARTS<br>CHART NO. |   |
|---|-------------|-------------------|---------------------|-----------------------|-----------------------|-------------|-------------------------------|---|
| RS-21160/161  | Single Axle | A1-3200-P-1706    |                     |                       |                       |             | 2                             |   |
| RS-23160/161  |             | A-3200-E-2137 (1) |                     |                       |                       |             | 2                             |   |
| RS-24160/161  |             | A-3200-F-2138 (1) |                     | ●                     | ●                     |             | 2                             |   |
| RS-25160/161  |             |                   |                     |                       |                       |             |                               |   |
| RS-26160/161  |             |                   |                     |                       |                       |             |                               |   |
| RT-40160  | Forward     | RD-20160          | A6-3200-Q-1837 (2)  | ●                     |                       |             | 1                             |   |
| RT-46160  |             | RD-23160          | A-3200-J-2116 (1)   | ●                     |                       |             | 1                             |   |
| RT-46164  |             | RD-23164          | A1-3200-J-1908 (2)  | ●                     | ●                     |             | 1                             |   |
| RT-50160  |             | RD-25160          | A3-3200-L-2118 (1)  | ●                     | ●                     |             | 1                             |   |
| RT-50164  |             | RD-26160          | A1-3200-J-2116 (1)  | ●                     |                       | ●           | 1                             |   |
| RT-52160  |             | RP-20160          | A1-3200-K-1909 (2)  | ●                     |                       | ●           | 1                             |   |
| RT-52164  |             | RP-23160          | A-3200-K-2117 (1)   | ●                     |                       | ●           | 1                             |   |
|   |             | RP-23164          | A5-3200-K-1909 (2)  | ●                     | ●                     | ●           | 1                             |   |
|   |             | RP-25160          | A3-3200-K-2117 (1)  | ●                     | ●                     | ●           | 1                             |   |
|   |             | RP-26160          | A1-3200-K-2117 (1)  | ●                     |                       | ●           | ●                             | 1 |
|   |             | RP-29160          |                     |                       |                       |             |                               |   |
|   |             | Rear              | RR-20160            | A1-3200-P-1706        |                       |             |                               | 2 |
|   |             |                   | RR-23160            | A-3200-E-2137 (1)     |                       |             |                               | 2 |
|   |             |                   | RR-23164            | A1-3200-A-1821 (2)    |                       |             |                               | 2 |
|   | RR-25160    |                   | A1-3200-T-1892      |                       | ●                     |             | 2                             |   |
|   | RR-26160    |                   | A-3200-F-2138 (1)   |                       | ●                     |             | 2                             |   |
|   | RR-29160    |                   | A1-3200-D-1928 (2)  |                       | ●                     |             | 2                             |   |
|   |             |                   | A17-3200-P-1706     |                       |                       | ●           |                               | 2 |

### REMAN AXLE MODEL OFFERING

| REMAN AXLE<br>DESIGNATION | OEM PRODUCTION<br>DESIGNATION                  | COMMENTS  |
|---------------------------|--|---|
| RD23160/164               | RT46/50/52160 Forward<br>RT46/50/52164 Forward |   |
| RP23160/164               | RT46/50/52160 Forward<br>RT46/50/52164 Forward | With pump   |
| RDL23160/164              | RT46/50/52160 Forward<br>RT46/50/52164 Forward | With main diff. lock  |
| RPL23160/164              | RT46/50/52160 Forward<br>RT46/50/52164 Forward | With pump and main diff. lock   |
| RR23160/164               | RT46/50/52160 Rear<br>RT46/50/52164 Rear       | Can be used as a single axle replacement for RS23160  |
| RRL23160/164              | RT46/50/52160 Rear<br>RT46/50/52164 Rear       | With main diff. lock, can be used as a single axle replacement for RS23160 with main diff. lock |

(1) Tapered dowel

(2) With thrust screw



# STANDARD CARRIER SUPERCESSION LIST

| ORIGINAL PART NUMBER | REPLACEMENT PART NUMBER |
|----------------------|-------------------------|
| A15-3200-C-1511      | A1-3200-Y-1897 *        |
| A17-3200-C-1511      | A4-3200-Y-1897 *        |
| A24-3200-Z-1560      | A17-3200-P-1706         |
| A26-3200-Z-1560      | A1-3200-P-1706          |
| A27-3200-Z-1560      | A1-3200-T-1892          |
| A9-3200-P-1628       | A1-3200-V-1894          |
| A12-3200-P-1628      | A4-3200-V-1894          |
| A14-3200-P-1628      | A9-3200-V-1894          |
| A1-3200-J-1648       | A1-3200-X-1818          |
| A4-3200-J-1648       | A4-3200-X-1818          |
| A1-3200-T-1658       | A1-3200-P-1706          |
| A13-3200-T-1658      | A17-3200-P-1706         |
| A1-3200-V-1660       | A1-3200-T-1892          |
| A1-3200-K-1701       | A1-3200-V-1894          |
| A4-3200-K-1701       | A4-3200-V-1894          |
| A6-3200-K-1701       | A9-3200-V-1894          |
| A1-3200-M-1703       | A1-3200-X-1818          |
| A4-3200-M-1703       | A4-3200-X-1818          |
| A1-3200-P-1706       | B57-3200-P-1706         |
| A17-3200-P-1706      | B58-3200-P-1706         |
| A1-3200-R-1708       | A1-3200-T-1892          |

| ORIGINAL PART NUMBER | REPLACEMENT PART NUMBER |
|----------------------|-------------------------|
| A1-3200-V-1712       | A1-3200-Y-1897 *        |
| A4-3200-V-1712       | A4-3200-Y-1897 *        |
| A11-3200-V-1712      | A11-3200-E-1825         |
| A1-3200-W-1713       | A1-3200-W-1895          |
| A1-3200-X-1818       | A-3200-J-2116S          |
| A4-3200-X-1818       | A1-3200-J-2116S         |
| A1-3200-Y-1819       | A1-3200-W-1895          |
| A1-3200-Z-1820       | A1-3200-V-1894          |
| A4-3200-Z-1820       | A4-3200-V-1894          |
| A6-3200-Z-1820       | A9-3200-V-1894          |
| A1-3200-C-1823       | A1-3200-T-1892          |
| A1-3200-E-1825       | A1-3200-Y-1897 *        |
| A4-3200-E-1825       | A4-3200-Y-1897 *        |
| A1-3200-T-1892       | A34-3200-T-1892         |
| A1-3200-V-1894       | A3-3200-K-2117S         |
| A4-3200-V-1894       | A-3200-K-2117S          |
| A9-3200-V-1894       | A1-3200-K-2117S         |
| A1-3200-W-1895       | A3-3200-L-2118S         |
| A1-3200-Y-1897       | A23-3200-Y-1897 *       |
| A4-3200-Y-1897       | A22-3200-Y-1897 *       |

The part number supercessions listed here reflect product improvements made in several key areas. Several of these product improvements are non-interchangeable at the component level, in these cases kits have been developed to ease your transition to the new designs.

With the exception of reverse shift carriers built for Navistar, all carriers equipped with driver controlled main differential lock now have a screw in shift cylinder. The Interaxle differential shift cylinder for these carriers is also a screw in type.

\* No Longer Available - can use steel (malleable) version.

# TABLE OF CONTENTS

|  | PAGE |
|--|------|
| Forward Carriers of Tandem Axles.....                    | 2    |
| Carriers for Single Axles and Rears of Tandem Axles..... | 8    |
| Output (Thru) Shaft Assembly Parts.....                  | 14   |
| Housing Assemblies and Wheel End Parts.....              | 15   |
| Axle Shafts.....   | 16   |
| Yokes and Flanges -                                      |      |
| Full Round Bearing Yokes.....                            | 19   |
| Wing Bearing Yokes.....                                  | 20   |
| Easy Service Yokes.....                                  | 21   |
| Companion Flanges.....                                   | 22   |
| Axle Model to Carrier to Kit Cross Reference.....        | 23   |
| Kits.....  | 28   |
| Numerical Parts Listing.....                             | 42   |

***XpresswayPlus.ArvinMeritor.com***

Don't forget about using *XpresswayPlus* for:

- Ordering parts online
- Order status
- Price and availability
- Invoice Lookup
- Parts Catalog
- Online e-mail or phone numbers for Customer Service, Information Services, Marketing, Catalog, and eSupport



**XpresswayPlus.ArvinMeritor.com**  
For all of your parts-ordering needs

- Reference Library
- The Company Store
- Literature
- Dealer/Distributor locator

XpresswayPLUS is easy to use, can reduce phone calls, and save you valuable time.

# CHART 1

## FORWARD CARRIERS OF TANDEM AXLES

(Use with Figure 1, Inside Front Cover)

### VISUAL IDENTIFICATION OF FORWARD CARRIERS

|  |  |
|--|--|
| <p style="text-align: center;">IAD SHIFTER AND DIFF. LOCK -<br/>BOLT ON FOR 1628, 1701<br/>SCREW-IN FOR 1820, 1894, 1909, 2117</p>  <p style="text-align: center;">OIL FILTER</p> <p style="text-align: right;">DIFF. LOCK</p> <p style="text-align: center;">FORWARD CARRIERS WITH IAD,<br/>DIFF. LOCK AND OIL PUMP<br/>3200-P-1628, 3200-K-1701, 3200-Z-1820,<br/>3200-V-1894, 3200-K-1909, 3200-K-2117</p> | <p style="text-align: center;">IAD SHIFTER AND DIFF. LOCK -<br/>BOLT ON FOR 1713<br/>SCREW-IN FOR 1819, 1895, 1908, 2118</p>  <p style="text-align: center;">NO OIL FILTER</p> <p style="text-align: right;">DIFF. LOCK</p> <p style="text-align: center;">FORWARD CARRIERS WITH IAD AND<br/>DIFF. LOCK WITHOUT OIL PUMP<br/>3200-W-1713, 3200-Y-1819, 3200-W-1895,<br/>3200-J-1908, 3200-L-2118</p>         |
| <p style="text-align: center;">IAD SHIFTER -<br/>SCREW-IN FOR 1820, 1858, 1894,<br/>1909, 2117</p>  <p style="text-align: center;">OIL FILTER</p> <p style="text-align: right;">NO DIFF. LOCK</p> <p style="text-align: center;">FORWARD CARRIERS WITH IAD AND<br/>OIL PUMP WITHOUT DIFF. LOCK<br/>3200-Z-1820, 3200-L-1858, 3200-V-1894,<br/>3200-K-1909, 3200-K-2117</p>                                  | <p style="text-align: center;">IAD SHIFTER -<br/>BOLT ON FOR 1648, 1703<br/>SCREW-IN FOR 1818, 1837, 1857, 2116</p>  <p style="text-align: center;">NO OIL FILTER</p> <p style="text-align: right;">NO DIFF. LOCK</p> <p style="text-align: center;">FORWARD CARRIERS WITH IAD<br/>WITHOUT DIFF. LOCK OR OIL PUMP<br/>3200-J-1648, 3200-M-1703, 3200-X-1818,<br/>3200-Q-1837, 3200-K-1857, 3200-J-2116</p> |

The following carriers are equipped with a thrust screw: 3200-Q-1837, 3200-K-1909, 3200-J-1908.

The following carriers are machined for Internal ABS Sensors: 3200-L-1857, 3200-L-1858.

# FORWARD CARRIERS OF TANDEM AXLES

| ITEM                      | DESCRIPTION  | REMARKS                                      | CARRIER   | QTY                                       | PART NUMBER     |                             |
|---------------------------|--|--|---|---|-----------------|-----------------------------|
| 1                         | Nut - input yoke & shaft   |  | Included in KIT 2826  | 1   | 40-X-1233       |                             |
| 1A                        | Washer - input nut   |  |   | 1   | 1229-N-1730     |                             |
| 2, 3                      | Yoke & deflector assembly - input                                |  |   | 1   | SEE YOKE CHARTS |                             |
| 4                         | Capscrew - input bearing cage                                    |  |   | 7   | MS-212040-2     |                             |
| 5                         | Washer - input bearing cage                                      |  |   | 7   | MWA-512         |                             |
| 6                         | Seal & sleeve assembly - input shaft                             |  |   | 1   | A1-1205-X-2728  |                             |
| 7, 10                     | Bearing, cage & cup assy. - input                                |  | All less pump   | 1   | A-3226-S-1137   |                             |
|                           |  |  | All with pump   |   | A-3226-H-1126   |                             |
| 8                         | Shims - input bearing cage                                       | .003"/.076mm<br>.005"/.127mm<br>.010"/.254mm | Included in KIT 2429  | Use as req.                               | 2203-K-9241     |                             |
|                           |  |  |   |   | 2203-L-9242     |                             |
|                           |  |  |   |   | 2203-M-9243     |                             |
| 9                         | O-ring - input bearing cage                                      |  |   | 1   | 5-X-1343        |                             |
| 10                        | Cup - input shaft bearing  |  |   | 1   | HM813810        |                             |
| 11                        | Cone - input shaft bearing                                       |  |   | 1   | HM813843        |                             |
| 12                        | Baffle - oil   | Use without oil pump                         |   | 1   | 3221-P-1004     |                             |
| 13                        | Washer - oil baffle  |  |   | 3   | 1229-E-1669     |                             |
| 14                        | Capscrew - oil baffle  |  |   | 3   | MS-208016-1     |                             |
| 15, 1                     | Input shaft & nut assembly<br>Input shaft, nut, ball & pin assy. |  | Carriers with pump  | All less pump                             | 1               | A-3297-T-1606               |
|                           |  | All others                                   |   |   | A1-3297-S-1605  |                             |
|                           |  | For old style A1-3297-H-1022 input shaft     |   |   | KIT 2624        |                             |
| 16                        | Thrust washer - helical drive gear                               | Included in KIT 2796                         |   | 1   | 1229-S-4985     |                             |
| 17                        | Gear - helical drive gear  |  |   | 1   | 3892-T-4934     |                             |
| 18                        | Capscrew - inter-axle diff. case                                 |  |   | 8   | MS-210045A-1    |                             |
| 19                        | Washer - inter-axle diff. case                                   |  |   | 8   | 1229-K-1597     |                             |
| 20, 18, 19                | Case assembly - inter-axle                                       |  |   | After 10/00                               | 1               | A5-3235-A-2393              |
|                           |  |  |   | Prior to 10/00.<br>Includes Items 25 & 27 |                 | A1-3235-A-2393              |
| 20,18, 19, 21, 22, 23, 27 | Diff. case & pinion nest assy - inter-axle                       |  |   | Includes Items 25 & 27                    | 1               | A3-3235-A-2393              |
| 21                        | Spider (cross) - inter-axle diff.                                |  |   | Included in KIT 2248                      | 1               | 3278-N-300                  |
| 22                        | Pinion gear - inter-axle diff.                                   |  |   |   | 4               | 2233-K-245                  |
| 23                        | Thrust washer - inter-axle diff. pinion                          |  |   | 4   | 1229-Q-2929     |                             |
| 24                        | Snap ring - inter-axle diff.                                     |  |   | 1   | 2297-S-5349     |                             |
| 25                        | Clutch collar - inter-axle diff.                                 | Included in KIT 2796                         | After 10/00   | 1   | 3107-P-1212     |                             |
|                           |  |  | Prior to 10/00.<br>Includes Items 25 & 27                   |   | A1-3235-A-2393  |                             |
| 26                        | Side gear - inter-axle diff., rear                               |  |   | 1   | 2234-T-1190     |                             |
| 27                        | Shift fork - inter-axle diff.                                    |  |   | 1   | 3296-B-1328     |                             |
| 28                        | Cone - rear side gear bearing                                    |  |   | 1   | JLM714149       |                             |
| 29                        | Cup - rear side gear bearing                                     |  |   | 1   | JLM714110       |                             |
| 30                        | Adjusting screw - shift shaft                                    |  |   | 1   | 41-X-1208       |                             |
| 31                        | Jam nut - adjusting screw  |  |   | 1   | MN-312-1        |                             |
| 32                        | Spring - shift shaft return                                      |  |   | 1   | 2258-U-411      |                             |
| 33                        | Shift shaft - inter-axle diff.                                   |  |   | 1   | KIT 2825        |                             |
| 34                        | Shift assy. - inter-axle diff. air                               | Screw-in style                               |   | 1   | KIT 2825        |                             |
|                           |  | Bolt-on style                                |   |   | A-3261-L-350    |                             |
| 35                        | Capscrew - air shift assembly                                    | Bolt-on style                                |   | 4   | 10-X-1334       |                             |
| 36, 61, 62                | Differential carrier & cap assembly                              | Less pump,<br>Less diff. lock                | Ratios - 3.07, 3.21, 3.42, 3.57, 3.73                       | 3200-J-1648                               | 1               | KIT 2644                    |
|                           |  |  | Ratios - 3.91, 4.10, 4.30, 4.56                             |   | Original design |                             |
|                           |  |  | Ratios - 4.89, 5.38, 5.63, 6.14, 6.43, 6.83, 7.17           |   |                 |                             |
|                           |  |  | Internal ABS  | 3200-K-1857                               |                 | A2-3200-K-1857              |
|                           |  |  | New differential bearing                                    | 3200-M-1703                               |                 | KIT 2618                    |
|                           |  |  | Screw-in IAD shifter, w/thrust screw                        | 3200-Q-1837                               |                 | A2-3200-Q-1837              |
|                           |  |  | Screw-in IAD shifter  | 3200-X-1818, 3200-J-2116                  |                 | A2-3200-J-2116S             |
|                           |  | Less pump,<br>With diff. lock                | Screw-in IAD & main diff. shift cylinder, with thrust screw | 3200-J-1908                               |                 | A2-3200-J-1908              |
|                           |  |  | Original design   | 3200-W-1713                               |                 | No Longer Available         |
|                           |  |  | Screw in IAD & main diff. shift cyl.                        | 3200-W-1895, 3200-L-2118                  |                 | A2-3200-L-2118S             |
|                           |  | With pump,<br>Less diff. lock                | Screw-in IAD shifter  | 3200-Y-1819                               |                 | KIT 2764                    |
|                           |  |  | Screw-in IAD shifter, w/thrust screw                        | 3200-K-1909                               |                 | A2-3200-K-1909              |
|                           |  |  | Internal ABS  | 3200-L-1858                               |                 | A2-3200-L-1858              |
|                           |  |  | Screw-in IAD shifter  | 3200-V-1894, 3200-K-2117<br>3200-Z-1820   |                 | A2-3200-K-2117S<br>KIT 2766 |

# FORWARD CARRIERS OF TANDEM AXLES

| ITEM                 | DESCRIPTION   |                               | REMARKS   | CARRIER                        | QTY           | PART NUMBER     |
|----------------------|---|-------------------------------|---|--------------------------------|---------------|-----------------|
| 36, 61, 62<br>(Cont) | Differential carrier & cap assembly                 | With pump,<br>With diff. lock | New differential bearing                                    | 3200-K-1701                    | 1             | KIT 2616        |
|                      |   |                               | Screw-in IAD & main diff. shift cylinder, with thrust screw | 3200-K-1909                    |               | A2-3200-K-1909  |
|                      |   |                               | Ratios - 3.07, 3.21, 3.42, 3.58, 3.73                       | 3200-P-1628<br>Original design |               | KIT 2640        |
|                      |   |                               | Ratios - 3.91, 4.10, 4.30, 4.56                             |                                |               | KIT 2640A       |
|                      |   |                               | Ratios - 4.89, 5.38, 5.63, 6.14, 6.43, 6.83, 7.17           |                                |               | KIT 2640B       |
|                      |   |                               | Screw-in IAD & main diff. shift cylinder                    | 3200-V-1894<br>3200-K-2117     |               | A2-3200-K-2117S |
| Screw-in IAD shifter | 3200-Z-1820   | KIT 2763                      |   |                                |               |                 |
| 36A                  | Thrust screw (not shown)                            |                               |   |                                | 1             | 15-X-1167       |
| 36B                  | Jam nut (not shown)                                 |                               |   |                                | 1             | 1227-D-472      |
| 37                   | Washer - carrier to housing                         |                               | Ref. only - not included with any carrier                   |                                | 12            | 1229-W-1557     |
| 38                   | Nut - carrier to housing stud                       |                               |   |                                | 2             | NL-110-1        |
| 39                   | Capscrew - carrier to housing                       | Long                          |   |                                | 3             | 10-X-1599       |
|                      |   | Short                         |   |                                | 7             | 10-X-1594       |
| 40, 50               | Drive gear pinion & nut assembly                    |                               | 3.07 Ratio  |                                | Use 1 as req. | A-39654-1       |
|                      |   |                               | 3.21 Ratio  |                                |               | A-39656-1       |
|                      |   |                               | 3.42 Ratio  |                                |               | A-39658-1       |
|                      |   |                               | 3.58 Ratio  |                                |               | A-39660-1       |
|                      |   |                               | 3.73 Ratio  |                                |               | A-39662-1       |
|                      |   |                               | 3.91 Ratio  |                                |               | A-39876-1       |
|                      |   |                               | 4.10 Ratio  |                                |               | A-39878-1       |
|                      |   |                               | 4.30 Ratio  |                                |               | A-39880-1       |
|                      |   |                               | 4.56 Ratio  |                                |               | A-39882-1       |
|                      |   |                               | 4.89 Ratio  |                                |               | A-39664-1       |
|                      |   |                               | 5.38 Ratio  |                                |               | A-39666-1       |
|                      |   |                               | 5.63 Ratio  |                                |               | A-39672-1       |
|                      |   |                               | 6.14 Ratio  |                                |               | A-39674-1       |
|                      |   |                               | 6.43 Ratio  |                                |               | A-39892-1       |
| 6.83 Ratio           | A-41064-1   |                               |   |                                |               |                 |
| 7.17 Ratio           | A-39896-1   |                               |   |                                |               |                 |
| 41                   | Cone - drive pinion inner bearing                   |                               |   |                                | 1             | H715343         |
| 42                   | Cup - drive pinion inner bearing                    |                               |   |                                | 1             | H715311         |
| 43                   | Shims - pinion inner bearing cup                    | .003"/.076mm                  | Included in KIT 2429  |                                | Use as req.   | 2203-F-2788     |
|                      |   | .005"/.127mm                  |   |                                |               | 2203-G-2789     |
|                      |   | .010"/.254mm                  |   |                                |               | 2203-H-2790     |
| 44                   | Spacer - pinion bearing inner                       |                               |   |                                | 1             | 1244-W-1765     |
| 45                   | Gear - helical driven                               |                               |   |                                | 1             | 3892-U-4909     |
| 46                   | Spacers - pinion bearing outer (variable thickness) | .451"/11.45mm                 | Included in KIT 2397  |                                | Use 2 as req. | 2203-V-9824     |
|                      |   | .452"/11.48mm                 |   |                                |               | 2203-W-9825     |
|                      |   | .453"/11.50mm                 |   |                                |               | 2203-X-9826     |
|                      |   | .454"/11.53mm                 |   |                                |               | 2203-Y-9827     |
|                      |   | .455"/11.55mm                 |   |                                |               | 2203-Z-9828     |
|                      |   | .459"/11.65mm                 |   |                                |               | 2203-A-9829     |
|                      |   | .463"/11.75mm                 |   |                                |               | 2203-B-9830     |
|                      |   | .467"/11.85mm                 |   |                                |               | 2203-C-9831     |
|                      |   | .470"/11.95mm                 |   |                                |               | 2203-D-9832     |
|                      |   | .474"/12.05mm                 |   |                                |               | 2203-E-9833     |
|                      |   | .478"/12.15mm                 |   |                                |               | 2203-F-9834     |
|                      |   | .482"/12.25mm                 |   |                                |               | 2203-G-9835     |
|                      |   | .483"/12.28mm                 |   |                                |               | 2203-H-9836     |
|                      |   | .484"/12.30mm                 |   |                                |               | 2203-J-9838     |
| .485"/12.33mm        | 2203-K-9839   |                               |   |                                |               |                 |
| .486"/12.35mm        | 2203-L-9840   |                               |   |                                |               |                 |
| 47                   | Cup - drive pinion outer bearing                    |                               |   |                                | 1             | 65500           |
| 48                   | Cone - drive pinion outer bearing                   |                               |   |                                | 1             | 65237           |
| 49                   | Washer - drive pinion                               |                               |   |                                | 1             | 1229-G-4063     |
| 50                   | Nut - drive pinion                                  |                               |   |                                | 1             | 40-X-1145       |
| 51                   | Cover - drive pinion                                |                               |   |                                | 1             | 3266-C-1095     |
| 52                   | Washer - drive pinion cover                         |                               |   |                                | 5             | 1229-K-1597     |
| 53                   | Capscrew - drive pinion cover                       |                               |   |                                | 5             | MS-210020-1     |
| 54                   | Adjusting rings - diff. bearing                     |                               | Both sides  | 1628, 1648 carriers            | 2             | 2214-U-1269     |
|                      |   |                               |   | 3200-K-1857 (ABS)              |               | 2214-Z-1144     |

# FORWARD CARRIERS OF TANDEM AXLES

| ITEM                           | DESCRIPTION                                       | REMARKS   | CARRIER   | QTY               | PART NUMBER                   |
|--------------------------------|---|---|---|-------------------|-------------------------------|
| 54 (Cont)                      | Adjusting rings - diff. bearing (Cont)            | LH side   | 3200-L-1858 (ABS)   | 1                 | KIT 2830                      |
|                                |   | RH side   |   |                   | 2214-Z-1144                   |
|                                |   | LH side   | 3200-Z-1820, 3200-V-1894,<br>3200-W-1895  |                   | 2214-J-1128                   |
|                                |   | RH side   |   |                   | 2214-G-1125                   |
|                                |   |   | Both sides  | All other non-ABS | 2                             |
| 55                             | Cups - diff. bearing                              | Both sides  | 1628, 1648 carriers   | 2                 | A1-1228-B-600                 |
|                                |   |   | 1703, 1818, 1837 carriers   |                   | 592A                          |
|                                |   | LH side   | All others  | 1                 | 52618                         |
|                                |   | RH side   |   |                   | 592A                          |
| 56                             | Cones - diff. bearing                             | Both sides  | 1628, 1648 carriers   | 2                 | A1-1228-B-600                 |
|                                |   |   | 1703, 1818, 1837 carriers   |                   | 594A                          |
|                                |   | LH side   | All others  | 1                 | 52400                         |
|                                |   | RH side   |   |                   | 594A                          |
| 57                             | Capscrew - main diff. case                        |   |   | 12                | 41-X-1275                     |
| 58                             | Washer - main diff. case                          |   |   | 12                | 1229-U-1503                   |
| 59, 57, 58                     | Case assembly - main diff.                        | Ratios - 3.07, 3.21, 3.42, 3.58, 3.73             | 3200-J-1648<br>Less diff. lock  | Use 1 as req.     | A10-3235-S-1813               |
|                                |   | Ratios - 3.91, 4.10, 4.30, 4.56                   |   |                   | A10-3235-F-1982               |
|                                |   | Ratios - 4.89, 5.38, 5.63, 6.14, 6.43, 6.83, 7.17 |   |                   | A10-3235-H-1984 <sup>23</sup> |
|                                |   | Ratios - 3.07, 3.21, 3.42, 3.58, 3.73             | 3200-K-1701, 3200-W-1713,<br>3200-Y-1819, 3200-Z-1820,<br>3200-V-1894, 3200-W-1895,<br>3200-J-1908, 3200-K-1909,<br>3200-K-2117, 3200-L-2118<br>With diff. lock |                   | A2-3235-C-2109                |
|                                |   | Ratios - 3.91, 4.10, 4.30, 4.56                   |   |                   | A2-3235-E-2111                |
|                                |   | Ratios - 4.89, 5.38, 5.63, 6.14, 6.43, 6.83, 7.17 |   |                   | A2-3235-G-2113                |
|                                |   | Ratios - 3.07, 3.21, 3.42, 3.58, 3.73             | 3200-K-1701, 3200-Z-1820,<br>3200-V-1894, 3200-K-1909,<br>3200-K-2117<br>Less diff. lock  |                   | A5-3235-C-2109                |
|                                |   | Ratios - 3.91, 4.10, 4.30, 4.56                   |   |                   | A5-3235-E-2111                |
|                                |   | Ratios - 4.89, 5.38, 5.63, 6.14, 6.43, 6.83, 7.17 |   |                   | A5-3235-G-2113                |
|                                |   | Ratios - 3.07, 3.21, 3.42, 3.58, 3.73             | 3200-M-1703, 3200-X-1818,<br>3200-Q-1837, 3200-J-2116<br>Less diff. lock  |                   | A-3235-C-2109                 |
|                                |   | Ratios - 3.91, 4.10, 4.30, 4.56                   |   |                   | A-3235-E-2111                 |
|                                |   | Ratios - 4.89, 5.38, 5.63, 6.14, 6.43, 6.83, 7.17 |   |                   | A-3235-G-2113                 |
|                                |   | Ratios - 3.07, 3.21, 3.42, 3.58, 3.73             | 3200-P-1628<br>With diff. lock  |                   | A12-3235-S-1813               |
|                                |   | Ratios - 3.91, 4.10, 4.30, 4.56                   |   |                   | A12-3235-F-1982               |
|                                |   | Ratios - 4.89, 5.38, 5.63, 6.14, 6.43, 6.83, 7.17 |   |                   | A12-3235-H-1984 <sup>23</sup> |
| 59, 57, 58, 64, 65, 66, 67, 68 | Case & nest assembly - main diff.                 | Ratios - 3.07, 3.21, 3.42, 3.58, 3.73             | 3200-J-1648<br>Less diff. lock  | Use 1 as req.     | A11-3235-S-1813               |
|                                |   | Ratios - 3.91, 4.10, 4.30, 4.56                   |   |                   | A11-3235-F-1982               |
|                                |   | Ratios - 4.89, 5.38, 5.63, 6.14, 6.43, 6.83, 7.17 |   |                   | A11-3235-H-1984 <sup>23</sup> |
|                                |   | Ratios - 3.07, 3.21, 3.42, 3.58, 3.73             | 3200-K-1701, 3200-W-1713,<br>3200-Y-1819, 3200-Z-1820,<br>3200-V-1894, 3200-W-1895,<br>3200-J-1908, 3200-K-1909,<br>3200-K-2117, 3200-L-2118<br>With diff. lock |                   | A3-3235-C-2109                |
|                                |   | Ratios - 3.91, 4.10, 4.30, 4.56                   |   |                   | A3-3235-E-2111                |
|                                |   | Ratios - 4.89, 5.38, 5.63, 6.14, 6.43, 6.83, 7.17 |   |                   | A3-3235-G-2113                |
|                                |   | Ratios - 3.07, 3.21, 3.42, 3.58, 3.73             | 3200-K-1701, 3200-Z-1820,<br>3200-V-1894, 3200-K-1909,<br>3200-K-2117<br>Less diff. lock  |                   | A6-3235-C-2109                |
|                                |   | Ratios - 3.91, 4.10, 4.30, 4.56                   |   |                   | A6-3235-E-2111                |
|                                |   | Ratios - 4.89, 5.38, 5.63, 6.14, 6.43, 6.83, 7.17 |   |                   | A6-3235-G-2113                |
|                                |   | Ratios - 3.07, 3.21, 3.42, 3.58, 3.73             | 3200-M-1703, 3200-X-1818,<br>3200-Q-1837, 3200-J-2116<br>Less diff. lock  |                   | A1-3235-C-2109                |
|                                |   | Ratios - 3.91, 4.10, 4.30, 4.56                   |   |                   | A1-3235-E-2111                |
|                                |   | Ratios - 4.89, 5.38, 5.63, 6.14, 6.43, 6.83, 7.17 |   |                   | A1-3235-G-2113                |
|                                |   | Ratios - 3.07, 3.21, 3.42, 3.58, 3.73             | 3200-P-1628<br>With diff. lock  |                   | A13-3235-S-1813               |
|                                |   | Ratios - 3.91, 4.10, 4.30, 4.56                   |   |                   | A13-3235-F-1982               |
|                                |   | Ratios - 4.89, 5.38, 5.63, 6.14, 6.43, 6.83, 7.17 |   |                   | A13-3235-H-1984 <sup>23</sup> |
| 59, 57, 58, 64, 173, 174, 175  | Case & nest assembly - main diff.                 | Ratios - 3.07, 3.21, 3.42, 3.58, 3.73             | 3200-K-1857,<br>Internal ABS,<br>Less diff. lock,<br>Less pump  | Use 1 as req.     | A2-3235-R-2176 <sup>23</sup>  |
|                                |   | Ratios - 3.91, 4.10, 4.30, 4.56                   |   |                   | A2-3235-S-2177 <sup>23</sup>  |
|                                |   | Ratios - 4.89, 5.38, 5.63, 6.14, 6.43, 6.83, 7.17 |   |                   | A2-3235-T-2178 <sup>23</sup>  |
|                                |   | Ratios - 3.07, 3.21, 3.42, 3.58, 3.73             | 3200-L-1858,<br>Internal ABS,<br>Less diff. lock,<br>With pump  |                   | A4-3235-R-2176 <sup>23</sup>  |
|                                |   | Ratios - 3.91, 4.10, 4.30, 4.56                   |   |                   | A4-3235-S-2177 <sup>23</sup>  |
|                                | Ratios - 4.89, 5.38, 5.63, 6.14, 6.43, 6.83, 7.17 |   | A4-3235-T-2178 <sup>23</sup>  |                   |                               |

23 No Longer Available – Contact Florence Specifications for assistance

# FORWARD CARRIERS OF TANDEM AXLES

| ITEM  | DESCRIPTION                            | REMARKS  | CARRIER   | QTY           | PART NUMBER                   |
|---|--|--|---|---------------|-------------------------------|
| 59, 57, 58, 68A                                   | Case & NoSpin assembly - main diff.    | Ratios - 3.07, 3.21, 3.42, 3.58, 3.73                  | 3200-J-1648   | Use 1 as req. | A14-3235-S-1813               |
|   |  | Ratios - 3.91, 4.10, 4.30, 4.56                        |   |               | A14-3235-F-1982               |
|   |  | Ratios - 4.89, 5.38, 5.63, 6.14, 6.43, 6.83, 7.17      |   |               | A14-3235-H-1984 <sup>23</sup> |
|   |  | Ratios - 3.07, 3.21, 3.42, 3.58, 3.73                  | 3200-K-1701, 3200-Z-1820, 3200-V-1894, 3200-K-1909    |               | A8-3235-C-2109                |
|   |  | Ratios - 3.91, 4.10, 4.30, 4.56                        |   |               | A8-3235-E-2111                |
|   |  | Ratios - 4.89, 5.38, 5.63, 6.14, 6.43, 6.83, 7.17      |   |               | A8-3235-G-2113                |
|   |  | Ratios - 3.07, 3.21, 3.42, 3.58, 3.73                  | 3200-M-1703, 3200-X-1818, 3200-Q-1837                 |               | A7-3235-C-2109                |
| Ratios - 3.91, 4.10, 4.30, 4.56                   | A7-3235-E-2111                         |  |   |               |                               |
| Ratios - 4.89, 5.38, 5.63, 6.14, 6.43, 6.83, 7.17 | A7-3235-G-2113                         |  |   |               |                               |
| 59, 57, 58, 173, 174, 175                         | Case assembly - main diff. (ABS ready) | Ratios - 3.07, 3.21, 3.42, 3.58, 3.73                  | 3200-K-1857, Internal ABS, Less diff. lock, Less pump | Use 1 as req. | A1-3235-R-2176 <sup>23</sup>  |
|   |  | Ratios - 3.91, 4.10, 4.30, 4.56                        |   |               | A1-3235-S-2177 <sup>23</sup>  |
|   |  | Ratios - 4.89, 5.38, 5.63, 6.14, 6.43, 6.83, 7.17      |   |               | A1-3235-T-2178 <sup>23</sup>  |
|   |  | Ratios - 3.07, 3.21, 3.42, 3.58, 3.73                  | 3200-L-1858, Internal ABS, Less diff. lock, With pump |               | A5-3235-R-2176 <sup>23</sup>  |
|   |  | Ratios - 3.91, 4.10, 4.30, 4.56                        |   |               | A5-3235-S-2177 <sup>23</sup>  |
| Ratios - 4.89, 5.38, 5.63, 6.14, 6.43, 6.83, 7.17 | A3-3235-T-2178 <sup>23</sup>           |  |   |               |                               |
| 60  | Bolt - gear to diff. case              | Included in KIT 2426                                   |   | 12            | 41-X-1276                     |
| 61  | Washer - diff. bearing cap             |  |   | 4             | 42-X-1024                     |
| 62  | Capscrew - diff. bearing cap           |  |   | 4             | 41-X-1018                     |
| 63  | Pin - adjusting ring lock              |  | ABS carriers  | 2             | 19-X-1087                     |
|   |  |  | All others  | 1             | KIT 4284                      |
| 64  | Thrust washer - side gear              | Included in KIT 2318 with spider, KIT 2341 less spider |   | 2             | 1229-L-3002                   |
| 65  | Side gear - diff.                      |  |   | 2             | 2234-C-1069                   |
| 66  | Spider - diff. (cross)                 |  |   | 1             | 3278-W-335                    |
| 67  | Gear - diff. pinion                    |  |   | 4             | 2233-M-1001                   |
| 68  | Thrust washer - diff. pinion           |  |   | 4             | 1229-K-3001                   |
| 68A   | No-Spin assembly                       |  |   | 1             | A-3230-C-1043                 |
| 69  | Washer - gear to diff. case            | Included in KIT 2426                                   |   | 12            | 1229-U-1503                   |
| 70  | Nut - gear to diff. case               |  |   | 12            | 40-X-1182                     |

## THE FOLLOWING PARTS ARE FOR MAIN DIFFERENTIAL LOCK

|           |                                    |                            |   |   |             |
|-----------|------------------------------------|----------------------------|---|---|-------------|
| 71        | DCDL switch kit                    |                            |   | 1 | KIT 4429    |
| Not Shown | Plug - DCDL switchport             | Non-DCDL applications only |   | 1 | 41-X-1022   |
| 72        | Lock nut - sensor/switch           |                            | Used on carriers with 3266-F-1020 air cyl. cover prior to 11/93 | 1 | 1227-P-1056 |
|           |                                    |                            | After 11/93   | 1 | 2258-N-1262 |
| 73        | Spring - main diff. lock           |                            | Prior to 11/93  |   | 2258-L-714  |
|           |                                    |                            | Prior to 11/93  | 1 | 43-X-1006   |
| 74        | Roll pin - spring retaining        |                            | 3200-P-1628   | 1 | 2244-Y-51   |
|           |                                    |                            | After 11/93   |   | KIT 2824    |
|           |                                    |                            | All others prior to 11/93                                       |   | 2244-L-1026 |
| 75        | Shift shaft - main diff. lock      |                            |   | 1 | 42-X-1027   |
| 76        | Washer - piston                    |                            | 3200-P-1628   | 1 | KIT 2824    |
|           |                                    |                            | After 11/93   |   | 2230-N-170  |
| 77        | Piston - main diff. lock           |                            | Prior to 11/93  |   | 5-X-1198    |
|           |                                    |                            | Prior to 11/93  |   | 5-X-1153    |
| 78        | O-ring - piston                    |                            | After 11/93   | 1 | 3196-F-32   |
|           |                                    |                            | Prior to 11/93  |   | 2208-H-944  |
| 79        | Tube - air cylinder                |                            | Prior to 11/93  | 1 | 41-X-1368   |
| 80        | Gasket - air cylinder cover        |                            | Prior to 11/93  | 1 | 41-X-1333   |
| 81        | Capscrew - manual engaging         |                            | After 11/93   |   | 5-X-521     |
|           |                                    |                            | Prior to 11/93  |   | KIT 2824    |
| 81A       | O-ring                             |                            | After 11/93   | 1 | 3266-F-1020 |
|           |                                    |                            | Prior to 11/93  |   | 1250-U-1217 |
| 82        | Cover - air cylinder               | Screw-in style             | After 11/93   |   | MS-210016-1 |
|           |                                    | Bolt-on style              | Prior to 11/93  |   | 2208-L-1000 |
| 82A       | Plug - screw-in DCDL cylinder hole | Non-DCDL applications only |   | 1 | 41-X-1364   |
| 83        | Plug - air cylinder cover          |                            | Prior to 11/93  | 1 | MWA-506     |
| 84        | Gasket - plug                      |                            | Prior to 11/93  | 1 | 3107-F-1020 |
| 85        | Capscrew - air cylinder cover      |                            | Prior to 11/93  | 4 | 3107-B-1094 |
| 86        | Washer - air cylinder cover        |                            | Prior to 11/93  | 4 |             |
| 87        | Clutch collar - main diff. lock    |                            | 3200-P-1628   | 1 |             |
|           |                                    |                            | All others  |   |             |

# FORWARD CARRIERS OF TANDEM AXLES

| ITEM | DESCRIPTION                  | REMARKS          | CARRIER        | QTY | PART NUMBER              |
|------|------------------------------|------------------|----------------|-----|--------------------------|
| 88   | Shift fork - main diff. lock | Three pc. design | 3200-Z-1560    | 1   | 3296-B-184               |
|      |                              | One pc. design   | After 11/93    |     | 3296-B-1172              |
|      |                              |                  | Prior to 11/93 |     | 3296-Y-1169 <sup>1</sup> |
| 89   | Pin - shift fork             | Three pc. design |                | 2   | 43-X-1007                |

**THE FOLLOWING PARTS ARE FOR OIL PUMP**

|     |                                     |  |   |   |               |
|-----|-------------------------------------|--|---|---|---------------|
| 90  | Shield - filter                     |  |   | 1 | 3264-N-1522   |
| 91  | Plug - oil pressure relief valve    | Eliminated on carriers<br>built after 5/97 |   | 1 | 1250-N-1080   |
| 92  | Washer - plug                       |  |   | 1 | 1229-F-4062   |
| 93  | Spring - oil pressure relief valve  |  |   | 1 | 2258-Z-1118   |
| 94  | Pressure relief valve - oil         |  |   | 1 | 2297-U-5273   |
| 95  | Dowel - input cage to oil pump      | No longer used                             |   | 2 | 1246-M-1131   |
| 96  | O-ring - oil pump                   |  |   | 1 | 5-X-1034      |
| 97  | Oil pump assembly                   |  | All others                                  | 1 | A-3303-P-1030 |
|     |                                     |  | For old style A1-3297-H-1022<br>input shaft |   | KIT 2624      |
| 98  | Washer - oil pump                   |  |   | 6 | 1229-E-1669   |
| 99  | Capscrew - oil pump                 |  |   | 6 | MS-208045-1   |
| 100 | Oil filter                          |  |   | 1 | 3280-V-8394   |
| 101 | Adaptor - oil filter                |  |   | 1 | 2297-Z-5278   |
| 102 | Screen & plug assembly - oil filter |  |   | 1 | A-2297-D-5334 |

**THE FOLLOWING PARTS ARE FOR THE CARRIERS WITH INTERNAL A.B.S. SENSORS**

|      |                                     |                   |                       |   |                 |
|------|-------------------------------------|-------------------|-----------------------|---|-----------------|
| 169  | Wave washer - adjusting ring        |                   |                       | 2 | 2258-G-1255     |
| 170  | Snap ring - connector               |                   |                       | 2 | 1229-U-4519     |
| 171  | Snap ring - adjusting ring          |                   |                       | 2 | 1229-F-4452     |
| 172  | Sensor - ABS                        | Both sides        | 3200-K-1857           | 2 | SA1-3280-X-9150 |
|      |                                     | LH side           | 3200-L-1858           | 1 | SA2-3280-X-9150 |
|      |                                     | RH side           |                       |   | SA1-3280-X-9150 |
| 172A | Plug - sensor attaching (not shown) | Pump carrier only | 3200-L-1858 (LH side) | 1 | 1250-T-1216     |
| 173  | Drive tube                          |                   |                       | 2 | 3216-G-4375     |
| 174  | Washer - drive tube                 |                   |                       | 2 | 42-X-1408       |
| 175  | Snap ring - drive tube              |                   |                       | 2 | 1229-D-4528     |

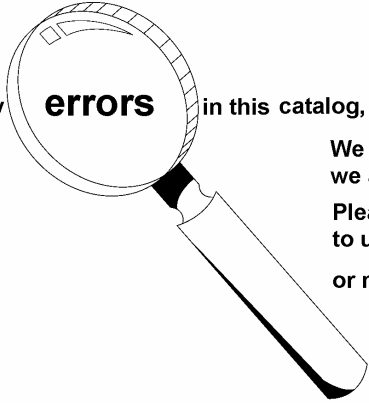

If you detect any **errors** in this catalog, please let us know.

We want the information to be as accurate as possible; we appreciate your help in making it so.

Please e-mail any comments/suggestions/corrections to us at: [catalogfeedback@arvinmeritor.com](mailto:catalogfeedback@arvinmeritor.com)

or mail to: ArvinMeritor  
attn: Catalog Dept.  
7975 Dixie Highway  
Florence, KY 41042

<sup>1</sup> Prior to 11/92 all carriers (except 3200-Z-1560) used the three piece design fork (3296-R-1084) which was replaced by 3296-Y-1169 in 11/92.



# CHART 2

## CARRIERS FOR SINGLE AXLES AND REARS OF TANDEM AXLES

(Use with Figure 2, Inside Front Cover)

### VISUAL IDENTIFICATION OF REAR CARRIERS



The following carriers are equipped with a thrust screw: 3200-A-1821, 3200-D-1928, 3200-E-1929

The following carriers are machined for Internal ABS Sensors: 3200-H-1854, 3200-J-1856

The following carriers are available with and without Diff. Lock: 3200-C-1511, 3200-Z-1560, 3200-V-1712,  
3200-E-1825, 3200-Y-1897, 3200-E-1929

# CARRIERS FOR SINGLE AXLES AND REARS OF TANDEM AXLES

| ITEM       | DESCRIPTION                         | REMARKS           | CARRIER  | QTY                    | PART NUMBER     |
|------------|-------------------------------------|-------------------|--|------------------------|-----------------|
| 115        | Nut - drive pinion                  |                   |  | 1                      | 40-X-1233       |
| 115A       | Washer - pinion nut                 |                   |  | 1                      | 1229-N-1730     |
| 116, 117   | Input yoke assembly                 |                   |  | 1                      | SEE YOKE CHARTS |
| 118        | Oil seal assembly - rear pinion     |                   |  | 1                      | A1-1205-A-2731  |
| 119        | Cone - drive pinion outer bearing   |                   |  | 1                      | HM813843        |
| 120        | Cup - drive pinion outer bearing    |                   |  | 1                      | HM813810        |
| 121        | Capscrew - pinion bearing cage      |                   |  | 8                      | MS-212045-1     |
| 122        | Washer - pinion bearing cage        |                   |  | 8                      | MWA-512         |
| 123        | Pinion bearing cage & cups assembly |                   |  | 1                      | A-3226-R-1006   |
| 124        | Shims - pinion bearing cage         | .002"/.050mm      | Included in KIT 1592   | Use as req.            | 2803-Y-2755     |
|            |                                     | .005"/.125mm      |  |                        | 2803-Z-2756     |
|            |                                     | .008"/.200mm      |  |                        | 2803-A-2757     |
|            |                                     | .020"/.500mm      |  |                        | 2803-B-2758     |
| 125        | Spacers - pinion bearing            | .250"/6.35mm      | Included in KIT 1593   | Use 2 as req.          | 2803-D-2500     |
|            |                                     | .251"/6.38mm      |  |                        | 2803-E-2501     |
|            |                                     | .252"/6.40mm      |  |                        | 2803-F-2502     |
|            |                                     | .253"/6.43mm      |  |                        | 2803-N-2510     |
|            |                                     | .254"/6.45mm      |  |                        | 2803-G-2503     |
|            |                                     | .256"/6.50mm      |  |                        | 2803-H-2504     |
|            |                                     | .260"/6.60mm      |  |                        | 2803-J-2506     |
|            |                                     | .261"/6.63mm      |  |                        | 2803-K-2507     |
|            |                                     | .262"/6.65mm      |  |                        | 2803-L-2508     |
|            |                                     | .263"/6.68mm      |  |                        | 2803-M-2509     |
| 126        | Cup - drive pinion inner bearing    |                   |  | 1                      | 9220            |
| 127        | Cone - drive pinion inner bearing   |                   |  | 1                      | 1228-V-594      |
| 128, 115   | Drive gear, pinion & nut assy.      | 2.50 ratio        | Use 1 as req.  | B-42776-1 <sup>9</sup> |                 |
|            |                                     | 2.67 ratio        |  | B-43454-1 <sup>9</sup> |                 |
|            |                                     | 2.80 ratio        |  | A-41572-1              |                 |
|            |                                     | 2.93 ratio        |  | A-41574-1              |                 |
|            |                                     | 3.07 ratio        |  | A-39898-5 <sup>3</sup> |                 |
|            |                                     | 3.21 ratio        |  | A-42002-1 <sup>2</sup> |                 |
|            |                                     | 3.42 ratio        |  | A-39900-5 <sup>3</sup> |                 |
|            |                                     | 3.58 ratio        |  | A-41990-1 <sup>2</sup> |                 |
|            |                                     | 3.73 ratio        |  | A-39902-5 <sup>3</sup> |                 |
|            |                                     | 3.91 ratio        |  | A-42004-1 <sup>2</sup> |                 |
|            |                                     | 4.10 ratio        |  | A-39904-5 <sup>3</sup> |                 |
|            |                                     | 4.30 ratio        |  | A-41992-1 <sup>2</sup> |                 |
|            |                                     | 4.56 ratio        |  | A-39906-5 <sup>3</sup> |                 |
|            |                                     | 4.89 ratio        |  | A-41994-1 <sup>2</sup> |                 |
|            |                                     | 5.13 ratio        |  | A-42466-1 <sup>2</sup> |                 |
|            |                                     | 5.29 ratio        |  | A-39884-5 <sup>4</sup> |                 |
|            |                                     | 5.38 ratio        |  | A-39886-5 <sup>4</sup> |                 |
|            |                                     | 5.63 ratio        |  | A-42006-1 <sup>2</sup> |                 |
|            |                                     | 6.14 ratio        |  | A-39888-5 <sup>4</sup> |                 |
|            |                                     | 6.43 ratio        |  | A-41996-1 <sup>2</sup> |                 |
| 6.83 ratio | A-39890-5 <sup>4</sup>              |                   |  |                        |                 |
| 7.17 ratio | A-41988-1 <sup>2</sup>              |                   |  |                        |                 |
| 129        | Spigot bearing - drive pinion       | One piece bearing | Use for carriers that have been upgraded to snap ring gearsets only<br>Use with new snap ring design<br>Use with original non-snap ring design | 1                      | 1228-Y-1221     |
|            |                                     | Two piece bearing |  | 1228-B-1042            |                 |
|            |                                     | 1                 |  | A1-1228-P-1004         |                 |

2 Quietride™ gearing.

4 Use KIT 2468 + Ratio to upgrade the 3200-Z-1560 carriers.  
Use KIT 2655 + Ratio to upgrade the 3200-C-1511 carriers.

3 For 3200-C-1511, 3200-Z-1560, 3200-T-1658 & 3200-V-1660 use -6 gearsets, except for 6.83 ratio use -2 gearset.

9 Use only in carriers made after 3/6/06.

24 No Longer Available

# CARRIERS FOR SINGLE AXLES AND REARS OF TANDEM AXLES

| ITEM  | DESCRIPTION  | REMARKS   | CARRIER  | QTY                     | PART NUMBER             |                     |
|---|--|---|--|-------------------------|-------------------------|---------------------|
| 129A  | Snap ring - spigot bearing                         | Use with 1228-B-1042 and 1228-Y-1221              |  | 1                       | 46-X-1029               |                     |
| 130, 131 & 132  | Differential carrier & cap assy.                   | Less differential lock                            | With thrust screw                                  | 3200-A-1821             | 1                       | A2-3200-A-1821      |
|   |  |   | Ratios - 3.07, 3.21, 3.42, 3.58, 3.73              | 3200-C-1511<br>Aluminum |                         | KIT 2657            |
|   |  |   | Ratios - 3.91, 4.10, 4.30, 4.56                    |                         |                         | KIT 2657A           |
|   |  |   | Ratios - 4.89, 5.38, 5.63, 6.14, 6.43, 6.83, 7.17  |                         |                         | KIT 2657B           |
|   |  |   | Aluminum   | 3200-E-1825             |                         | No Longer Available |
|   |  |   |  | 3200-E-1929             |                         | A2-3200-E-1929      |
|   |  |   | Aluminum, ABS                                      | 3200-H-1854             |                         | A2-3200-H-1854      |
|   |  |   | Internal ABS                                       | 3200-J-1856             |                         | A2-3200-J-1856      |
|   |  |   | New bearings                                       | 3200-P-1706             |                         | A2-3200-P-1706      |
|   |  |   | New bearings / tapered dowels                      | 3200-E-2137             |                         | A2-3200-E-2137      |
|   |  |   | Aluminum   | 3200-V-1712             |                         | KIT 2634            |
|   |  |   |  | 3200-Y-1897             |                         | A2-3200-Y-1897      |
|   |  | Ratios - 3.07, 3.21, 3.42, 3.58, 3.73             | 3200-Z-1560  | KIT 2642                |                         |                     |
|   |  | Ratios - 3.91, 4.10, 4.30, 4.56                   | Original design,<br>3200-T-1658<br>Wide leg design | KIT 2642A               |                         |                     |
|   |  | Ratios - 4.89, 5.38, 5.63, 6.14, 6.43, 6.83, 7.17 |  | KIT 2642B               |                         |                     |
|   |  | With differential lock                            | Ratios - 3.07, 3.21, 3.42, 3.58, 3.73              | 3200-C-1511<br>Aluminum | KIT 2658                |                     |
|   |  |   | Ratios - 3.91, 4.10, 4.30, 4.56                    |                         | KIT 2658A               |                     |
|   |  |   | Ratios - 4.89, 5.38, 5.63, 6.14, 6.43, 6.83, 7.17  |                         | KIT 2658B               |                     |
|   |  |   | Revised diff. lock                                 | 3200-C-1823             | KIT 2762                |                     |
|   |  |   | Malleable w/screw-in main diff. shifter            | 3200-D-1928             | A2-3200-D-1928          |                     |
|   |  |   | Aluminum   | 3200-E-1825             | No Longer Available     |                     |
|   |  |   | Aluminum w/screw-in main diff. shifter             | 3200-E-1929             | A2-3200-E-1929          |                     |
|   |  |   | New bearings                                       | 3200-R-1708             | KIT 2659                |                     |
|   |  |   | Malleable w/screw-in main diff. shifter            | 3200-T-1892             | A2-3200-T-1892          |                     |
| Malleable w/screw-in main diff. shifter / with tapered dowels | 3200-F-2138  |   | A2-3200-F-2138                                     |                         |                         |                     |
| Aluminum  | 3200-V-1712  |   | No Longer Available                                |                         |                         |                     |
| Aluminum w/screw-in main diff. shifter                        | 3200-Y-1897  |   | A2-3200-Y-1897                                     |                         |                         |                     |
| Ratios - 3.07, 3.21, 3.42, 3.58, 3.73                         | 3200-Z-1560  | KIT 2643  |  |                         |                         |                     |
| Ratios - 3.91, 4.10, 4.30, 4.56                               | Original design,<br>3200-V-1660<br>Wide leg design | KIT 2643A   |  |                         |                         |                     |
| Ratios - 4.89, 5.38, 5.63, 6.14, 6.43, 6.83, 7.17             |  | KIT 2643B   |  |                         |                         |                     |
| 130A  | Thrust screw (not shown)                           |   |  | 1                       | 15-X-1167               |                     |
| 130B  | Jam nut (not shown)                                |   |  | 1                       | 1227-D-472              |                     |
| 131   | Washer - diff. bearing cap                         |   |  | 4                       | 42-X-1024               |                     |
| 132   | Capscrew - diff. bearing cap                       |   |  | 4                       | 41-X-1018               |                     |
| 133   | Adjusting ring - diff. bearing                     | LH & RH   | 1511, 1560, 1658, 1660                             | 2                       | 2214-U-1269             |                     |
|   |  | LH  | 1708, 1712, 1823, 1825,                            |                         | 1                       | 2214-G-1125         |
|   |  | RH  | 1892, 1897, 1928, 2138                             | 2214-J-1128             |                         |                     |
|   |  | LH  | 3200-H-1854 (ABS)                                  | 2                       | KIT 2830                |                     |
|   |  | RH  |  |                         | 2214-Z-1144             |                     |
|   |  | LH & RH   | 3200-J-1856 (ABS)                                  | 2                       | 2214-Z-1144             |                     |
| 134   | Pin - adjusting ring                               |   | 3200-P-1706  | 2                       | 2214-G-1125             |                     |
|   |  |   | ABS carriers                                       |                         | 19-X-1087               |                     |
| 135   | Cup - differential bearing                         |   | All others   | 1                       | KIT 4284                |                     |
|   |  | LH & RH   | 1511, 1560, 1658, 1660                             | 2                       | A1-1228-B-600           |                     |
| 135A  | Adhesive - diff. bearing cup                       | LH  | 1708, 1712, 1823, 1825,                            | 1                       | 592A                    |                     |
|   |  | RH  | 1892, 1897, 1928, 1929, 2138                       |                         | 52618                   |                     |
|   |  | LH & RH   | 3200-P-1706  |                         | 2                       | 592A                |
| 136   | Cone - differential bearing                        | LH & RH   | 1511, 1560, 1658, 1660                             | 2                       | A1-1228-B-600           |                     |
|   |  | LH  | 1708, 1712, 1823, 1825,                            |                         | 1                       | 594A                |
|   |  | RH  | 1892, 1897, 1928, 1929, 2138                       | 52400                   |                         |                     |
|   |  | LH & RH   | 3200-P-1706  | 2                       | 594A                    |                     |
| 137   | Nut - diff. case to gear                           | Included in KIT 2426                              |  | 12                      | 40-X-1182               |                     |
| 138   | Washer - diff. case to gear                        |   |  | 12                      | 1229-U-1503             |                     |
| 139   | Bolt - diff. case to gear                          |   |  | 12                      | 41-X-1276 <sup>10</sup> |                     |

7 No longer available

10 For Coach Quality use 41-X-1555 (KIT 4745)

# CARRIERS FOR SINGLE AXLES AND REARS OF TANDEM AXLES

| ITEM  | DESCRIPTION  | REMARKS   | CARRIER  | QTY           | PART NUMBER                                  |
|---|--|---|--|---------------|--|
| 140 thru 147  | Case & nest assy. - main diff.<br>All shown are 2.38"-46 axle spline.    | Ratios - 3.07, 3.21, 3.42, 3.58, 3.73, 3.91, 4.10, 4.30, 4.56 | 3200-C-1511<br>Aluminum<br>Less diff. lock   | Use 1 as req. | A11-3235-S-1813 <sup>5</sup>                 |
|   |  | Ratios - 3.91, 4.10, 4.30, 4.56                               |  |               | A11-3235-F-1982 <sup>6</sup>                 |
|   |  | Ratios - 4.89, 5.38, 5.63, 6.14, 6.43, 6.83, 7.17             |  |               | A11-3235-H-1984 <sup>23</sup>                |
|   |  | Ratios - 3.07, 3.21, 3.42, 3.58, 3.73, 3.91, 4.10, 4.30, 4.56 | 3200-C-1511<br>Aluminum<br>With diff. lock   |               | A13-3235-S-1813 <sup>5</sup>                 |
|   |  | Ratios - 3.91, 4.10, 4.30, 4.56                               |  |               | A13-3235-F-1982 <sup>6</sup>                 |
|   |  | Ratios - 4.89, 5.38, 5.63, 6.14, 6.43, 6.83, 7.17             |  |               | A13-3235-H-1984 <sup>23</sup>                |
|   |  | Ratios - 2.50, 2.67, 2.80, 2.93                               | 3200-P-1706,<br>3200-A-1821,<br>3200-E-2137<br>Less diff. lock   |               | A1-3235-R-2202                               |
|   |  | Ratios - 3.07, 3.21, 3.42, 3.58, 3.73                         |  |               | A1-3235-C-2109 <sup>11</sup>                 |
|   |  | Ratios - 3.91, 4.10, 4.30, 4.56                               |  |               | A1-3235-E-2111 <sup>12</sup>                 |
|   |  | Ratios - 4.89, 5.38, 5.63, 6.14, 6.43, 6.83, 7.17             | 3200-R-1708, 3200-V-1712<br>Alum., 3200-C-1823,<br>3200-E-1825 Alum.,<br>3200-T-1892, 3200-Y-1897<br>Alum., 3200-D-1928,<br>3200-E-1929 Alum.,<br>3200-F-2138<br>With diff. lock |               | A1-3235-G-2113 <sup>13</sup>                 |
|   |  | Ratios - 2.50, 2.73, 2.80, 2.93                               |  |               | A3-3235-R-2202                               |
|   |  | Ratios - 3.07, 3.21, 3.42, 3.58, 3.73                         |  |               | A3-3235-C-2109 <sup>14</sup>                 |
|   |  | Ratios - 3.91, 4.10, 4.30, 4.56                               | 3200-T-1658<br>Less diff. lock   |               | A3-3235-E-2111 <sup>15</sup>                 |
|   |  | Ratios - 4.89, 5.38, 5.63, 6.14, 6.43, 6.83, 7.17             |  |               | A3-3235-G-2113 <sup>16</sup>                 |
|   |  | Ratios - 3.07, 3.21, 3.42, 3.58, 3.73                         |  |               | A11-3235-S-1813                              |
|   |  | Ratios - 3.91, 4.10, 4.30, 4.56                               | 3200-V-1600<br>With diff. lock   |               | A11-3235-F-1982                              |
|   |  | Ratios - 4.89, 5.38, 5.63, 6.14, 6.43, 6.83, 7.17             |  |               | A11-3235-H-1984 <sup>23</sup>                |
|   |  | Ratios - 3.07, 3.21, 3.42, 3.58, 3.73                         |  |               | A13-3235-S-1813                              |
|   |  | Ratios - 3.91, 4.10, 4.30, 4.56                               | 3200-V-1712, 3200-E-1825,<br>3200-Y-1897, 3200-E-1929,<br>Aluminum,<br>Less diff. lock   |               | A13-3235-F-1982                              |
|   |  | Ratios - 4.89, 5.38, 5.63, 6.14, 6.43, 6.83, 7.17             |  |               | A13-3235-H-1984 <sup>23</sup>                |
|   |  | Ratios - 3.07, 3.21, 3.42, 3.58, 3.73, 3.91, 4.10, 4.30, 4.56 |  |               | A6-3235-C-2109                               |
|   |  | Ratios - 3.91, 4.10, 4.30, 4.56                               | 3200-Z-1560<br>With or Without diff. lock  |               | A6-3235-E-2111                               |
|   |  | Ratios - 4.89, 5.38, 5.63, 6.14, 6.43, 6.83, 7.17             |  |               | A6-3235-G-2113                               |
|   |  | Ratios - 3.07, 3.21, 3.42, 3.58, 3.73, 3.91, 4.10, 4.30, 4.56 |  |               | A2-3235-S-1813 <sup>5</sup><br>plus KIT 2318 |
|   |  | Ratios - 3.91, 4.10, 4.30, 4.56                               | 3200-H-1854,<br>Internal ABS,<br>Less diff. lock,<br>Aluminum  |               | A3-3235-F-1982 <sup>6</sup>                  |
|   |  | Ratios - 4.89, 5.38, 5.63, 6.14, 6.43, 6.83, 7.17             |  |               | A3-3235-H-1984 <sup>23</sup>                 |
|   |  | Ratios - 3.07, 3.21, 3.42, 3.58, 3.73                         |  |               | A4-3235-R-2176 <sup>23</sup>                 |
|   |  | Ratios - 3.91, 4.10, 4.30, 4.56                               | 3200-J-1856,<br>Internal ABS,<br>Less diff. lock,<br>Malleable iron  |               | A4-3235-S-2177 <sup>23</sup>                 |
| Ratios - 4.89, 5.38, 5.63, 6.14, 6.43, 6.83, 7.17             | A4-3235-T-2178 <sup>23</sup>   |   |  |               |  |
| Ratios - 3.07, 3.21, 3.42, 3.58, 3.73                         | A2-3235-R-2176 <sup>23</sup>   |   |  |               |  |
| Ratios - 3.91, 4.10, 4.30, 4.56                               | 3200-C-1511<br>Aluminum<br>Less diff. lock                               | A2-3235-S-2177 <sup>23</sup>                                  |  |               |  |
| Ratios - 4.89, 5.38, 5.63, 6.14, 6.43, 6.83, 7.17             |  | A2-3235-T-2178 <sup>23</sup>                                  |  |               |  |
| Ratios - 3.07, 3.21, 3.42, 3.58, 3.73, 3.91, 4.10, 4.30, 4.56 |  | A14-3235-S-1813 <sup>5</sup>                                  |  |               |  |
| Ratios - 3.91, 4.10, 4.30, 4.56                               | 3200-P-1706<br>Less diff. lock   | A14-3235-F-1982 <sup>6</sup>                                  |  |               |  |
| Ratios - 4.89, 5.38, 5.63, 6.14, 6.43, 6.83, 7.17             |  | A14-3235-H-1984 <sup>23</sup>                                 |  |               |  |
| Ratios - 3.07, 3.21, 3.42, 3.58, 3.73                         |  | A7-3235-C-2109  |  |               |  |
| Ratios - 3.91, 4.10, 4.30, 4.56                               | 3200-T-1658<br>Less diff. lock   | A7-3235-E-2111  |  |               |  |
| Ratios - 4.89, 5.38, 5.63, 6.14, 6.43, 6.83, 7.17             |  | A7-3235-G-2113  |  |               |  |
| Ratios - 3.07, 3.21, 3.42, 3.58, 3.73                         |  | A14-3235-S-1813   |  |               |  |
| Ratios - 3.91, 4.10, 4.30, 4.56                               | 3200-V-1712, 3200-E-1825,<br>3200-Y-1897,<br>Aluminum<br>Less diff. lock | A14-3235-F-1982   |  |               |  |
| Ratios - 4.89, 5.38, 5.63, 6.14, 6.43, 6.83, 7.17             |  | A14-3235-H-1984 <sup>23</sup>                                 |  |               |  |
| Ratios - 3.07, 3.21, 3.42, 3.58, 3.73                         |  | A8-3235-C-2109  |  |               |  |
| Ratios - 3.91, 4.10, 4.30, 4.56                               | 3200-V-1712, 3200-E-1825,<br>3200-Y-1897,<br>Aluminum<br>Less diff. lock | A8-3235-E-2111  |  |               |  |
| Ratios - 4.89, 5.38, 5.63, 6.14, 6.43, 6.83, 7.17             |  | A8-3235-G-2113  |  |               |  |

5 For use with carriers built prior to Sept. 1, 1988.

(Applies to ratios 3.91 thru 4.56 only.)

11 For Coach Quality use A1-3235-Y-2469

12 For Coach Quality use A1-3235-P-2460

13 For Coach Quality use A1-3235-M-2457

23 No Longer Available – Contact Florence Specifications for assistance

6 For use with carriers produced after Sept. 1, 1988 or have been

retro-fitted with KIT 2468 or KIT 2655 only.

14 For Coach Quality use A3-3235-Y-2469

15 For Coach Quality use A3-3235-P-2460

16 For Coach Quality use A3-3235-M-2457

# CARRIERS FOR SINGLE AXLES AND REARS OF TANDEM AXLES

| ITEM                         | DESCRIPTION                               | REMARKS   | CARRIER  | QTY           | PART NUMBER                   |
|------------------------------|---|---|--|---------------|-------------------------------|
| 140, 146 & 147               | Case assy - main differential             | Ratios - 3.07, 3.21, 3.42, 3.58, 3.73, 3.91, 4.10, 4.30, 4.56 | 3200-C-1511<br>Aluminum<br>Less diff. lock   | Use 1 as req. | A10-3235-S-1813 <sup>5</sup>  |
|                              |   | Ratios - 3.91, 4.10, 4.30, 4.56                               |  |               | A10-3235-F-1982 <sup>6</sup>  |
|                              |   | Ratios - 4.89, 5.38, 5.63, 6.14, 6.43, 6.83, 7.17             |  |               | A10-3235-H-1984 <sup>23</sup> |
|                              |   | Ratios - 3.07, 3.21, 3.42, 3.58, 3.73, 3.91, 4.10, 4.30, 4.56 | 3200-C-1511<br>Aluminum<br>With diff. lock   |               | A12-3235-S-1813 <sup>5</sup>  |
|                              |   | Ratios - 3.91, 4.10, 4.30, 4.56                               |  |               | A12-3235-F-1982 <sup>6</sup>  |
|                              |   | Ratios - 4.89, 5.38, 5.63, 6.14, 6.43, 6.83, 7.17             |  |               | A12-3235-H-1984 <sup>23</sup> |
|                              |   | Ratios - 2.50, 2.67, 2.80, 2.93                               | 3200-P-1706, 3200-A-1821,<br>3200-E-2137<br>Less diff. lock  |               | A-3235-R-2202                 |
|                              |   | Ratios - 3.07, 3.21, 3.42, 3.58, 3.73                         |  |               | A-3235-C-2109 <sup>17</sup>   |
|                              |   | Ratios - 3.91, 4.10, 4.30, 4.56                               |  |               | A-3235-E-2111 <sup>18</sup>   |
|                              |   | Ratios - 4.89, 5.38, 5.63, 6.14, 6.43, 6.83, 7.17             | 3200-R-1708, 3200-V-1712<br>Alum., 3200-C-1823,<br>3200-E-1825 Alum.,<br>3200-T-1892, 3200-Y-1897<br>Alum., 3200-D-1928,<br>3200-E-1929 Alum.,<br>3200-T-2138<br>With diff. lock |               | A-3235-G-2113 <sup>19</sup>   |
|                              |   | Ratios - 2.50, 2.67, 2.80, 2.93                               |  |               | A2-3235-R-2202                |
|                              |   | Ratios - 3.07, 3.21, 3.42, 3.58, 3.73                         |  |               | A2-3235-C-2109 <sup>20</sup>  |
|                              |   | Ratios - 3.91, 4.10, 4.30, 4.56                               | 3200-T-1658<br>Less diff. lock   |               | A2-3235-E-2111 <sup>21</sup>  |
|                              |   | Ratios - 4.89, 5.38, 5.63, 6.14, 6.43, 6.83, 7.17             |  |               | A2-3235-G-2113 <sup>22</sup>  |
|                              |   | Ratios - 3.07, 3.21, 3.42, 3.58, 3.73                         |  |               | A10-3235-S-1813               |
|                              |   | Ratios - 3.91, 4.10, 4.30, 4.56                               | 3200-V-1660<br>With diff. lock   |               | A10-3235-F-1982               |
|                              |   | Ratios - 4.89, 5.38, 5.63, 6.14, 6.43, 6.83, 7.17             |  |               | A10-3235-H-1984 <sup>23</sup> |
|                              |   | Ratios - 3.07, 3.21, 3.42, 3.58, 3.73                         |  |               | A12-3235-S-1813               |
|                              |   | Ratios - 3.91, 4.10, 4.30, 4.56                               | 3200-V-1712, 3200-E-1825,<br>3200-Y-1897, 3200-E-1929,<br>Aluminum,<br>Less diff. lock   |               | A12-3235-F-1982               |
|                              |   | Ratios - 4.89, 5.38, 5.63, 6.14, 6.43, 6.83, 7.17             |  |               | A12-3235-H-1984 <sup>23</sup> |
|                              |   | Ratios - 3.07, 3.21, 3.42, 3.58, 3.73, 3.91, 4.10, 4.30, 4.56 |  |               | A5-3235-C-2109                |
|                              |   | Ratios - 4.89, 5.38, 5.63, 6.14, 6.43, 6.83, 7.17             | 3200-Z-1560<br>Less diff. lock   |               | A5-3235-E-2111                |
|                              |   | Ratios - 3.07, 3.21, 3.42, 3.58, 3.73, 3.91, 4.10, 4.30, 4.56 |  |               | A5-3235-G-2113                |
|                              |   | Ratios - 4.89, 5.38, 5.63, 6.14, 6.43, 6.83, 7.17             |  |               | A-3235-S-1813 <sup>5</sup>    |
|                              |   | Ratios - 3.07, 3.21, 3.42, 3.58, 3.73, 3.91, 4.10, 4.30, 4.56 | 3200-Z-1560<br>With diff. lock   |               | A2-3235-F-1982 <sup>6</sup>   |
|                              |   | Ratios - 4.89, 5.38, 5.63, 6.14, 6.43, 6.83, 7.17             |  |               | A-3235-H-1984 <sup>23</sup>   |
|                              |   | Ratios - 3.07, 3.21, 3.42, 3.58, 3.73, 3.91, 4.10, 4.30, 4.56 |  |               | A2-3235-S-1813 <sup>5</sup>   |
|                              |   | Ratios - 4.89, 5.38, 5.63, 6.14, 6.43, 6.83, 7.17             | 3200-H-1854,<br>Internal ABS,<br>Less diff. lock,<br>Aluminum  |               | A2-3235-F-1982 <sup>6</sup>   |
|                              |   | Ratios - 3.07, 3.21, 3.42, 3.58, 3.73, 3.91, 4.10, 4.30, 4.56 |  |               | A2-3235-H-1984 <sup>23</sup>  |
|                              |   | Ratios - 4.89, 5.38, 5.63, 6.14, 6.43, 6.83, 7.17             |  |               | A5-3235-R-2176 <sup>23</sup>  |
| 140, 146, 147, 173, 174, 175 | Case assy - main differential (ABS ready) | Ratios - 3.07, 3.21, 3.42, 3.58, 3.73                         | 3200-J-1856,<br>Internal ABS,<br>Less diff. lock,<br>Malleable iron  | Use 1 as req. | A5-3235-S-2177 <sup>23</sup>  |
|                              |   | Ratios - 3.91, 4.10, 4.30, 4.56                               |  |               | A3-3235-T-2178 <sup>23</sup>  |
|                              |   | Ratios - 4.89, 5.38, 5.63, 6.14, 6.43, 6.83, 7.17             |  |               | A1-3235-R-2176 <sup>23</sup>  |
|                              |   | Ratios - 3.07, 3.21, 3.42, 3.58, 3.73                         |  |               | A1-3235-S-2177 <sup>23</sup>  |
|                              |   | Ratios - 3.91, 4.10, 4.30, 4.56                               |  |               | A1-3235-T-2178 <sup>23</sup>  |
| 141                          | Thrust washer - side gear                 | Included in KIT 2318  | 46 Spline  | 2             | 1229-L-3002                   |
|                              |   |   |  |               | 2234-C-1069                   |
|                              |   |   |  |               | 2234-C-1069N                  |
| 142                          | Side gear - differential                  | Coach Quality . Included in KIT 2575                          | 50 Spline  | 2             | 2234-D-1070                   |
|                              |   |   |  |               | A-3230-C-1043                 |
| 142A                         | No-Spin assembly                          |   | 46 Spline  | 1             | A-3230-C-1043                 |
| 143                          | Thrust washer - diff. pinion              | Included in KIT 2318  |  | 4             | 1229-K-3001                   |
| 144                          | Gear - diff. pinion                       |   |  |               | 2233-M-1001                   |
| 145                          | Spider diff.                              |   |  |               | 3278-W-335                    |
| 146                          | Washer - diff. case                       |   |  |               | 1229-U-1503                   |
| 147                          | Capscrew - diff. case                     |   |  | 12            | 41-X-1275                     |
| 147A                         | Thread locking liquid                     |   |  | 1             | 2297-C-7049                   |

5 For use with carriers built prior to Sept. 1, 1988.

(Applies to ratios 3.91 thru 4.56 only.)

17 For Coach Quality use A-3235-Y-2469

18 For Coach Quality use A-3235-P-2460

19 For Coach Quality use A-3235-M-2457

23 No Longer Available – Contact Florence Specifications for assistance

6 For use with carriers produced after Sept. 1, 1988 or have been retro-fitted with KIT 2468 or KIT 2655 only.

20 For Coach Quality use A2-3235-Y-2469

21 For Coach Quality use A2-3235-P-2460

22 For Coach Quality use A2-3235-M-2457

# CARRIERS FOR SINGLE AXLES AND REARS OF TANDEM AXLES

| ITEM  | DESCRIPTION                           | REMARKS          | CARRIER  | QTY | PART NUMBER              |
|---|---------------------------------------|------------------|--|-----|--------------------------|
| <b>THE FOLLOWING PARTS ARE FOR MAIN DIFFERENTIAL LOCK</b> |                                       |                  |  |     |                          |
| 148   | DCDL Switch Kit                       |                  |  | 1   | KIT 4429                 |
| Not Shown   | Plug - sensor port                    |                  |  | 1   | 41-X-1022                |
| 149   | Lock nut - sensor/switch              | Prior to 11/93   | Used on carriers with 3266-F-1020 air cyl. cover             | 1   | 1227-P-1056              |
| 150   | Shift fork - main diff. lock          | Three pc. design | 3200-Z-1560  | 1   | 3296-B-184               |
|   |                                       | One pc. design   | After 11/93  |     | 3296-B-1172              |
| 151   | Spring - main diff. lock              |                  | Prior to 11/93   | 1   | 3296-Y-1169 <sup>1</sup> |
|   |                                       |                  | After 11/93  |     | 2258-N-1262              |
| 152   | Shift shaft - main diff. lock         |                  | 1511, 1560, 1660   | 1   | 2244-Y-51                |
|   |                                       |                  | 1708, 1712, 1823   |     | 2244-L-1026              |
|   |                                       |                  | 1892, 1897, 1928, 1929, 2138                                 |     | KIT 2824                 |
| 152A  | Washer - piston (not shown)           |                  | Prior to 11/93   | 1   | 42-X-1027                |
| 153   | Shift cylinder housing                | Screw-in style   | After 11/93  | 1   | KIT 2824                 |
|   | Tube - air cylinder                   | Bolt-on style    | Prior to 11/93   |     | 3196-F-32                |
| 153A  | Plug - cylinder hole                  |                  |  | 1   | 1250-U-1217              |
| 154   | Piston - main diff. lock              |                  | After 11/93  | 1   | KIT 2824                 |
|   |                                       |                  | Prior to 11/93   |     | 2230-N-170               |
| 155   | Gasket - air cylinder cover           |                  | Prior to 11/93   | 1   | 2208-H-944               |
| 156   | Capscrew - manual engaging            |                  | After 11/93  | 1   | 41-X-1368                |
|   |                                       |                  | Prior to 11/93   |     | 41-X-1333                |
| 156A  | O-ring                                |                  |  | 1   | 5-X-521                  |
| 157   | Cover - air cylinder                  | Bolt-on style    | Prior to 11/93   | 1   | 3266-F-1020              |
| 158   | Washer - adjusting ring lock capscrew |                  |  | 2   | MWA-508                  |
| 159   | Capscrew - adjusting ring lock        |                  |  | 2   | MS-208020-1              |
| 160   | Lock - adjusting ring                 |                  |  | 1   | 1220-K-89                |
| 161   | Pin - shift fork                      | Three pc. design |  | 2   | 43-X-1007                |
| 162   | Clutch collar - main diff. lock       |                  | 1511, 1660, 1628   | 1   | 3107-F-1020              |
|   |                                       | 46 Spline        | 1708, 1712, 1823, 1825, 1892<br>1894, 1897, 1928, 1929, 2138 |     | 3107-B-1094              |
|   |                                       | 50 Spline        | 1708, 1823   |     | 3107-C-1095              |
|   |                                       |                  | 3200-Z-1560  |     | 3107-P-1030              |
| 163   | Roll pin - spring retaining           |                  | Prior to 11/93   | 1   | 43-X-1006                |
| 164   | O-ring - piston                       |                  | After 11/93  | 1   | 5-X-1198                 |
|   |                                       |                  | Prior to 11/93   |     | 5-X-1153                 |
| 165   | Washer - air cylinder cover           |                  | Prior to 11/93   | 4   | MWA-506                  |
| 166   | Capscrew - air cylinder cover         |                  | Prior to 11/93   | 4   | 41-X-1364                |
| 167   | Gasket - plug                         |                  | Prior to 11/93   | 1   | 2208-L-1000              |
| 168   | Plug - air cylinder cover             |                  | Prior to 11/93   | 1   | MS-210016-1              |

**THE FOLLOWING PARTS ARE FOR CARRIERS WITH INTERNAL A.B.S. SENSORS**

|      |                                     |               |                       |   |                          |
|------|-------------------------------------|---------------|-----------------------|---|--------------------------|
| 169  | Wave washer - adjusting ring        |               |                       | 2 | 2258-G-1255              |
| 170  | Snap ring - adjusting ring          |               |                       | 2 | 1229-F-4452              |
| 171  | Snap ring - sensor                  |               |                       | 2 | 1229-U-4519              |
| 172A | Plug - sensor attaching (not shown) | Aluminum only | 3200-H-1854 (LH side) | 1 | 1250-T-1216 <sup>7</sup> |
| 173  | Drive tube                          |               |                       | 2 | 3216-G-4375 <sup>7</sup> |
| 174  | Washer - drive tube                 |               |                       | 2 | 42-X-1408                |
| 175  | Snap ring - drive tube              |               |                       | 2 | 1229-D-4528              |
| 172  | Sensor - ABS                        | LH side       | 3200-H-1854           | 1 | SA2-3280-X-9150          |
|      |                                     | RH side       |                       |   | SA1-3280-X-9150          |
|      |                                     | Both sides    | 3200-J-1856           | 2 | SA1-3280-X-9150          |

<sup>1</sup> Prior to 11/92 all carriers (except 3200-Z-1560) used the three piece design fork (3296-R-1084) which was replaced by 3296-Y-1169 in 11/92.      <sup>7</sup> No Longer Available

# OUTPUT (THRU) SHAFT ASSEMBLY PARTS



| ITEM | DESCRIPTION                                      | REMARKS                               | QTY           | PART NUMBER      |
|------|--|---------------------------------------|---------------|------------------|
| 200  | Output (thru) shaft, bearing cage and seal assy. | Includes Items 201, 202, 205 thru 211 | 1             | A2-3226-T-1112S  |
| 201  | Shaft - output (thru)                            |                                       | 1             | 3297-V-1010      |
| 202  | Bearing cage & inner cup assy. - output          |                                       | 1             | A-3226-T-1112    |
| 202A | Deflector (no longer used)                       |                                       | 1             | N/A <sup>8</sup> |
| 203  | Washer - output bearing cage capscrew            |                                       | 4             | 1229-K-1597      |
| 204  | Capscrew - output bearing cage                   |                                       | 4             | 15-X-387         |
| 205  | Cups - inner & outer output bearing              |                                       | 2             | JLM-104910       |
| 206  | Cones - inner & outer output bearing             |                                       | 2             | LM-104949        |
| 207  | Snap ring (spacer) - output bearing              | Included in KIT 576                   | Use 1 as req. | .155 inch        |
|      |  |                                       |               | .158 inch        |
|      |  |                                       |               | .161 inch        |
|      |  |                                       |               | .164 inch        |
|      |  |                                       |               | .167 inch        |
|      |  |                                       |               | .170 inch        |
|      |  |                                       |               | .173 inch        |
|      |  |                                       |               | .176 inch        |
|      |  |                                       |               | .179 inch        |
|      |  | .182 inch                             |               |                  |
| 208  | Snap ring spacer - output bearing/yoke           |                                       | 1             | 1229-W-4131      |
| 209  | Oil seal - output bearing cage                   | 2 piece (seal & sleeve)               | 1             | A1-1205-Y-2729   |
| 210  | Washer - yoke nut (output)                       | Included in KIT 2637                  | 1             | 1229-T-1736      |
| 211  | Nut - output yoke                                |                                       | 1             | 40-X-1237        |

<sup>8</sup> Use A1-1205-Y-2729 seal & sleeve. Do not use deflector.

# HOUSING ASSEMBLY PARTS



| ITEM | DESCRIPTION                              | REMARKS  | COMMENTS                                 | QTY | PART NUMBER   |
|------|--|--|--|-----|---------------|
| 212  | Axle housing assembly                    |  |  | 1   | AS SPECIFIED  |
| 213  | Breather assembly - housing              |  |  | 1   | KIT 2902      |
| 214  | Stud - carrier to housing                | Forward-rear only  | Long                                     | 1   | 4-X-1922      |
|      |  |  | Short                                    | 1   | 4-X-1921      |
|      |  |  |  | 2   | 4-X-1921      |
| 215  | Plug - heat indicator                    |  | Use as required                          | 1   | P-28S         |
| 216  | Plug - filler hole                       |  |  | 1   | P-212         |
| 217  | Washer - carrier to housing nut          | Forward-rear only  | For 12 mtg. hole version                 | 2   | 1229-W-1557   |
|      |  |  | For 15 mtg. hole version                 | 3   | 1229-W-1557   |
| 218  | Nut - carrier to housing stud            | Forward-rear only  | For 12 mtg. hole version                 | 2   | N-110-1       |
|      |  |  | For 15 mtg. hole version                 | 3   | N-110-1       |
|      |  |  | For 12 mtg. hole version                 | 7   | 10-X-1594     |
|      |  |  | For 15 mtg. hole version                 | 9   | 10-X-1594     |
| 219  | Capscrew - carrier to housing            | Forward-rear axles, RP & RD 23-160/164, 26-160/164       | For tapered dowel versions <sup>23</sup> | 5   | 10-X-1594     |
|      |  |  | For tapered dowel versions <sup>23</sup> | 4   | 10-X-1595     |
|      |  |  | All forwards                             | 3   | 10-X-1599     |
|      |  |  |  | 8   | 10-X-1594     |
|      |  | Rear-rear & single axles, RS & RR 23-160/164, 26-160/164 | For tapered dowel versions <sup>23</sup> | 5   | 10-X-1594     |
|      |  |  | For tapered dowel versions <sup>23</sup> | 3   | 10-X-1595     |
|      |  |  |  | 4   | 10-X-1600     |
|      |  |  | For tapered dowel versions <sup>23</sup> | 3   | 10-X-1600     |
|      |  | 1  | 10-X-1767                                |     |               |
| 220  | Washer - carrier to housing capscrew     | Forward-rear only  | For 12 mtg. hole version                 | 10  | 1229-W-1557   |
|      |  |  | For 15 mtg. hole version                 | 12  | 1229-W-1557   |
|      |  | Rear-rear & singles                                      |  | 12  | 1229-W-1557   |
| 221  | Plug - drain (magnetic)                  |  |  | 1   | 1250-E-473    |
| 222  | Oil seal assembly                        | Unitized   |  | 2   | A-1205-Q-2487 |
|      |  | Use with wiper below                                     |  | 2   | A-1205-T-696  |
| 222A | Wiper - housing spindle inner (optional) | Not shown  | Chrome plated                            | 2   | 1199E1669     |
| 223  | Cone - bearing inner wheel               |  |  | 2   | 594A          |
| 224  | Cup - bearing inner wheel                |  |  | 2   | 592A          |
| 225  | Cup - bearing outer wheel                |  |  | 2   | 572           |
| 226  | Cone - bearing outer wheel               |  |  | 2   | 580           |
| 227  | Nut - bearing adjusting inner            |  |  | 2   | 1227-W-517    |
| 228  | Washer - adjusting nut                   | Off-highway  |  | 2   | 1229-U-1009   |
| 229  | Tanged washer & adjusting nut washer     | On-highway   |  | 2   | 1229-F-4634S  |
| 230  | Nut - outer jam                          |  |  | 2   | 1227-R-330    |

<sup>23</sup> Dowel part number is 1246-V-1166. Quantity 6 for forward (KIT 4288) and quantity 4 for rear (KIT 4291).



# AXLE SHAFT SETS FOR 160, 161 and 164 SERIES AXLES

| LEFT<br>HAND | RIGHT<br>HAND |
|--------------|---------------|
|--------------|---------------|

**RS-20-160**      Single Axle

|             |              |
|-------------|--------------|
| 3202-Q-8805 | 3202-B-8816* |
| 3202-Q-8805 | 3202-G-9003  |

**RS-21-160**      Single Axle

|             |              |
|-------------|--------------|
| 3202-Q-8805 | 3202-B-8816* |
| 3202-Q-8805 | 3202-G-9003  |
| 3202-H-9004 | 3202-R-8806  |
| 3202-H-9004 | 3202-C-8817* |
| 3202-Y-9125 | 3202-Z-9126  |
| 3202-Y-9125 | 3202-C-9129* |
| 3202-J-9344 | 3202-K-9345  |
| 3202-J-9344 | 3202-L-9346* |

**RS-22-160**      Single Axle

|             |              |
|-------------|--------------|
| 3202-Q-8805 | 3202-B-8816* |
| 3206-X-1532 | 3206-Z-1534  |

**RC-23-160**      Single Axle

|             |             |
|-------------|-------------|
| 3202-Q-8805 | 3202-G-9003 |
| 3202-Y-8683 | 3202-P-8804 |

**RS-23-160**      Single Axle

|              |               |
|--------------|---------------|
| 3202-X-8110  | 3206-T-1190   |
| 3202-Q-8805  | 3202-B-8816 * |
| 3202-Q-8805  | 3202-G-9003   |
| 3202-H-9004  | 3202-R-8806   |
| 3202-H-9004  | 3202-C-8817 * |
| 3202-Y-9125  | 3202-Z-9126   |
| 3202-Y-9125  | 3202-C-9129*  |
| 3202-A-9127  | 3202-B-9128   |
| 3202-D-9130* | 3202-A-9127   |
| 3202-J-9344  | 3202-L-9346 * |
| 3202-J-9344  | 3202-K-9345   |
| 3202-Y-9489  | 3202-Z-9490   |
| 3202-Y-9489  | 3202-A-9491 * |
| 3202-L-9502  | 3202-L-9918   |
| 3202-K-9553  | 3202-A-9647*  |
| 3202-E-9573  | 3202-F-9574   |
| 3202-E-9573  | 3202-G-9575 * |

**RS-23-161**      Single Axle

|             |               |
|-------------|---------------|
| 3202-Q-8805 | 3202-B-8816 * |
| 3202-Q-8805 | 3202-G-9003   |
| 3202-J-9344 | 3202-K-9345   |
| 3202-J-9344 | 3202-L-9346 * |
| 3202-Y-9489 | 3202-Z-9490   |
| 3202-Y-9489 | 3202-A-9491 * |
| 3202-L-9918 | 3202-L-9502   |

| LEFT<br>HAND | RIGHT<br>HAND |
|--------------|---------------|
|--------------|---------------|

**RS-24-160**      Single Axle

|             |             |
|-------------|-------------|
| 3202-Y-8683 | 3202-P-8804 |
| 3202-Y-8683 | 3202-A-8815 |

**RS-25-160**      Single Axle

|             |              |
|-------------|--------------|
| 3202-Q-8805 | 3202-B-8816* |
| 3202-Q-8805 | 3202-G-9003  |
| 3202-Y-9125 | 3202-Z-9126  |
| 3202-Y-9125 | 3202-C-9129* |
| 3202-J-9344 | 3202-K-9345  |
| 3202-J-9344 | 3202-L-9346* |

**RS-26-160**      Single Axle

|             |               |
|-------------|---------------|
| 3202-G-9393 | 3202-B-8816 * |
| 3202-G-9393 | 3202-G-9003   |

**RD-20-160**      Fwd. axle less pump  
RT-40-160 Tandem

|              |             |
|--------------|-------------|
| 3202-R-8806  | 3202-H-9004 |
| 3202-B-8816* | 3202-Q-8805 |
| 3202-G-9003  | 3202-Q-8805 |
| 3202-Z-9126  | 3202-Y-9125 |
| 3202-C-9129* | 3202-Y-9125 |
| 3202-K-9345  | 3202-J-9344 |
| 3202-L-9346* | 3202-J-9344 |

**RD-23-160**      Fwd. axle less pump  
RT-46-160 Tandem

|               |              |
|---------------|--------------|
| 3202-R-8806   | 3202-H-9004  |
| 3202-B-8816 * | 3202-Q-8805  |
| 3202-C-8817 * | 3202-H-9004  |
| 3202-G-9003   | 3202-Q-8805  |
| 3202-Z-9126   | 3202-Y-9125  |
| 3202-A-9127   | 3202-D-9130* |
| 3202-C-9129*  | 3202-Y-9125  |
| 3202-K-9345   | 3202-J-9344  |
| 3202-L-9346 * | 3202-J-9344  |
| 3202-Z-9490   | 3202-Y-9489  |
| 3202-A-9491 * | 3202-Y-9489  |
| 3202-F-9574   | 3202-E-9573  |
| 3202-G-9575 * | 3202-E-9573  |
| 3202-J-9916   | 3202-L-9502  |

**RD-25-160**      Fwd. axle less pump  
RT-50-160 Tandem

|              |             |
|--------------|-------------|
| 3202-B-8816* | 3202-Q-8805 |
| 3202-G-9003  | 3202-Q-8805 |
| 3202-Z-9126  | 3202-Y-9125 |
| 3202-C-9129* | 3202-Y-9125 |
| 3202-K-9345  | 3202-J-9344 |
| 3202-L-9346* | 3202-J-9344 |

\* This shaft has longer splines that engage the differential lock.

# AXLE SHAFT SETS FOR 160, 161 and 164 SERIES AXLES

| LEFT<br>HAND | RIGHT<br>HAND |
|--------------|---------------|
|--------------|---------------|

**RP-20-160** Fwd. axle with pump  
RT-40-160 Tandem

|              |             |
|--------------|-------------|
| 3202-B-8816* | 3202-Q-8805 |
| 3202-C-8817* | 3202-H-9004 |
| 3202-G-9003  | 3202-Q-8805 |
| 3202-Z-9126  | 3202-Y-9125 |
| 3202-C-9129* | 3202-Y-9125 |
| 3202-K-9345  | 3202-J-9344 |
| 3202-L-9346* | 3202-J-9344 |

**RP-23-160** Fwd. axle with pump  
RT-46-160 Tandem

|               |              |
|---------------|--------------|
| 3202-R-8806   | 3202-H-9004  |
| 3202-B-8816 * | 3202-Q-8805  |
| 3202-C-8817 * | 3202-H-9004  |
| 3202-G-9003   | 3202-Q-8805  |
| 3202-Z-9126   | 3202-Y-9125  |
| 3202-A-9127   | 3202-D-9130* |
| 3202-B-9128   | 3202-A-9127  |
| 3202-C-9129*  | 3202-Y-9125  |
| 3202-K-9345   | 3202-J-9344  |
| 3202-L-9346 * | 3202-J-9344  |
| 3202-Z-9490   | 3202-Y-9489  |
| 3202-A-9491 * | 3202-Y-9489  |
| 3202-L-9502   | 3202-L-9918  |
| 3202-F-9574   | 3202-E-9573  |
| 3202-G-9575 * | 3202-E-9573  |
| 3202-A-9647*  | 3202-K-9553  |
| 3206-T-1190   | 3202-X-8110  |

**RP-23-164** Fwd. axle with pump  
RT-46-164 Tandem

|              |              |
|--------------|--------------|
| 3202-Q-8805  | 3202-B-8816* |
| 3202-C-8817* | 3202-H-9004  |

**RP-25-160** Fwd. axle with pump  
RT-50-160 Tandem

|              |             |
|--------------|-------------|
| 3202-R-8806  | 3202-H-9004 |
| 3202-B-8816* | 3202-Q-8805 |
| 3202-C-8817* | 3202-H-9004 |
| 3202-G-9003  | 3202-Q-8805 |
| 3202-Z-9126  | 3202-Y-9125 |
| 3202-C-9129* | 3202-Y-9125 |
| 3202-K-9345  | 3202-J-9344 |
| 3202-L-9346* | 3202-J-9344 |

**RR-20-160** Rear axle of  
RT-40-160 Tandem

|             |              |
|-------------|--------------|
| 3202-Q-8805 | 3202-B-8816* |
| 3202-Q-8805 | 3202-G-9003  |
| 3202-H-9004 | 3202-R-8806  |
| 3202-H-9004 | 3202-C-8817* |
| 3202-Y-9125 | 3202-Z-9126  |
| 3202-Y-9125 | 3202-C-9129* |
| 3202-J-9344 | 3202-K-9345  |
| 3202-J-9344 | 3202-L-9346* |

| LEFT<br>HAND | RIGHT<br>HAND |
|--------------|---------------|
|--------------|---------------|

**RR-23-160** Rear axle of  
RT-46-160 Tandem

|              |               |
|--------------|---------------|
| 3202-Q-8805  | 3202-B-8816 * |
| 3202-Q-8805  | 3202-G-9003   |
| 3202-X-8110  | 3206-T-1190   |
| 3202-H-9004  | 3202-R-8806   |
| 3202-H-9004  | 3202-C-8817 * |
| 3202-Y-9125  | 3202-Z-9126   |
| 3202-Y-9125  | 3202-C-9129*  |
| 3202-A-9127  | 3202-B-9128   |
| 3202-D-9130* | 3202-A-9127   |
| 3202-J-9344  | 3202-K-9345   |
| 3202-J-9344  | 3202-L-9346 * |
| 3202-Y-9489  | 3202-Z-9490   |
| 3202-Y-9489  | 3202-A-9491 * |
| 3202-L-9502  | 3202-J-9916   |
| 3202-K-9553  | 3202-A-9647*  |
| 3202-E-9573  | 3202-F-9574   |
| 3202-E-9573  | 3202-G-9575 * |
| 3202-L-9918  | 3202-L-9502   |

**RR-23-164** Rear axle of  
RT-56-164 Tandem

|             |              |
|-------------|--------------|
| 3202-Q-8805 | 3202-B-8816* |
|-------------|--------------|

**RR-25-160** Rear axle of  
RT-50-160 Tandem

|             |              |
|-------------|--------------|
| 3202-Q-8805 | 3202-B-8816* |
| 3202-H-9004 | 3202-R-8806  |
| 3202-H-9004 | 3202-C-8817* |
| 3202-Y-9125 | 3202-Z-9126  |
| 3202-Y-9125 | 3202-C-9129* |
| 3202-J-9344 | 3202-K-9345  |
| 3202-J-9344 | 3202-L-9346* |
| 3202-Q-8805 | 3202-G-9003  |

**RD-26-160** Fwd. axle less pump  
RT-52-160 Tandem

|               |             |
|---------------|-------------|
| 3202-B-8816 * | 3202-G-9393 |
| 3202-G-9003   | 3202-G-9393 |
| 3202-Q-9403*  | 3202-H-9004 |

**RP-26-160** Fwd. axle with pump  
RT-52-160 Tandem

|               |             |
|---------------|-------------|
| 3202-B-8816 * | 3202-G-9393 |
| 3202-G-9003   | 3202-Q-8805 |
| 3202-G-9003   | 3202-G-9393 |
| 3202-Q-9403*  | 3202-H-9004 |

**RR-26-160** Rear axle of  
RT-52-160 Tandem

|             |               |
|-------------|---------------|
| 3202-H-9004 | 3202-Q-9403*  |
| 3202-G-9393 | 3202-B-8816 * |
| 3202-G-9393 | 3202-G-9003   |

\* This shaft has longer splines that engage the differential lock.

# AXLE SHAFTS



| Part Number | Body Dia. | Length | Spline Size | Spline Len. | Flange Dia. | No. of Holes | Hole Size | Bolt Circle | Hole Type |
|-------------|-----------|--------|-------------|-------------|-------------|--------------|-----------|-------------|-----------|
| 3206-X-1532 | 2.00"     | 37.44" | 2.35"-46    | 3.03"       | 8.38"       | 8            | .73"      | 7.00"       | Taper     |
| 3206-Z-1534 | 2.00"     | 43.80" | 2.35"-46    | 3.03"       | 8.38"       | 8            | .73"      | 7.00"       | Taper     |
| 3202-J-9344 | 2.25"     | 36.57" | 2.35"-46    | 3.03"       | 8.38"       | 8            | .73"      | 7.00"       | Taper     |
| 3202-Y-9125 | 2.25"     | 36.57" | 2.35"-46    | 3.03"       | 8.38"       | 8            | .78"      | 7.00"       | Straight  |
| 3202-G-9393 | 2.25"     | 37.31" | 2.35"-46    | 3.03"       | 8.38"       | 8            | .73"      | 7.00"       | Taper     |
| 3202-Y-9489 | 2.25"     | 37.44" | 2.35"-46    | 3.03"       | 8.38"       | 8            | .64"      | 7.00"       | Straight  |
| 3202-Q-8805 | 2.25"     | 37.44" | 2.35"-46    | 3.03"       | 8.38"       | 8            | .73"      | 7.00"       | Taper     |
| 3202-K-9553 | 2.25"     | 39.44" | 2.35"-46    | 3.03"       | 8.38"       | 8            | .73"      | 7.00"       | Taper     |
| 3202-A-9127 | 2.25"     | 39.44" | 2.35"-46    | 3.03"       | 8.38"       | 8            | .78"      | 7.00"       | Straight  |
| 3202-Y-8683 | 2.25"     | 39.59" | 2.35"-46    | 3.03"       | 8.38"       | 8            | .73"      | 7.00"       | Taper     |
| 3202-E-9573 | 2.25"     | 40.31" | 2.35"-46    | 3.03"       | 8.38"       | 8            | .64"      | 7.00"       | Straight  |
| 3202-H-9004 | 2.25"     | 40.31" | 2.35"-46    | 3.03"       | 8.38"       | 8            | .73"      | 7.00"       | Taper     |
| 3202-P-8804 | 2.25"     | 41.57" | 2.35"-46    | 3.03"       | 8.38"       | 8            | .78"      | 7.00"       | Taper     |
| 3202-A-8815 | 2.25"     | 41.73" | 2.35"-46    | 9.14"       | 8.38"       | 8            | .78"      | 7.00"       | Straight  |
| 3202-K-9345 | 2.25"     | 42.91" | 2.35"-46    | 3.03"       | 8.38"       | 8            | .73"      | 7.00"       | Taper     |
| 3202-Z-9126 | 2.25"     | 42.91" | 2.35"-46    | 3.03"       | 8.38"       | 8            | .78"      | 7.00"       | Straight  |
| 3202-L-9346 | 2.25"     | 43.07" | 2.35"-46    | 9.14"       | 8.38"       | 8            | .73"      | 7.00"       | Taper     |
| 3202-C-9129 | 2.25"     | 43.07" | 2.35"-46    | 9.14"       | 8.38"       | 8            | .78"      | 7.00"       | Straight  |
| 3202-X-8110 | 2.25"     | 43.40" | 2.35"-46    | 3.03"       | 8.38"       | 8            | .73"      | 7.00"       | Taper     |
| 3202-Z-9490 | 2.25"     | 43.80" | 2.35"-46    | 3.03"       | 8.38"       | 8            | .64"      | 7.00"       | Straight  |
| 3202-G-9003 | 2.25"     | 43.80" | 2.35"-46    | 3.03"       | 8.38"       | 8            | .73"      | 7.00"       | Taper     |
| 3202-A-9491 | 2.25"     | 43.93" | 2.35"-46    | 9.14"       | 8.38"       | 8            | .64"      | 7.00"       | Straight  |
| 3202-B-8816 | 2.25"     | 43.93" | 2.35"-46    | 9.14"       | 8.38"       | 8            | .73"      | 7.00"       | Taper     |
| 3202-B-9128 | 2.25"     | 45.74" | 2.35"-46    | 3.03"       | 8.38"       | 8            | .78"      | 7.00"       | Straight  |
| 3202-A-9647 | 2.25"     | 45.90" | 2.35"-46    | 9.14"       | 8.38"       | 8            | .73"      | 7.00"       | Taper     |
| 3202-D-9130 | 2.25"     | 45.90" | 2.35"-46    | 9.14"       | 8.38"       | 8            | .78"      | 7.00"       | Straight  |
| 3202-F-9574 | 2.25"     | 46.61" | 2.35"-46    | 3.03"       | 8.38"       | 8            | .64"      | 7.00"       | Straight  |
| 3202-R-8806 | 2.25"     | 46.61" | 2.35"-46    | 3.03"       | 8.38"       | 8            | .73"      | 7.00"       | Taper     |
| 3202-G-9575 | 2.25"     | 46.78" | 2.35"-46    | 9.14"       | 8.38"       | 8            | .64"      | 7.00"       | Straight  |
| 3202-C-8817 | 2.25"     | 46.78" | 2.35"-46    | 9.14"       | 8.38"       | 8            | .73"      | 7.00"       | Taper     |
| 3202-Q-9403 | 2.25"     | 46.90" | 2.35"-46    | 9.14"       | 8.38"       | 8            | .73"      | 7.00"       | Taper     |
| 3206-T-1190 | 2.25"     | 49.67" | 2.35"-46    | 3.03"       | 8.38"       | 8            | .73"      | 7.00"       | Taper     |
| 3202-J-9916 | 2.25"     | 52.79" | 2.35"-46    | 3.03"       | 8.38"       | 8            | .73"      | 7.00"       | Taper     |
| 3202-L-9918 | 2.25"     | 52.92" | 2.35"-46    | 9.14"       | 8.38"       | 8            | .73"      | 7.00"       | Taper     |

# ROUND BEARING TYPE YOKES



| Axle Model (Location)                                       | Center to End | Spline Length | Hub Dia. | Bearing Cap Diameter | Yoke Dimension Across Ears | Spline Size Dia. - No. Teeth | Part Number  | Production Part Number |
|---|---------------|---------------|----------|----------------------|----------------------------|------------------------------|--------------|------------------------|
| Forward Input/<br>Rear Axle                                 | 4.94"         | 2.32"         | 3.25"    | 1.88"                | 5.31"                      | 2.38"-46                     | 16NYS38-8A   | A-3260-T-1034          |
|   | 6.19"         |               |          | 1.88"                | 5.31"                      |                              | 16NYS38-12A  | A-3260-G-1125          |
|   | 5.38"         |               |          | 1.94"                | 6.09"                      |                              | 17N-4-7181X  | A-3260-U-359           |
|   | 6.50"         |               |          | 1.94"                | 6.09"                      |                              | 17N-4-7771X  | A-3260-R-1058          |
|   | 5.06"         |               |          | 1.94"                | 7.00"                      |                              | 176NYS38-14A | A-3260-V-360           |
|   | 5.16"         |               |          | 1.94"                | 7.55"                      |                              | 18N-4-3731X  | A-3260-C-1147          |
| Forward Output/<br>Rear Axle                                | 5.54"         | 2.31"         | 3.00"    | 1.88"                | 5.31"                      | 2.00"-39                     | 16N-4-6271   | 3260-G-111             |
|   | 6.22"         |               |          | 1.88"                | 5.31"                      |                              | 16N-4-6241   | 3260-H-112             |
|   | 5.16"         |               |          | 1.94"                | 6.09"                      |                              | 17NYS32-100  | 3260-Q-121             |
|   | 6.25"         |               |          | 1.94"                | 6.09"                      |                              | 17NYS32-99   | 3260-P-120             |
| Rear Input/<br>Rear Axle and<br>Single Axle<br>Applications | 4.94"         | 2.32"         | 3.25"    | 1.88"                | 5.31"                      | 2.38"-46                     | 16NYS38-8A   | A-3260-T-1034          |
|   | 6.19"         |               |          | 1.88"                | 5.31"                      |                              | 16NYS38-12A  | A-3260-G-1125          |
|   | 5.38"         |               |          | 1.94"                | 6.09"                      |                              | 17N-4-7181X  | A-3260-U-359           |
|   | 6.50"         |               |          | 1.94"                | 6.09"                      |                              | 17NYS38-38A  | A-3260-R-1058          |
|   | 5.06"         |               |          | 1.94"                | 7.00"                      |                              | 176NYS38-14A | A-3260-V-360           |
|   | 5.16"         |               |          | 1.94"                | 7.55"                      |                              | 18NYS38-27A  | A-3260-C-1147          |

For additional: Parts Information  
 Cross Reference  
 Production Bills of Material

visit our online catalog at: [XpresswayPlus.ArvinMeritor.com](http://XpresswayPlus.ArvinMeritor.com)

# WING BEARING TYPE YOKES

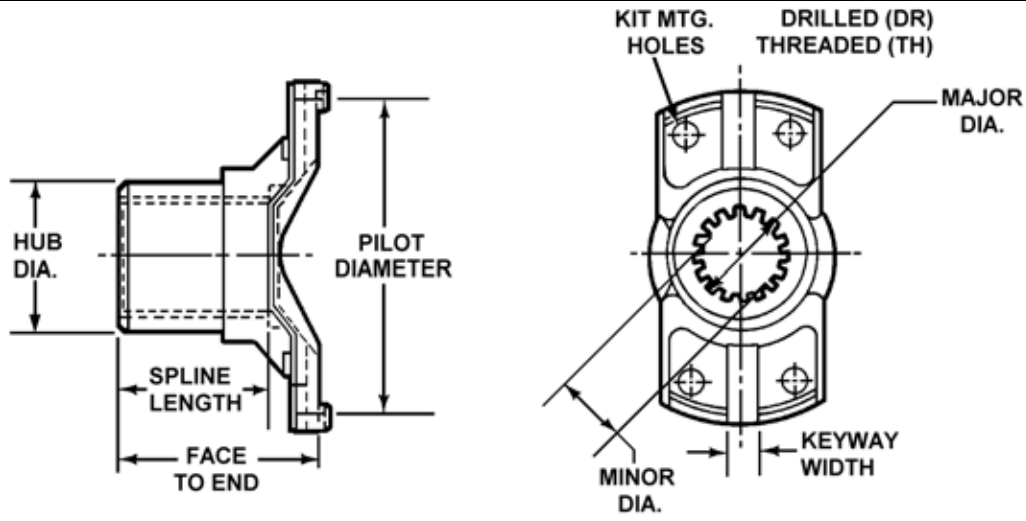

| Axle Model (Location)                                       | Face to End | Spline Length | Hub Dia. | Pilot Diameter | Keyway Width | Spline Size Dia. - No. Teeth | Hole Type | Part Number | Production Part Number |
|---|-------------|---------------|----------|----------------|--------------|------------------------------|-----------|-------------|------------------------|
| Forward Input/<br>Rear Axle                                 | 4.25"       | 2.32"         | 3.25"    | 5.84"          | .63"         | 2.38"-46                     | TH        | 72NYS38-26A | A-3260-B-1146          |
|   | 4.25"       | 2.32"         | 3.25"    | 8.13"          | .63"         | 2.38"-46                     | TH        | 82NYS38-31A | A-3260-H-1308          |
|   | 4.22"       | 2.32"         | 3.25"    | 8.25"          | .63"         | 2.38"-46                     | TH        | 92NYS38-73A | A-3260-K-1129          |
| Forward Output/<br>Rear Axle                                | 3.81"       | 2.31"         | 3.00"    | 5.84"          | .63"         | 2.00"-39                     | TH        | 72NYS32-244 | 3260-S-123             |
|   | 4.44"       | 2.31"         | 3.00"    | 8.25"          | .63"         | 2.00"-39                     | DR        | 92NYS32-26  | 3260-B-132             |
| Rear Input/<br>Rear Axle and<br>Single Axle<br>Applications | 4.25"       | 2.32"         | 3.25"    | 5.84"          | .63"         | 2.38"-46                     | TH        | 72NYS38-26A | A-3260-B-1146          |
|   | 4.25"       | 2.32"         | 3.25"    | 5.84"          | .63"         | 2.38"-46                     | DR        | 72NYS38-24A | A-3260-Z-1144          |
|   | 4.25"       | 2.32"         | 3.25"    | 8.13"          | .63"         | 2.38"-46                     | TH        | 82NYS38-31A | A-3260-H-1308          |
|   | 4.22"       | 2.32"         | 3.25"    | 8.25"          | .63"         | 2.38"-46                     | TH        | 92NYS38-73A | A-3260-K-1129          |



# MERITOR

an **ArvinMeritor** brand

# EASY SERVICE (STRAP) TYPE YOKES



| Axle Model (Location)                                       | Center to End | Spline Length | Hub Dia. | Bearing Cap Diameter | Distance Between Nibbs | Spline Size Dia. - No. Teeth | Hole Type | Part Number   | Production Part Number |
|---|---------------|---------------|----------|----------------------|------------------------|------------------------------|-----------|---------------|------------------------|
| Forward Input/<br>Rear Axle                                 | 5.38"         | 2.32"         | 3.25"    | 1.94"                | 6.19"                  | 2.38"-46                     | TH        | 17N-4-7181-1X | A-3260-G-1229          |
|   | 5.06"         |               |          | 1.94"                | 7.09"                  |                              | TH        | 176TYS38-27A  | A-3260-P-1264          |
|   | 5.16"         |               |          | 1.93"                | 7.64"                  |                              | TH        | 18N-4-3731-1X | A-3260-L-1260          |
| Forward Output/<br>Rear Axle                                | 6.22"         | 2.31"         | 3.00"    | 1.88"                | 5.31"                  | 2.00"-39                     | TH        | 16TYS32-76    | 3260-D-1668            |
|   | 6.25"         |               |          | 1.94"                | 6.19"                  |                              | TH        | 17TYS32-99    | 3260-A-1535            |
|   | 5.16"         |               |          | 1.94"                | 6.19"                  |                              | TH        | 17N-4-7621-1  | 3260-R-1292            |
| Rear Input/<br>Rear Axle and<br>Single Axle<br>Applications | 4.94"         | 2.32"         | 3.25"    | 1.88"                | 5.31"                  | 2.38"-46                     | TH        | 16N-4-7341-1X | A-3260-L-1234          |
|   | 5.38"         |               |          | 1.94"                | 6.19"                  |                              | TH        | 17TYS38-76A   | A-3260-G-1229          |
|   | 5.06"         |               |          | 1.94"                | 7.09"                  |                              | TH        | 176TYS38-27A  | A-3260-P-1264          |
|   | 5.16"         |               |          | 1.93"                | 7.64"                  |                              | TH        | 18TYS38-27A   | A-3260-L-1260          |



If you detect any **errors** in this catalog, please let us know.

We want the information to be as accurate as possible; we appreciate your help in making it so.

Please e-mail any comments/suggestions/corrections to us at: [catalogfeedback@arvinmeritor.com](mailto:catalogfeedback@arvinmeritor.com)

or mail to: ArvinMeritor  
attn: Catalog Dept.  
7975 Dixie Highway  
Florence, KY 41042

# COMPANION FLANGES



| Axle Model (Location)                                       | Face to End | Spline Length | Hub Dia. | Pilot Dia.<br>M=Male<br>F=Female | Flange Dia. | Hole Size | Bolt Circle Dia. | Spline Size<br>Dia. - No. Teeth | Part Number | Production Part Number |
|---|-------------|---------------|----------|----------------------------------|-------------|-----------|------------------|---------------------------------|-------------|------------------------|
| Forward Input/<br>Rear Axle                                 | 3.88"       | 2.32"         | 3.25"    | F-7.75"                          | 8.00"       | .38"      | 7.25"            | 2.38"-46                        | 5WCS38-18A  | A-3280-W-8265          |
| Rear Input/<br>Rear Axle and<br>Single Axle<br>Applications | 3.56"       | 2.32"         | 3.25"    | F-7.75"                          | 8.00"       | .44"      | 7.25"            | 2.38"-46                        | 5WCS38-23A2 | A2-3260-R-1240         |
|   | 3.88"       |               |          |                                  |             | .38"      |                  |                                 | 5WCS38-18A  | A-3280-W-8265          |

***XpresswayPlus.ArvinMeritor.com***



**XpresswayPlus.ArvinMeritor.com**  
For all of your parts-ordering needs

Don't forget about using *XpresswayPlus* for:

- Ordering parts online
- Order status
- Price and availability
- Invoice Lookup
- Parts Catalog
- Online e-mail or phone numbers for Customer Service, Information Services, Marketing, Catalog, and eSupport
- Reference Library
- The Company Store
- Literature
- Dealer/Distributor locator

XpresswayPlus is easy to use, can reduce phone calls, and save you valuable time.

## AXLE MODEL TO CARRIER TO KIT CROSS REFERENCE

| AXLE MODEL  | BASE CARRIER             | KIT DESCRIPTION   | KIT NUMBER   |
|-------------|--------------------------|---|--------------|
| Single Axle | 3200-C-1511 Standard     | Pinion bearing cage shims                                   | KIT 1592     |
| RC-23-160   | 3200-C-1511 Diff. lock   | Pinion bearing spacers                                      | KIT 1593     |
| RS-23-160   |                          | Ring gear to case fastener kit, prior to 4/88               | KIT 2317     |
| RS-23-161   |                          | Main diff. nest kit with spider                             | KIT 2318     |
| RS-24-160   |                          | Main diff. nest kit less spider                             | KIT 2341     |
| RS-25-160   |                          | Main diff. lock actuator kit (minor)                        | KIT 2406     |
| RS-26-160   |                          | Main diff. lock actuator                                    | KIT 2414     |
|             |                          | Ring gear to case fasteners after 4/88                      | KIT 2426     |
|             |                          | Diff. case assembly kit                                     | KIT 2796     |
|             |                          | Main diff. lock piston kit                                  | KIT 2614     |
|             |                          | Diff. case and gearset upgrade                              | KIT 2655-391 |
|             |                          | Diff. case and gearset upgrade                              | KIT 2655-410 |
|             |                          | Diff. case and gearset upgrade                              | KIT 2655-430 |
|             |                          | Diff. case and gearset upgrade                              | KIT 2655-456 |
|             |                          | Replaces A2-3200-C-1511 fast ratios, less diff. lock.       | KIT 2657     |
|             |                          | Replaces A2-3200-C-1511 mid range ratios, less diff. lock.  | KIT 2657A    |
|             |                          | Replaces A2-3200-C-1511 std. range ratios, less diff. lock. | KIT 2657B    |
|             |                          | Replaces A2-3200-C-1511 fast ratios, with diff. lock.       | KIT 2658     |
|             |                          | Replaces A2-3200-C-1511 mid range ratios, with diff. lock.  | KIT 2658A    |
|             |                          | Replaces A2-3200-C-1511 std. ratios, with diff. lock.       | KIT 2658B    |
|             |                          | Lock pin kit (non-ABS carriers only)                        | KIT 4284     |
|             |                          | Bearing and seal kit  | KIT 4415     |
|             |                          | Major overhaul kit  | KIT RR23160  |
|             | 3200-Z-1560 Standard     | Pinion bearing cage shims                                   | KIT 1592     |
|             | 3200-Z-1560 Diff. Lock   | Pinion bearing spacers                                      | KIT 1593     |
|             | 3200-Z-1560 NoSpin diff. | Ring gear to case fastener kit, prior to 4/88               | KIT 2317     |
|             |                          | Main diff. nest kit with spider *                           | KIT 2318     |
|             |                          | Main diff. nest kit less spider *                           | KIT 2341     |
|             |                          | Main diff. lock actuator kit (minor)                        | KIT 2406     |
|             |                          | Ring gear to case fasteners after 4/88                      | KIT 2426     |
|             |                          | Diff. case assembly kit                                     | KIT 2796     |
|             |                          | Main diff. lock piston kit                                  | KIT 2614     |
|             |                          | Diff. case and gearset upgrade                              | KIT 2468-391 |
|             |                          | Diff. case and gearset upgrade                              | KIT 2468-410 |
|             |                          | Diff. case and gearset upgrade                              | KIT 2468-430 |
|             |                          | Diff. case and gearset upgrade                              | KIT 2468-456 |
|             |                          | Replaces A2-3200-Z-1560 fast ratios, less diff. lock.       | KIT 2642     |
|             |                          | Replaces A2-3200-Z-1560 mid range ratios, less diff. lock.  | KIT 2642A    |
|             |                          | Replaces A2-3200-Z-1560 std. ratios, less diff. lock.       | KIT 2642B    |
|             |                          | Replaces A2-3200-Z-1560 fast ratios, with diff. lock.       | KIT 2643     |
|             |                          | Replaces A2-3200-Z-1560 mid range ratios, with diff. lock.  | KIT 2643A    |
|             |                          | Replaces A2-3200-Z-1560 std. ratios, with diff. lock.       | KIT 2643B    |
|             |                          | Lock pin kit (non-ABS carriers only)                        | KIT 4284     |
|             |                          | Bearing and seal kit  | KIT 4415     |
|             |                          | Major overhaul kit  | KIT RR23160  |
|             | 3200-T-1658 Standard     | Pinion bearing cage shims                                   | KIT 1592     |
|             | 3200-T-1658 NoSpin diff. | Pinion bearing spacers                                      | KIT 1593     |
|             |                          | Ring gear to case fastener kit, prior to 4/88               | KIT 2317     |
|             |                          | Main diff. nest kit with spider *                           | KIT 2318     |
|             |                          | Main diff. nest kit less spider *                           | KIT 2341     |
|             |                          | Ring gear to case fasteners after 4/88                      | KIT 2426     |
|             |                          | Diff. case assembly kit                                     | KIT 2796     |
|             |                          | Replaces A2-3200-T-1658 fast ratios, less diff. lock.       | KIT 2642     |
|             |                          | Replaces A2-3200-T-1658 mid range ratios, less diff. lock.  | KIT 2642A    |
|             |                          | Replaces A2-3200-T-1658 std. range ratios, less diff. lock. | KIT 2642B    |
|             |                          | Lock pin kit (non-ABS carriers only)                        | KIT 4284     |
|             |                          | Bearing and seal kit  | KIT 4415     |
|             |                          | Major overhaul kit  | KIT RR23160  |

\* Diff. nest kit not required with NoSpin.



## AXLE MODEL TO CARRIER TO KIT CROSS REFERENCE

| AXLE MODEL  | BASE CARRIER             | KIT DESCRIPTION   | KIT NUMBER   |
|-------------|--------------------------|---|--------------|
| Single Axle | 3200-R-1708 Diff. lock   | Pinion bearing cage shims                                       | KIT 1592     |
| RC-23-160   | 3200-C-1823 Diff. lock   | Pinion bearing spacers  | KIT 1593     |
| RS-23-160   | 3200-T-1892 Diff. lock   | Main diff. nest kit w ith spider                                | KIT 2318     |
| RS-23-161   | 3200-D-1928 Diff. lock   | Main diff. nest kit less spider                                 | KIT 2341     |
| RS-24-160   |                          | Main diff. lock actuator kit (minor) (all except 3200-T-1892)   | KIT 2406     |
| RS-25-160   |                          | Main diff. lock actuator kit (minor) (3200-T-1892)              | KIT 2750     |
| RS-26-160   |                          | Ring gear to case fasteners after 4/88                          | KIT 2426     |
|             |                          | Diff. case assembly kit   | KIT 2796     |
|             |                          | Main diff. lock piston kit (all except 3200-T-1892)             | KIT 2614     |
|             |                          | Main diff. lock piston kit (3200-T-1892)                        | KIT 2691     |
|             |                          | Main diff. lock actuator kit (all except 3200-T-1892)           | KIT 2615     |
|             |                          | Main diff. lock actuator kit (3200-T-1892)                      | KIT 2698     |
|             |                          | Replaces A2-3200-R-1708   | KIT 2659     |
|             |                          | Lock pin kit (non-ABS carriers only)                            | KIT 4284     |
|             |                          | Bearing and seal kit  | KIT 4428     |
|             |                          | Main diff. lock kit (3200-T-1892, 3200-D-1928)                  | KIT 2698     |
|             |                          | Major overhaul kit  | KIT RR23160B |
|             |                          | Replaces A2-3200-C-1823   | KIT 2762     |
|             | 3200-P-1706 Standard     | Pinion bearing cage shims                                       | KIT 1592     |
|             | 3200-H-1854 Standard     | Pinion bearing spacers  | KIT 1593     |
|             | 3200-J-1856 Standard     | Main diff. nest kit w ith spider *                              | KIT 2318     |
|             |                          | Main diff. nest kit less spider *                               | KIT 2341     |
|             | 3200-P-1706 NoSpin diff. | Ring gear to case fasteners after 4/88                          | KIT 2426     |
|             | 3200-A-1821 NoSpin diff. | Diff. case assembly kit   | KIT 2796     |
|             |                          | Lock pin kit (non-ABS carriers only)                            | KIT 4284     |
|             |                          | Bearing and seal kit  | KIT 4426     |
|             |                          | Major overhaul kit  | KIT RR23160A |
|             | 3200-V-1712 Standard     | Pinion bearing cage shims                                       | KIT 1592     |
|             | 3200-Y-1897 Standard     | Pinion bearing spacers  | KIT 1593     |
|             | 3200-E-1929 Standard     | Main diff. nest kit w ith spider *                              | KIT 2318     |
|             |                          | Main diff. nest kit less spider *                               | KIT 2341     |
|             | 3200-V-1712 Diff. lock   | Ring gear to case fasteners after 4/88                          | KIT 2426     |
|             | 3200-Y-1897 Diff. lock   | Diff. case assembly kit   | KIT 2796     |
|             | 3200-E-1929 Diff. lock   | Main diff. lock piston kit (all except 3200-Y-1897,3200-E-1929) | KIT 2614     |
|             |                          | Main diff. lock actuator (all except 3200-Y-1897,3200-E-1929)   | KIT 2615     |
|             | 3200-V-1712 NoSpin diff. | Main diff. lock kit (3200-Y-1897,3200-E-1929)                   | KIT 2698     |
|             | 3200-E-1825 NoSpin diff. | Lock pin kit (non-ABS carriers only)                            | KIT 4284     |
|             |                          | Bearing and seal kit  | KIT 4428     |
|             |                          | Major overhaul kit  | KIT RR23160B |
|             | 3200-V-1660 Diff. lock   | Pinion bearing cage shims                                       | KIT 1592     |
|             |                          | Pinion bearing spacers  | KIT 1593     |
|             |                          | Ring gear to case fastener kit, prior to 4/88                   | KIT 2317     |
|             |                          | Main diff. nest kit w ith spider                                | KIT 2318     |
|             |                          | Main diff. nest kit less spider                                 | KIT 2341     |
|             |                          | Main diff. lock actuator kit (minor)                            | KIT 2406     |
|             |                          | Main diff. lock actuator kit                                    | KIT 2414     |
|             |                          | Ring gear to case fasteners after 4/88                          | KIT 2426     |
|             |                          | Diff. case assembly kit   | KIT 2796     |
|             |                          | Main diff. lock piston kit                                      | KIT 2614     |
|             |                          | Replaces A2-3200-Z-1560 fast ratios, w ith diff. lock.          | KIT 2643     |
|             |                          | Replaces A2-3200-Z-1560 mid range ratios, w ith diff. lock.     | KIT 2643A    |
|             |                          | Replaces A2-3200-Z-1560 std. ratios, w ith diff. lock.          | KIT 2643B    |
|             |                          | Lock pin kit (non-ABS carriers only)                            | KIT 4284     |
|             |                          | Bearing and seal kit  | KIT 4415     |
|             |                          | Major overhaul kit  | KIT RR23160  |

\* Diff. nest kit not required w ith NoSpin.

## AXLE MODEL TO CARRIER TO KIT CROSS REFERENCE

| AXLE MODEL   | BASE CARRIER   | KIT DESCRIPTION                                  | KIT NUMBER                         |          |
|--|--|--|------------------------------------|----------|
| Front<br>RD-20-160<br>RD-23-160<br>RD-23-164<br>RD-26-160<br>RD-25-160   | 3200-J-1648 Standard   | Thru-shaft bearing preload spacers               | KIT 576                            |          |
|  | 3200-J-1648 NoSpin diff.   | Ring gear to case fastener kit, prior to 4/88    | KIT 2317                           |          |
|  |  | Main diff. nest kit with spider *                | KIT 2318                           |          |
|  |  | Main diff. nest kit less spider *                | KIT 2341                           |          |
|  |  | Pinion bearing spacers                           | KIT 2397                           |          |
|  |  | I.A.D nest with spider                           | KIT 2424                           |          |
|  |  | Ring gear to case fasteners after 4/88           | KIT 2426                           |          |
|  |  | Input and pinion shims                           | KIT 2429                           |          |
|  |  | Helical gear kit                                 | KIT 2483                           |          |
|  |  | I.A.D. nest less spider                          | KIT 2489                           |          |
|  |  | Output nut and washer upgrade                    | KIT 2637                           |          |
|  |  | Input shaft nut and washer upgrade               | KIT 2638                           |          |
|  |  | Replaces A2-3200-J-1648 fast ratios              | KIT 2644                           |          |
|  |  | Replaces A2-3200-J-1648 mid range ratios         | KIT 2644A                          |          |
|  |  | Replaces A2-3200-J-1648 std. ratios              | KIT 2644B                          |          |
|  |  | Lock pin kit (non-ABS carriers only)             | KIT 4284                           |          |
|  |  | Bearing and seal kit                             | KIT 4420                           |          |
|  |  | Overhaul kit                                     | KIT RP23160A                       |          |
|  |  | 3200-M-1703 Standard<br>3200-M-1703 NoSpin diff. | Thru-shaft bearing preload spacers | KIT 576  |
|  |  |  | Main diff. nest kit with spider *  | KIT 2318 |
|  | Main diff. nest kit less spider *                                      |  | KIT 2341                           |          |
| Pinion bearing spacers   | KIT 2397   |  |                                    |          |
| I.A.D nest with spider   | KIT 2424   |  |                                    |          |
| Ring gear to case fasteners after 4/88   | KIT 2426   |  |                                    |          |
| Input and pinion shims   | KIT 2429   |  |                                    |          |
| Helical gear kit   | KIT 2483   |  |                                    |          |
| I.A.D. nest less spider  | KIT 2489   |  |                                    |          |
| Replaces A2-3200-M-1703  | KIT 2618   |  |                                    |          |
| Output nut and washer upgrade  | KIT 2637   |  |                                    |          |
| Input shaft nut and washer upgrade   | KIT 2638   |  |                                    |          |
| Lock pin kit (non-ABS carriers only)   | KIT 4284   |  |                                    |          |
| Bearing and seal kit   | KIT 4422   |  |                                    |          |
| Overhaul kit   | KIT RP23160A   |  |                                    |          |
| 3200-X-1818 Standard<br>3200-K-1857 Standard<br>3200-Q-1837 Standard<br>3200-J-2116 Standard<br><br>3200-X-1818 NoSpin diff.<br>3200-J-2116 NoSpin diff. | Thru-shaft bearing preload spacers                                     | KIT 576  |                                    |          |
|  | Main diff. nest kit with spider *                                      | KIT 2318   |                                    |          |
|  | Main diff. nest kit less spider *                                      | KIT 2341   |                                    |          |
|  | Pinion bearing spacers   | KIT 2397   |                                    |          |
|  | I.A.D nest with spider   | KIT 2424   |                                    |          |
|  | Ring gear to case fasteners after 4/88                                 | KIT 2426   |                                    |          |
|  | Input and pinion shims   | KIT 2429   |                                    |          |
|  | Helical gear kit   | KIT 2483   |                                    |          |
|  | I.A.D. nest less spider  | KIT 2489   |                                    |          |
|  | Output nut and washer upgrade  | KIT 2637   |                                    |          |
|  | Input shaft nut and washer upgrade                                     | KIT 2638   |                                    |          |
|  | Lock pin kit (non-ABS carriers only)                                   | KIT 4284   |                                    |          |
|  | Tapered dowel Kit (3200-X-1818)  | KIT 4288   |                                    |          |
|  | Bearing and seal kit   | KIT 4422   |                                    |          |
|  | Overhaul kit   | KIT RP23160A                                     |                                    |          |
|  | Front<br>RD-20-160<br>RD-23-160<br>RD-23-164<br>RD-26-160<br>RD-25-160 | 3200-W-1713 Diff. lock                           | Thru-shaft bearing preload spacers | KIT 576  |
|  |  |  | Main diff. nest kit with spider    | KIT 2318 |
| Main diff. nest kit less spider  |  |  | KIT 2341                           |          |
| Pinion bearing spacers   |  |  | KIT 2397                           |          |
| Main diff. lock actuator kit (minor)   |  |  | KIT 2406                           |          |
| I.A.D nest with spider   |  |  | KIT 2424                           |          |

\* Diff. nest kit not required with NoSpin.

## AXLE MODEL TO CARRIER TO KIT CROSS REFERENCE

| AXLE MODEL   | BASE CARRIER   | KIT DESCRIPTION                                       | KIT NUMBER   |
|--|--|---|--------------|
| Front<br>RD-20-160<br>RD-23-160<br>RD-23-164<br>RD-26-160<br>RD-25-160<br>(Cont.)  | 3200-W-1713 Diff. lock<br>(Continued)                                      | Ring gear to case fasteners after 4/88                | KIT 2426     |
|  |  | Input and pinion shims                                | KIT 2429     |
|  |  | Helical gear kit                                      | KIT 2483     |
|  |  | I.A.D. nest less spider                               | KIT 2489     |
|  |  | Main diff. lock piston kit                            | KIT 2614     |
|  |  | Main diff. lock actuator kit                          | KIT 2615     |
|  |  | Output nut and washer upgrade                         | KIT 2637     |
|  |  | Input shaft nut and washer upgrade                    | KIT 2638     |
|  |  | Lock pin kit (non-ABS carriers only)                  | KIT 4284     |
|  |  | Bearing and seal kit                                  | KIT 4423     |
|  |  | Overhaul kit  | KIT RP23160B |
|  | 3200-Y-1819 Diff. lock<br>3200-W-1895 Diff. lock<br>3200-L-2118 Diff. lock | Thru-shaft bearing preload spacers                    | KIT 576      |
|  |  | Main diff. nest kit with spider                       | KIT 2318     |
|  |  | Main diff. nest kit less spider                       | KIT 2341     |
|  |  | Pinion bearing spacers                                | KIT 2397     |
|  |  | Main diff. lock actuator kit (minor)                  | KIT 2406     |
|  |  | I.A.D nest with spider                                | KIT 2424     |
|  |  | Ring gear to case fasteners after 4/88                | KIT 2426     |
|  |  | Input and pinion shims                                | KIT 2429     |
|  |  | Helical gear kit                                      | KIT 2483     |
|  |  | I.A.D. nest less spider                               | KIT 2489     |
|  |  | Main diff. lock piston kit (all except 3200-W-1895)   | KIT 2614     |
|  |  | Main diff. lock actuator kit (all except 3200-W-1895) | KIT 2615     |
|  |  | Output nut and washer upgrade                         | KIT 2637     |
| Input shaft nut and washer upgrade   |  | KIT 2638  |              |
| Main diff. lock piston kit (3200-W-1895)   |  | KIT 2691  |              |
| Lock pin kit (non-ABS carriers only)   |  | KIT 4284  |              |
| Tapered dowel kit (3200-L-2118)  |  | KIT 4288  |              |
| Bearing and seal kit   |  | KIT 4423  |              |
| Overhaul kit   |  | KIT RP23160B  |              |
| Replaces A2-3200-Y-1819  | KIT 2764   |   |              |
| 3200-P-1628 Standard<br>3200-P-1628 NoSpin diff.<br>3200-P-1628 Pump<br>3200-P-1628 Pump w/diff. lock<br>3200-P-1628 Pump w/NoSpin | Thru-shaft bearing preload spacers   | KIT 576   |              |
|  | Ring gear to case fastener kit, prior to 4/88                              | KIT 2317  |              |
|  | Main diff. nest kit with spider *  | KIT 2318  |              |
|  | Main diff. nest kit less spider *  | KIT 2341  |              |
|  | Pinion bearing spacers   | KIT 2397  |              |
|  | Main diff. lock actuator kit (minor)                                       | KIT 2406  |              |
|  | Main diff. lock actuator kit   | KIT 2414  |              |
|  | I.A.D nest with spider   | KIT 2424  |              |
|  | Ring gear to case fasteners after 4/88                                     | KIT 2426  |              |
|  | Input and pinion shims   | KIT 2429  |              |
|  | Helical gear kit   | KIT 2483  |              |
|  | I.A.D. nest less spider  | KIT 2489  |              |
|  | Main diff. lock piston kit   | KIT 2614  |              |
|  | Input shaft and pump upgrade kit   | KIT 2624  |              |
|  | Output nut and washer upgrade  | KIT 2637  |              |
|  | Input shaft nut and washer upgrade   | KIT 2638  |              |
|  | Replaces A2-3200-P-1628, fast ratios, with diff. lock                      | KIT 2640  |              |
|  | Replaces A2-3200-P-1628, mid-range ratios, with diff. lock                 | KIT 2640A   |              |
|  | Replaces A2-3200-P-1628, std. ratios, with diff. lock                      | KIT 2640B   |              |
|  | Replaces A2-3200-P-1628, fast ratios, less diff. lock                      | KIT 2641  |              |
|  | Replaces A2-3200-P-1628, mid-range ratios, less diff. lock                 | KIT 2641A   |              |
| Replaces A2-3200-P-1628, std. ratios, less diff. lock  | KIT 2641B  |   |              |
| Lock pin kit (non-ABS carriers only)   | KIT 4284   |   |              |
| Bearing and seal kit   | KIT 4420   |   |              |
| Overhaul kit   | KIT RP23160  |   |              |

\* Diff. nest kit not required with NoSpin.

## AXLE MODEL TO CARRIER TO KIT CROSS REFERENCE

| AXLE MODEL | BASE CARRIER                  | KIT DESCRIPTION   | KIT NUMBER   |
|------------|-------------------------------|---|--------------|
| Front      | 3200-K-1701 Pump              | Thru-shaft bearing preload spacers                            | KIT 576      |
| RP-20-160  | 3200-K-1701 Pump w/diff. lock | Main diff. nest kit with spider *                             | KIT 2318     |
| RP-23-160  | 3200-K-1701 Pump w/NoSpin     | Main diff. nest kit less spider *                             | KIT 2341     |
| RP-23-164  |                               | Pinion bearing spacers  | KIT 2397     |
| RP-25-160  |                               | Main diff. lock actuator kit (minor)                          | KIT 2406     |
| RP-26-160  |                               | I.A.D nest with spider  | KIT 2424     |
|            |                               | Ring gear to case fasteners after 4/88                        | KIT 2426     |
|            |                               | Input and pinion shims  | KIT 2429     |
|            |                               | Helical gear kit  | KIT 2483     |
|            |                               | I.A.D. nest less spider                                       | KIT 2489     |
|            |                               | Main diff. lock piston kit                                    | KIT 2614     |
|            |                               | Main diff. lock actuator kit                                  | KIT 2615     |
|            |                               | Replaces A2-3200-K-1701                                       | KIT 2616     |
|            |                               | Output nut and washer upgrade                                 | KIT 2637     |
|            |                               | Input shaft nut and washer upgrade                            | KIT 2638     |
|            |                               | Lock pin kit (non-ABS carriers only)                          | KIT 4284     |
|            |                               | Bearing and seal kit  | KIT 4423     |
|            |                               | Overhaul kit  | KIT RP23160B |
|            | 3200-Z-1820 Pump              | Thru-shaft bearing preload spacers                            | KIT 576      |
|            | 3200-V-1894 Pump              | Main diff. nest kit with spider *                             | KIT 2318     |
|            | 3200-K-2117 Pump              | Main diff. nest kit less spider *                             | KIT 2341     |
|            |                               | Pinion bearing spacers  | KIT 2397     |
|            | 3200-Z-1820 Pump w/diff. lock | Main diff. lock actuator kit (minor) (all except 3200-V-1894) | KIT 2406     |
|            | 3200-V-1894 Pump w/diff. lock | Main diff. lock actuator kit (minor) (3200-V-1894)            | KIT 2750     |
|            | 3200-K-2117 Pump w/diff. lock | I.A.D nest with spider  | KIT 2424     |
|            |                               | Ring gear to case fasteners after 4/88                        | KIT 2426     |
|            | 3200-Z-1820 Pump w/NoSpin     | Input and pinion shims  | KIT 2429     |
|            | 3200-V-1894 Pump w/NoSpin     | Helical gear kit  | KIT 2483     |
|            | 3200-K-2117 Pump w/NoSpin     | I.A.D. nest less spider                                       | KIT 2489     |
|            |                               | Main diff. lock piston kit (all except 3200-V-1894)           | KIT 2614     |
|            |                               | Main diff. lock piston kit (3200-V-1894)                      | KIT 2691     |
|            |                               | Main diff. lock actuator kit (all except 3200-V-1894)         | KIT 2615     |
|            |                               | Main diff. lock actuator kit (3200-V-1894)                    | KIT 2698     |
|            |                               | Output nut and washer upgrade                                 | KIT 2637     |
|            |                               | Input shaft nut and washer upgrade                            | KIT 2638     |
|            |                               | Lock pin kit (non-ABS carriers only)                          | KIT 4284     |
|            |                               | Tapered dowel kit (3200-K-2117)                               | KIT 4288     |
|            |                               | Bearing and seal kit  | KIT 4423     |
|            |                               | Overhaul kit  | KIT RP23160B |
|            |                               | Replaces A2-3200-Z-1820 less diff. lock                       | KIT 2766     |
|            |                               | Replaces A2-3200-Z-1820 with diff. lock                       | KIT 2763     |
| Rear       | All                           | Use the carriers and kits in the RS-23-160 section            | ---          |
| RR-20-160  |                               |   |              |
| RR-23-160  |                               |   |              |
| RR-23-164  |                               |   |              |
| RR-25-160  |                               |   |              |
| RR-26-160  |                               |   |              |

\* Diff. nest kit not required with NoSpin.

# SERVICE KITS

## KIT RP23160

| ITEM | PART NUMBER | QTY. | DESCRIPTION                | REMARKS   |
|------|-------------|------|----------------------------|---|
| 1    | 40-X-1145   | 1    | Nut                        | Forward-rear carriers with I.A.D. and without main diff. lock.<br>RP-23-160, RP-23-164, RP-26-160<br>3200-J-1648, 3200-P-1628 |
| 2    | KIT 2318    | 1    | Main diff. kit with spider |   |
| 3    | KIT 2424    | 1    | IAD Kit with Spider        |   |
| 4    | KIT 2429    | 1    | Shim Kit                   |   |
| 5    | KIT 2637    | 1    | Input Nut and Washer Kit   |   |
| 6    | 40-X-1233   | 1    | Pinion Nut                 |   |
| 7    | 1229-N-1730 | 1    | Pinion Washer              |   |
| 8    | KIT 2397    | 1    | Spacer Kit                 |   |
| 9    | KIT 4420    | 1    | Bearing & Seal Kit         |   |

## KIT RP23160A

| ITEM | PART NUMBER | QTY. | DESCRIPTION                | REMARKS   |
|------|-------------|------|----------------------------|---|
| 1    | 40-X-1145   | 1    | Nut                        | Forward-rear carriers with I.A.D. and without main diff. lock.<br>RD-23-160, RD-23-164, RD-26-160<br>3200-M-1703, 3200-Q-1837, 3200-X-1818, 3200-J-2116 |
| 2    | 40-X-1233   | 1    | Lock Nut                   |   |
| 3    | 1229-N-1730 | 1    | Washer                     |   |
| 4    | KIT 2318    | 1    | Main diff. kit with spider |   |
| 5    | KIT 2424    | 1    | IAD Kit with Spider        |   |
| 6    | KIT 2429    | 1    | Shim Kit                   |   |
| 7    | KIT 2637    | 1    | Input Nut and Washer Kit   |   |
| 8    | KIT 2397    | 1    | Spacer Kit                 |   |
| 9    | KIT 4422    | 1    | Bearing & Seal Kit         |   |

## KIT RP23160B

| ITEM | PART NUMBER | QTY. | DESCRIPTION                | REMARKS   |
|------|-------------|------|----------------------------|---|
| 1    | 40-X-1145   | 1    | Nut                        | Forward-rear carriers with I.A.D. and with main diff. lock.<br>RD-23-160, RD-23-164, RD-26-160, RP-23-160, RP-23-164,<br>RP-26-160<br>3200-J-1908, 3200-K-1701, 3200-K-1909, 3200-V-1894,<br>3200-W-1713, 3200-W-1895, 3200-Y-1819, 3200-Z-1820 |
| 2    | 40-X-1233   | 1    | Lock Nut                   |   |
| 3    | 1229-N-1730 | 1    | Washer                     |   |
| 4    | KIT 2318    | 1    | Main diff. kit with spider |   |
| 5    | KIT 2397    | 1    | Spacer Kit                 |   |
| 6    | KIT 2424    | 1    | IAD Kit with Spider        |   |
| 7    | KIT 2429    | 1    | Shim Kit                   |   |
| 8    | KIT 2637    | 1    | Input Nut and Washer Kit   |   |
| 9    | KIT 4423    | 1    | Bearing & Seal Kit         |   |

## KIT RR23160

| ITEM | PART NUMBER | QTY. | DESCRIPTION                | REMARKS  |
|------|-------------|------|----------------------------|--|
| 1    | KIT 1592    | 1    | Shim Kit                   | Single and rear-rear carriers without main diff. lock.<br>RS-23-160, RS-23-161, RS-25-160, RS-26-160<br>3200-C-1511, 3200-T-1658, 3200-V-1660, 3200-Z-1560 |
| 2    | KIT 1593    | 1    | Spacer Kit                 |  |
| 3    | KIT 2318    | 1    | Main diff. kit with spider |  |
| 4    | 40-X-1233   | 1    | Pinion Nut                 |  |
| 5    | 1229-N-1730 | 1    | Pinion Washer              |  |
| 6    | KIT 4415    | 1    | Bearing & Seal Kit         |  |

## KIT RR23160A

| ITEM | PART NUMBER | QTY. | DESCRIPTION                | REMARKS  |
|------|-------------|------|----------------------------|--|
| 1    | 40-X-1233   | 1    | Lock Nut                   | Single and rear-rear carriers without main diff. lock.<br>RS-23-160, RS-23-161, RS-25-160, RS-26-160<br>3200-A-1821, 3200-H-1854, 3200-J-1856, 3200-P-1706 |
| 2    | 1229-N-1730 | 1    | Washer                     |  |
| 3    | KIT 1592    | 1    | Shim Kit                   |  |
| 4    | KIT 1593    | 1    | Spacer Kit                 |  |
| 5    | KIT 2318    | 1    | Main diff. kit with spider |  |
| 6    | KIT 4426    | 1    | Bearing & Seal Kit         |  |

## KIT RR23160B

| ITEM | PART NUMBER | QTY. | DESCRIPTION                | REMARKS   |
|------|-------------|------|----------------------------|---|
| 1    | 40-X-1233   | 1    | Lock Nut                   | Single and rear-rear carriers with diff. lock.<br>RS-23-160, RS-23-161, RS-25-160, RS-26-160<br>3200-C-1823, 3200-D-1928, 3200-E-1825, 3200-E-1929,<br>3200-R-1708, 3200-T-1892, 3200-V-1712, 3200-Y-1897 |
| 2    | 1229-W-4521 | 1    | Washer                     |   |
| 3    | KIT 1592    | 1    | Shim Kit                   |   |
| 4    | KIT 1593    | 1    | Spacer Kit                 |   |
| 5    | KIT 2318    | 1    | Main diff. kit with spider |   |
| 6    | KIT 4428    | 1    | Bearing & Seal Kit         |   |

# SERVICE KITS

## KIT 576

| ITEM | PART NUMBER | QTY. | DESCRIPTION                 | REMARKS  |
|------|-------------|------|-----------------------------|--|
| 1    | 1229-P-2590 | 1    | Snap Ring - 3.94mm/.155 in. | Output shaft snap ring kit<br>RD-23-160, RD-23-164, RD-26-160, RP-23-160, RP-23-164, RP-26-160 |
| 2    | 1229-Q-2591 | 1    | Snap Ring - 4.01mm/.158 in. |  |
| 3    | 1229-R-2592 | 1    | Snap Ring - 4.09mm/.161 in. |  |
| 4    | 1229-S-2593 | 1    | Snap Ring - 4.17mm/.164 in. |  |
| 5    | 1229-T-2594 | 1    | Snap Ring - 4.24mm/.167 in. |  |
| 6    | 1229-U-2595 | 1    | Snap Ring - 4.32mm/.170 in. |  |
| 7    | 1229-V-2596 | 1    | Snap Ring - 4.39mm/.173 in. |  |
| 8    | 1229-W-2597 | 1    | Snap Ring - 4.47mm/.176 in. |  |
| 9    | 1229-X-2598 | 1    | Snap Ring - 4.55mm/.179 in. |  |
| 10   | 1229-Y-2599 | 1    | Snap Ring - 4.62mm/.182 in. |  |

## KIT 1592

| ITEM | PART NUMBER | QTY. | DESCRIPTION             | REMARKS                                    |
|------|-------------|------|-------------------------|--|
| 1    | 2803-Y-2755 | 4    | 0.002 in./0.050 mm Shim | RS-23-160, RS-23-161, RS-25-160, RS-26-160 |
| 2    | 2803-Z-2756 | 2    | 0.005 in./0.125 mm Shim |  |
| 3    | 2803-A-2757 | 4    | 0.008 in./0.200 mm Shim |  |
| 4    | 2803-B-2758 | 1    | 0.020 in./0.500 mm Shim |  |

## KIT 1593

| ITEM | PART NUMBER | QTY. | DESCRIPTION             | REMARKS  |
|------|-------------|------|-------------------------|--|
| 1    | 2803-D-2500 | 2    | .250 in./6.35 mm Spacer | Pinion bearing spacers<br>RR-23-160, RS-23-160, RS-23-161, RS-25-160, RS-26-160<br>3200-A-1821, 3200-A-1899, 3200-C-1511, 3200-C-1823,<br>3200-C-1831, 3200-D-1928, 3200-E-1825, 3200-E-1929,<br>3200-H-1854, 3200-J-1752, 3200-J-1804, 3200-J-1856,<br>3200-K-1753, 3200-P-1706, 3200-R-1708, 3200-S-1839,<br>3200-T-1658, 3200-T-1892, 3200-U-1399, 3200-V-1660,<br>3200-V-1712, 3200-W-1791, 3200-Y-1897, 3200-Z-1560 |
| 2    | 2803-E-2501 | 2    | .251 in./6.38 mm Spacer |  |
| 3    | 2803-F-2502 | 2    | .252 in./6.40 mm Spacer |  |
| 4    | 2803-N-2510 | 2    | .253 in./6.45 mm Spacer |  |
| 5    | 2803-G-2503 | 2    | .254 in./6.45 mm Spacer |  |
| 6    | 2803-H-2504 | 2    | .256 in./6.50 mm Spacer |  |
| 7    | 2803-J-2506 | 2    | .260 in./6.60 mm Spacer |  |
| 8    | 2803-K-2507 | 2    | .261 in./6.63 mm Spacer |  |
| 9    | 2803-L-2508 | 2    | .262 in./6.65 mm Spacer |  |
| 10   | 2803-M-2509 | 2    | .263 in./6.68 mm Spacer |  |

## KIT 2317

| ITEM | PART NUMBER | QTY. | DESCRIPTION | REMARKS   |
|------|-------------|------|-------------|---|
| 1    | 41-X-1216   | 12   | Capscrew    | Gear to case bolt kit (17.0 mm bolts prior to 4-88)<br>RD-23-160, RD-23-164, RD-26-160, RP-23-160, RP-23-164,<br>RP-26-160, RR-23-160, RR-23-164, RR-26-160, RS-23-160,<br>RS-25-160, RS-26-160 |
| 2    | 1229-U-1503 | 12   | Washer      |   |
| 3    | 40-X-1182   | 12   | Lock Nut    |   |

## KIT 2318

| ITEM | PART NUMBER | QTY. | DESCRIPTION                      | REMARKS  |
|------|-------------|------|----------------------------------|--|
| 1    | 2233-M-1001 | 4    | Differential Pinion, Finished    | Main diff. kit with spider.<br>RS-23-160, RS-23-161, RS-25-160 |
| 2    | 2234-C-1069 | 2    | Differential Side Gear, Finished |  |
| 3    | 3278-W-335  | 1    | Differential Spider              |  |
| 4    | 1229-L-3002 | 2    | Side Gear Thrust Washer          |  |
| 5    | 1229-K-3001 | 4    | Differential Pinion Washer       |  |

## KIT 2341

| ITEM | PART NUMBER | QTY. | DESCRIPTION                      | REMARKS  |
|------|-------------|------|----------------------------------|--|
| 1    | 1229-L-3002 | 2    | Side Gear Thrust Washer          | Main diff. kit less spider.<br>RS-23-160, RS-23-161, RS-25-160 |
| 2    | 2234-C-1069 | 2    | Differential Side Gear, Finished |  |
| 3    | 2233-M-1001 | 4    | Differential Pinion, Finished    |  |
| 4    | 1229-K-3001 | 4    | Differential Pinion Washer       |  |

# SERVICE KITS

## KIT 2397

| ITEM | PART NUMBER | QTY. | DESCRIPTION              | REMARKS  |
|------|-------------|------|--------------------------|--|
| 1    | 2203-V-9824 | 2    | .451 in./11.45 mm Spacer | Pinion bearing spacers<br>RD-23-160, RD-23-164, RD-26-160, RP-23-160, RP-23-164, RP-26-160 |
| 2    | 2203-W-9825 | 2    | .452 in./11.48 mm Spacer |  |
| 3    | 2203-X-9826 | 2    | .453 in./11.50 mm Spacer |  |
| 4    | 2203-Y-9827 | 2    | .454 in./11.53 mm Spacer |  |
| 5    | 2203-Z-9828 | 2    | .455 in./11.55 mm Spacer |  |
| 6    | 2203-A-9829 | 2    | .459 in./11.65 mm Spacer |  |
| 7    | 2203-B-9830 | 2    | .463 in./11.75 mm Spacer |  |
| 8    | 2203-C-9831 | 2    | .467 in./11.85 mm Spacer |  |
| 9    | 2203-D-9832 | 2    | .470 in./11.95 mm Spacer |  |
| 10   | 2203-E-9833 | 2    | .474 in./12.05 mm Spacer |  |
| 11   | 2203-F-9834 | 2    | .478 in./12.15 mm Spacer |  |
| 12   | 2203-G-9835 | 2    | .482 in./12.25 mm Spacer |  |
| 13   | 2203-H-9836 | 2    | .483 in./12.28 mm Spacer |  |
| 14   | 2203-J-9838 | 2    | .484 in./12.30 mm Spacer |  |
| 15   | 2203-K-9839 | 2    | .485 in./12.33 mm Spacer |  |
| 16   | 2203-L-9840 | 2    | .486 in./12.35 mm Spacer |  |

## KIT 2406

| ITEM | PART NUMBER | QTY. | DESCRIPTION       | REMARKS   |
|------|-------------|------|-------------------|---|
| 1    | 3196-F-32   | 1    | Air Cylinder tube | Bolt-on shifter.<br>RD-23-160, RD-23-164, RD-26-160, RP-23-160, RP-23-164, RP-26-160, RS-23-160, RS-23-161, RS-25-160, RS-26-160<br>3200-C-1511, 3200-Z-1560, 3200-P-1628, 3200-V-1660, 3200-K-1701, 3200-R-1708, 3200-V-1712, 3200-W-1713, 3200-Y-1819, 3200-C-1823, 3200-E-1825 |
| 2    | 2230-N-170  | 1    | Piston            |   |
| 3    | 5-X-1153    | 1    | O-Ring            |   |
| 4    | 2208-H-944  | 1    | Gasket            |   |
| 5    | 41-X-1333   | 1    | Capscrew          |   |
| 6    | 41-X-1364   | 4    | Capscrew          |   |
| 7    | MWA-506     | 4    | Washer            |   |
| 8    | 42-X-1027   | 1    | Washer            |   |

## KIT 2414

| ITEM | PART NUMBER | QTY. | DESCRIPTION          | REMARKS  |
|------|-------------|------|----------------------|--|
| 1    | 3266-F-1020 | 1    | Cover                | Services carriers with main diff. lock, prior to 11/93.<br>RS-23-160, RS-23-161, RS-25-160, RS-26-160<br>3200-C-1511, 3200-P-1628, 3200-V-1660 |
| 2    | MWA-506     | 4    | Washer               |  |
| 3    | 2208-L-1000 | 1    | Gasket               |  |
| 4    | MS-210016-1 | 1    | Capscrew             |  |
| 5    | 41-X-1364   | 4    | Capscrew             |  |
| 6    | 2208-H-944  | 1    | Gasket               |  |
| 7    | 3196-F-32   | 1    | Air Cylinder tube    |  |
| 8    | 5-X-1153    | 1    | O-Ring               |  |
| 9    | 2230-N-170  | 1    | Piston               |  |
| 10   | 42-X-1027   | 1    | Washer               |  |
| 11   | 2244-Y-51   | 1    | Shift Shaft          |  |
| 12   | 43-X-1006   | 1    | Shift Shaft Pin      |  |
| 13   | 2258-L-714  | 1    | Spring               |  |
| 14   | 43-X-1007   | 2    | Shift Fork Pin       |  |
| 15   | 41-X-1333   | 1    | Capscrew             |  |
| 16   | 3296-Y-1169 | 1    | Shift Fork           |  |
| 17   | 3107-F-1020 | 1    | Shift Collar         |  |
| 18   | KIT 4429    | 1    | DCDL Switch Kit      |  |
| 19   | 1227-P-1056 | 1    | Sensor Adjusting Nut |  |

## KIT 2424

| ITEM | PART NUMBER | QTY. | DESCRIPTION                                 | REMARKS   |
|------|-------------|------|---|---|
| 1    | 2234-T-1190 | 1    | Differential Side Gear, Finished            | I.A.D. nest with spider<br>RD-23-160, RD-23-164, RD-26-160, RP-23-160, RP-23-164, RP-26-160<br>3200-J-1648, 3200-J-1908, 3200-K-1701, 3200-K-1857, 3200-K-1909, 3200-L-1858, 3200-M-1703, 3200-P-1628, 3200-Q-1837, 3200-V-1894, 3200-W-1713, 3200-W-1895, 3200-X-1818, 3200-Y-1819, 3200-Z-1820, 3200-J-2116, 3200-K-2117, 3200-L-2118 |
| 2    | 3892-T-4934 | 1    | Integral Gear (Helical, Forward, Side Gear) |   |
| 3    | 3278-N-300  | 1    | Differential Spider                         |   |
| 4    | 2233-K-245  | 4    | Differential Pinion, Finished               |   |
| 5    | 1229-Q-2929 | 4    | Pinion Thrust Washer                        |   |
| 6    | 1229-S-4985 | 1    | Thrust Washer                               |   |
| 7    | 2297-S-5349 | 1    | Snap Ring                                   |   |

# SERVICE KITS

## KIT 2426

| ITEM | PART NUMBER | QTY. | DESCRIPTION | REMARKS   |
|------|-------------|------|-------------|---|
| 1    | 1229-U-1503 | 12   | Washer      | Gear to case bolt kit (16.5 mm bolts after 4-88)<br>RD-23-160, RD-23-164, RD-26-160, RP-23-160, RP-23-164,<br>RP-26-160, RR-23-160, RR-23-164, RR-26-160, RS-23-160,<br>RS-23-161, RS-25-160, RS-26-160 |
| 2    | 40-X-1182   | 12   | Lock Nut    |   |
| 3    | 41-X-1276   | 12   | Capscrew    |   |

## KIT 2429

| ITEM | PART NUMBER | QTY. | DESCRIPTION            | REMARKS   |
|------|-------------|------|------------------------|---|
| 1    | 2203-K-9241 | 1    | Shim - .076mm/.003 in. | RD-23-160, RD-23-164, RD-26-160, RP-23-160, RP-23-164,<br>RP-26-160 |
| 2    | 2203-L-9242 | 1    | Shim - .127mm/.005 in. |   |
| 3    | 2203-M-9243 | 4    | Shim - .254mm/.010 in. |   |
| 4    | 2203-F-2788 | 1    | Shim - .076mm/.003 in. |   |
| 5    | 2203-G-2789 | 1    | Shim - .127mm/.005 in. |   |
| 6    | 2203-H-2790 | 4    | Shim - .254mm/.010 in. |   |

## KIT 2483

| ITEM | PART NUMBER | QTY. | DESCRIPTION                                 | REMARKS   |
|------|-------------|------|---|---|
| 1    | 3892-T-4934 | 1    | Integral Gear (Helical, Forward, Side Gear) | RD-23-160, RD-23-164, RD-26-160, RP-23-160, RP-23-164,<br>RP-26-160 |
| 2    | 3892-U-4909 | 1    | Helical Gear                                |   |

## KIT 2489

| ITEM | PART NUMBER | QTY. | DESCRIPTION                                 | REMARKS  |
|------|-------------|------|---|--|
| 1    | 2234-T-1190 | 1    | Differential Side Gear, Finished            | I.A.D. nest less spider  |
| 2    | 3892-T-4934 | 1    | Integral Gear (Helical, Forward, Side Gear) | RD-23-160, RD-23-164, RD-26-160, RP-23-160, RP-23-164,<br>RP-26-160  |
| 3    | 2233-K-245  | 4    | Differential Pinion, Finished               |  |
| 4    | 1229-Q-2929 | 4    | Pinion Thrust Washer                        | 3200-J-1648, 3200-J-1908, 3200-K-1701, 3200-K-1857,<br>3200-K-1909, 3200-L-1858, 3200-M-1703, 3200-P-1628,<br>3200-Q-1837, 3200-V-1894, 3200-W-1713, 3200-W-1895,<br>3200-X-1818, 3200-Y-1819, 3200-Z-1820, 3200-J-2116,<br>3200-K-2117, 3200-L-2118 |
| 5    | 1229-S-4985 | 1    | Thrust Washer                               |  |

## KIT 2575

| ITEM | PART NUMBER  | QTY. | DESCRIPTION         | REMARKS  |
|------|--------------|------|---------------------|--|
| 1    | 2234-C-1069N | 2    | Side Gear           | Coach Quality main diff. kit with spider.<br>RS-23-160, RS-23-161, RS-25-160 |
| 2    | 2233-M-1001  | 4    | Differential Pinion |  |
| 3    | 3278-W-335   | 1    | Spider              |  |
| 4    | 1229-K-3001  | 4    | Thrust Washer       |  |
| 5    | 1229-L-3002  | 2    | Thrust Washer       |  |

## KIT 2614

| ITEM | PART NUMBER | QTY. | DESCRIPTION     | REMARKS  |
|------|-------------|------|-----------------|--|
| 1    | 2230-N-170  | 1    | Piston          | Main diff. lock piston kit.<br>RD-23-160, RD-23-164, RD-26-160, RP-23-160, RP-23-164,<br>RP-26-160, RS-23-160, RS-23-161, RS-25-160, RS-26-160<br>3200-C-1511, 3200-Z-1560, 3200-P-1628, 3200-V-1660,<br>3200-K-1701, 3200-R-1708, 3200-V-1712, 3200-W-1713,<br>3200-Y-1819, 3200-Z-1820, 3200-C-1823, 3200-E-1825 |
| 2    | 5-X-1153    | 1    | O-Ring          |  |
| 3    | 41-X-1333   | 1    | Capscrew        |  |
| 4    | 41-X-1359   | 4    | Shift Unit Bolt |  |
| 5    | MWA-506     | 4    | Washer          |  |



# SERVICE KITS

## KIT 2615

| ITEM | PART NUMBER | QTY. | DESCRIPTION          | REMARKS   |
|------|-------------|------|----------------------|---|
| 1    | 3296-Y-1169 | 1    | Shift Fork           | Main diff. lock actuator kit.   |
| 2    | 3107-B-1094 | 1    | Clutch Collar        | RP-23-160, RP-23-164, RP-26-160, RS-23-160, RS-23-161, RS-25-160, RS-26-160<br>3200-K-1701, 3200-R-1708, 3200-V-1712, 3200-W-1713, 3200-Y-1819, 3200-Z-1820, 3200-C-1823, 3200-E-1825 |
| 3    | 43-X-1007   | 2    | Shift Fork Pin       |   |
| 4    | 2244-L-1026 | 1    | Shift Shaft          |   |
| 5    | 43-X-1006   | 1    | Shift Shaft Pin      |   |
| 6    | 2258-L-714  | 1    | Spring               |   |
| 7    | 3196-F-32   | 1    | Air Cylinder tube    |   |
| 8    | 2230-N-170  | 1    | Piston               |   |
| 9    | 5-X-1153    | 1    | O-Ring               |   |
| 10   | 2208-H-944  | 1    | Gasket               |   |
| 11   | 3266-F-1020 | 1    | Cover                |   |
| 12   | MWA-506     | 4    | Washer               |   |
| 13   | 41-X-1364   | 4    | Capscrew             |   |
| 14   | 2208-L-1000 | 1    | Gasket               |   |
| 15   | MS-210016-1 | 1    | Capscrew             |   |
| 16   | 41-X-1333   | 1    | Capscrew             |   |
| 17   | KIT 4429    | 1    | DCDL Switch Kit      |   |
| 18   | 1227-P-1056 | 1    | Sensor Adjusting Nut |   |

## KIT 2616

| ITEM | PART NUMBER | QTY. | DESCRIPTION            | REMARKS  |
|------|-------------|------|------------------------|--|
| 1    | 41-X-1080   | 4    | Capscrew               | Carrier and cap update kit<br>RP-23-160, RP-23-164, RP-26-160<br>3200-K-1701 |
| 2    | 41-X-1364   | 4    | Capscrew               |  |
| 3    | MWA-506     | 4    | Washer                 |  |
| 4    | KIT 2825    | 1    | Shift Kit              |  |
| 5    | KIT 2763    | 1    | Carrier & Cap Assembly |  |

## KIT 2618

| ITEM | PART NUMBER     | QTY. | DESCRIPTION            | REMARKS  |
|------|-----------------|------|------------------------|--|
| 1    | A2-3200-J-2116S | 1    | Carrier & Cap Assembly | Carrier and cap update kit<br>RD-23-160, RD-23-164, RD-26-160<br>3200-M-1703 |
| 2    | KIT 2825        | 1    | Shift Kit              |  |

## KIT 2624

| ITEM | PART NUMBER    | QTY. | DESCRIPTION       | REMARKS   |
|------|----------------|------|-------------------|---|
| 1    | A1-3297-S-1605 | 1    | Input Shaft       | Pump update kit<br>RD-23-160, RD-23-164, RD-26-160<br>3200-P-1628 |
| 2    | A-3303-P-1030  | 1    | Oil Pump Assembly |   |

# SERVICE KITS

## KIT 2637

| ITEM | PART NUMBER | QTY. | DESCRIPTION | REMARKS  |
|------|-------------|------|-------------|--|
| 1    | 40-X-1237   | 1    | Input Nut   | M39 x 1.5 nut thread. Front input, rear input.         |
| 2    | 1229-T-1736 | 1    | Washer      | RD160, RD164, RP160, RP164, RR160, RR164, RS160, RS161 |

## KIT 2638

| ITEM | PART NUMBER | QTY. | DESCRIPTION | REMARKS  |
|------|-------------|------|-------------|--|
| 1    | 40-X-1233   | 1    | Lock Nut    | M45 x 1.5 nut thread. Front input.                     |
| 2    | 1229-W-4521 | 1    | Washer      | RD160, RD164, RP160, RP164, RR160, RR164, RS160, RS161 |

## KIT 2640

| ITEM | PART NUMBER    | QTY. | DESCRIPTION                 | REMARKS  |
|------|----------------|------|-----------------------------|--|
| 1    | KIT 2763       | 1    | Carrier & Cap Assembly      | Carrier and cap update kit (with diff case assembly, fast ratios) for diff. lock<br>RD-23-160, RD-23-164, RD-26-160<br>3200-P-1628 |
| 2    | A2-3261-Q-1057 | 1    | IAD Shift Cylinder Assembly |  |
| 3    | 3107-B-1094    | 1    | Clutch Collar               |  |
| 4    | 41-X-1364      | 4    | Capscrew                    |  |
| 5    | MWA-506        | 4    | Washer                      |  |
| 6    | 2214-G-1125    | 1    | Adjusting Ring              |  |
| 7    | 2214-J-1128    | 1    | Adjusting Ring              |  |
| 8    | 592A           | 1    | Bearing Cup                 |  |
| 9    | 594A           | 1    | Differential Bearing Cone   |  |
| 10   | 52618          | 1    | Bearing Cup                 |  |
| 11   | 52400          | 1    | Differential Bearing Cone   |  |
| 12   | A2-3235-C-2109 | 1    | Unloaded Differential Case  |  |

## KIT 2640A

| ITEM | PART NUMBER    | QTY. | DESCRIPTION                 | REMARKS   |
|------|----------------|------|-----------------------------|---|
| 1    | KIT 2763       | 1    | Carrier & Cap Assembly      | Carrier and cap update kit (with diff case assembly, mid-range ratios) for diff. lock<br>RD-23-160, RD-23-164, RD-26-160<br>3200-P-1628 |
| 2    | A2-3261-Q-1057 | 1    | IAD Shift Cylinder Assembly |   |
| 3    | 3107-B-1094    | 1    | Clutch Collar               |   |
| 4    | 41-X-1364      | 4    | Capscrew                    |   |
| 5    | MWA-506        | 4    | Washer                      |   |
| 6    | 2214-G-1125    | 1    | Adjusting Ring              |   |
| 7    | 2214-J-1128    | 1    | Adjusting Ring              |   |
| 8    | 592A           | 1    | Bearing Cup                 |   |
| 9    | 594A           | 1    | Differential Bearing Cone   |   |
| 10   | 52618          | 1    | Bearing Cup                 |   |
| 11   | 52400          | 1    | Differential Bearing Cone   |   |
| 12   | A2-3235-E-2111 | 1    | Unloaded Differential Case  |   |

## KIT 2640B

| ITEM | PART NUMBER    | QTY. | DESCRIPTION                 | REMARKS  |
|------|----------------|------|-----------------------------|--|
| 1    | KIT 2763       | 1    | Carrier & Cap Assembly      | Carrier and cap update kit (with diff case assembly, standard ratios) for diff. lock<br>RD-23-160, RD-23-164, RD-26-160<br>3200-P-1628 |
| 2    | A2-3261-Q-1057 | 1    | IAD Shift Cylinder Assembly |  |
| 3    | 3107-B-1094    | 1    | Clutch Collar               |  |
| 4    | 41-X-1364      | 4    | Capscrew                    |  |
| 5    | MWA-506        | 4    | Washer                      |  |
| 6    | 2214-G-1125    | 1    | Adjusting Ring              |  |
| 7    | 2214-J-1128    | 1    | Adjusting Ring              |  |
| 8    | 592A           | 1    | Bearing Cup                 |  |
| 9    | 594A           | 1    | Differential Bearing Cone   |  |
| 10   | 52618          | 1    | Bearing Cup                 |  |
| 11   | 52400          | 1    | Differential Bearing Cone   |  |
| 12   | A2-3235-G-2113 | 1    | Unloaded Differential Case  |  |

# SERVICE KITS

## KIT 2641

| ITEM | PART NUMBER    | QTY. | DESCRIPTION                 | REMARKS   |
|------|----------------|------|-----------------------------|---|
| 1    | KIT 2766       | 1    | Carrier & Cap Assembly      | Carrier and cap update kit (with diff case assembly, fast ratios) less diff. lock<br>RP-23-160, RP-23-164, RP-26-160<br>3200-P-1628 |
| 2    | A2-3261-Q-1057 | 1    | IAD Shift Cylinder Assembly |   |
| 3    | 41-X-1080      | 4    | Capscrew                    |   |
| 4    | MWA-506        | 4    | Washer                      |   |
| 5    | 2214-G-1125    | 1    | Adjusting Ring              |   |
| 6    | 2214-J-1128    | 1    | Adjusting Ring              |   |
| 7    | 594A           | 1    | Differential Bearing Cone   |   |
| 8    | 592A           | 1    | Bearing Cup                 |   |
| 9    | 52400          | 1    | Differential Bearing Cone   |   |
| 10   | 52618          | 1    | Bearing Cup                 |   |
| 11   | A5-3235-C-2109 | 1    | Unloaded Differential Case  |   |

## KIT 2641A

| ITEM | PART NUMBER    | QTY. | DESCRIPTION                 | REMARKS  |
|------|----------------|------|-----------------------------|--|
| 1    | KIT 2766       | 1    | Carrier & Cap Assembly      | Carrier and cap update kit (with diff case assembly, mid-range ratios) less diff. lock<br>RP-23-160, RP-23-164, RP-26-160<br>3200-P-1628 |
| 2    | A2-3261-Q-1057 | 1    | IAD Shift Cylinder Assembly |  |
| 3    | 41-X-1080      | 4    | Capscrew                    |  |
| 4    | MWA-506        | 4    | Washer                      |  |
| 5    | 2214-G-1125    | 1    | Adjusting Ring              |  |
| 6    | 2214-J-1128    | 1    | Adjusting Ring              |  |
| 7    | 594A           | 1    | Differential Bearing Cone   |  |
| 8    | 592A           | 1    | Bearing Cup                 |  |
| 9    | 52400          | 1    | Differential Bearing Cone   |  |
| 10   | 52618          | 1    | Bearing Cup                 |  |
| 11   | A5-3235-E-2111 | 1    | Unloaded Differential Case  |  |

## KIT 2641B

| ITEM | PART NUMBER    | QTY. | DESCRIPTION                 | REMARKS   |
|------|----------------|------|-----------------------------|---|
| 1    | KIT 2766       | 1    | Carrier & Cap Assembly      | Carrier and cap update kit (with diff case assembly, standard ratios) less diff. lock<br>RP-23-160, RP-23-164, RP-26-160<br>3200-P-1628 |
| 2    | A2-3261-Q-1057 | 1    | IAD Shift Cylinder Assembly |   |
| 3    | 41-X-1080      | 4    | Capscrew                    |   |
| 4    | MWA-506        | 4    | Washer                      |   |
| 5    | 2214-G-1125    | 1    | Adjusting Ring              |   |
| 6    | 2214-J-1128    | 1    | Adjusting Ring              |   |
| 7    | 594A           | 1    | Differential Bearing Cone   |   |
| 8    | 592A           | 1    | Bearing Cup                 |   |
| 9    | 52400          | 1    | Differential Bearing Cone   |   |
| 10   | 52618          | 1    | Bearing Cup                 |   |
| 11   | A5-3235-G-2113 | 1    | Unloaded Differential Case  |   |

## KIT 2642

| ITEM | PART NUMBER    | QTY. | DESCRIPTION                | REMARKS   |
|------|----------------|------|----------------------------|---|
| 1    | A2-3200-P-1706 | 1    | Carrier & Cap Assembly     | Carrier and cap update kit (with diff case assembly, fast ratios) less diff. lock<br>RS-23-160, RS-23-161, RS-25-160, RS-26-160<br>3200-T-1658, 3200-Z-1560 |
| 2    | 2214-G-1125    | 2    | Adjusting Ring             |   |
| 3    | 592A           | 2    | Bearing Cup                |   |
| 4    | 594A           | 2    | Differential Bearing Cone  |   |
| 5    | 1228-B-1042    | 1    | Spigot Bearing             |   |
| 6    | A-3235-C-2109  | 1    | Unloaded Differential Case |   |

## KIT 2642A

| ITEM | PART NUMBER    | QTY. | DESCRIPTION                | REMARKS  |
|------|----------------|------|----------------------------|--|
| 1    | A2-3200-P-1706 | 1    | Carrier & Cap Assembly     | Carrier and cap update kit (with diff case assembly, mid-range ratios) less diff. lock<br>RS-23-160, RS-23-161, RS-25-160, RS-26-160<br>3200-T-1658, 3200-Z-1560 |
| 2    | 2214-G-1125    | 2    | Adjusting Ring             |  |
| 3    | 592A           | 2    | Bearing Cup                |  |
| 4    | 594A           | 2    | Differential Bearing Cone  |  |
| 5    | 1228-B-1042    | 1    | Spigot Bearing             |  |
| 6    | A-3235-E-2111  | 1    | Unloaded Differential Case |  |

# SERVICE KITS

## KIT 2642B

| ITEM | PART NUMBER    | QTY. | DESCRIPTION                | REMARKS   |
|------|----------------|------|----------------------------|---|
| 1    | A2-3200-P-1706 | 1    | Carrier & Cap Assembly     | Carrier and cap update kit (with diff case assembly, standard ratios) less diff. lock<br>RS-23-160, RS-23-161, RS-25-160, RS-26-160<br>3200-T-1658, 3200-Z-1560 |
| 2    | A-3235-G-2113  | 1    | Unloaded Differential Case |   |
| 3    | 594A           | 2    | Differential Bearing Cone  |   |
| 4    | 592A           | 2    | Bearing Cup                |   |
| 5    | 2214-G-1125    | 2    | Adjusting Ring             |   |
| 6    | 1228-B-1042    | 1    | Spigot Bearing             |   |

## KIT 2643

| ITEM | PART NUMBER    | QTY. | DESCRIPTION                | REMARKS   |
|------|----------------|------|----------------------------|---|
| 1    | KIT 2762       | 1    | Carrier & Cap Assembly     | Carrier and cap update kit (with diff case assembly, fast ratios) for diff. lock.<br>RS-23-160, RS-23-161, RS-25-160, RS-26-160<br>3200-V-1660, 3200-Z-1560 |
| 2    | 3107-B-1094    | 1    | Clutch Collar              |   |
| 3    | A2-3235-C-2109 | 1    | Unloaded Differential Case |   |
| 4    | 2214-G-1125    | 1    | Adjusting Ring             |   |
| 5    | 2214-J-1128    | 1    | Adjusting Ring             |   |
| 6    | 1228-B-1042    | 1    | Spigot Bearing             |   |
| 7    | 41-X-1364      | 4    | Capscrew                   |   |
| 8    | 594A           | 1    | Differential Bearing Cone  |   |
| 9    | 592A           | 1    | Bearing Cup                |   |
| 10   | 52400          | 1    | Differential Bearing Cone  |   |
| 11   | 52618          | 1    | Bearing Cup                |   |
| 12   | MWA-506        | 4    | Washer                     |   |

## KIT 2643A

| ITEM | PART NUMBER    | QTY. | DESCRIPTION                | REMARKS   |
|------|----------------|------|----------------------------|---|
| 1    | KIT 2762       | 1    | Carrier & Cap Assembly     | Carrier and cap update kit (with diff case assembly, mid-range ratios) for diff. lock<br>RS-23-160, RS-23-161, RS-25-160, RS-26-160<br>3200-V-1660, 3200-Z-1560 |
| 2    | A2-3235-E-2111 | 1    | Unloaded Differential Case |   |
| 3    | 3107-B-1094    | 1    | Clutch Collar              |   |
| 4    | 2214-J-1128    | 1    | Adjusting Ring             |   |
| 5    | 2214-G-1125    | 1    | Adjusting Ring             |   |
| 6    | 1228-B-1042    | 1    | Spigot Bearing             |   |
| 7    | 594A           | 1    | Differential Bearing Cone  |   |
| 8    | 592A           | 1    | Bearing Cup                |   |
| 9    | 52400          | 1    | Differential Bearing Cone  |   |
| 10   | 52618          | 1    | Bearing Cup                |   |
| 11   | 41-X-1364      | 4    | Capscrew                   |   |
| 12   | MWA-506        | 4    | Washer                     |   |

## KIT 2643B

| ITEM | PART NUMBER    | QTY. | DESCRIPTION                | REMARKS  |
|------|----------------|------|----------------------------|--|
| 1    | KIT 2762       | 1    | Carrier & Cap Assembly     | Carrier and cap update kit (with diff case assembly, standard ratios) for diff. lock<br>RS-23-160, RS-23-161, RS-25-160, RS-26-160<br>3200-V-1660, 3200-Z-1560 |
| 2    | A2-3235-G-2113 | 1    | Unloaded Differential Case |  |
| 3    | 3107-B-1094    | 1    | Clutch Collar              |  |
| 4    | 2214-J-1128    | 1    | Adjusting Ring             |  |
| 5    | 2214-G-1125    | 1    | Adjusting Ring             |  |
| 6    | 1228-B-1042    | 1    | Spigot Bearing             |  |
| 7    | 594A           | 1    | Differential Bearing Cone  |  |
| 8    | 592A           | 1    | Bearing Cup                |  |
| 9    | 52400          | 1    | Differential Bearing Cone  |  |
| 10   | 52618          | 1    | Bearing Cup                |  |
| 11   | 41-X-1364      | 4    | Capscrew                   |  |
| 12   | MWA-506        | 4    | Washer                     |  |

## KIT 2644

| ITEM | PART NUMBER    | QTY. | DESCRIPTION                 | REMARKS  |
|------|----------------|------|-----------------------------|--|
| 1    | A2-3200-X-1818 | 1    | Carrier & Cap Assembly      | Carrier and cap update kit (with diff case assembly, fast ratios) less diff. lock. Conversion kit from bolt-on to screw-in I.A.D. shifter.<br>RD-23-160, RD-23-164, RD-26-160<br>3200-J-1648 |
| 2    | A-3235-C-2109  | 1    | Unloaded Differential Case  |  |
| 3    | A2-3261-Q-1057 | 1    | IAD Shift Cylinder Assembly |  |
| 4    | 594A           | 2    | Differential Bearing Cone   |  |
| 5    | 592A           | 2    | Bearing Cup                 |  |
| 6    | 2214-G-1125    | 2    | Adjusting Ring              |  |

# SERVICE KITS

## KIT 2644A

| ITEM | PART NUMBER    | QTY. | DESCRIPTION                 | REMARKS   |
|------|----------------|------|-----------------------------|---|
| 1    | A2-3200-X-1818 | 1    | Carrier & Cap Assembly      | Carrier and cap update kit (with diff case assembly, mid-range ratios) less diff. lock. Conversion kit from bolt-on to screw-in I.A.D. shifter.<br>RD-23-160, RD-23-164, RD-26-160<br>3200-J-1648 |
| 2    | A-3235-E-2111  | 1    | Unloaded Differential Case  |   |
| 3    | A2-3261-Q-1057 | 1    | IAD Shift Cylinder Assembly |   |
| 4    | 594A           | 2    | Differential Bearing Cone   |   |
| 5    | 592A           | 2    | Bearing Cup                 |   |
| 6    | 2214-G-1125    | 2    | Adjusting Ring              |   |

## KIT 2644B

| ITEM | PART NUMBER    | QTY. | DESCRIPTION                 | REMARKS  |
|------|----------------|------|-----------------------------|--|
| 1    | A2-3200-X-1818 | 1    | Carrier & Cap Assembly      | Carrier and cap update kit (with diff case assembly, standard ratios) less diff. lock. Conversion kit from bolt-on to screw-in I.A.D. shifter.<br>RD-23-160, RD-23-164, RD-26-160<br>3200-J-1648 |
| 2    | A-3235-G-2113  | 1    | Unloaded Differential Case  |  |
| 3    | A2-3261-Q-1057 | 1    | IAD Shift Cylinder Assembly |  |
| 4    | 592A           | 2    | Bearing Cup                 |  |
| 5    | 594A           | 2    | Differential Bearing Cone   |  |
| 6    | 2214-G-1125    | 2    | Adjusting Ring              |  |

## KIT 2657

| ITEM | PART NUMBER    | QTY. | DESCRIPTION                | REMARKS  |
|------|----------------|------|----------------------------|--|
| 1    | KIT 2634       | 1    | Carrier & Cap Update Kit   | Carrier and cap update kit (with diff case assembly, fast ratios) less diff. lock<br>RS-23-160, RS-23-161, RS-25-160, RS-26-160<br>3200-C-1511 |
| 2    | A5-3235-C-2109 | 1    | Unloaded Differential Case |  |
| 3    | 594A           | 1    | Differential Bearing Cone  |  |
| 4    | 592A           | 1    | Bearing Cup                |  |
| 5    | 52618          | 1    | Bearing Cup                |  |
| 6    | 52400          | 1    | Differential Bearing Cone  |  |
| 7    | 2214-J-1128    | 1    | Adjusting Ring             |  |
| 8    | 2214-G-1125    | 1    | Adjusting Ring             |  |
| 9    | 1228-B-1042    | 1    | Spigot Bearing             |  |

## KIT 2657A

| ITEM | PART NUMBER    | QTY. | DESCRIPTION                | REMARKS   |
|------|----------------|------|----------------------------|---|
| 1    | KIT 2634       | 1    | Carrier & Cap Update Kit   | Carrier and cap update kit (with diff case assembly, mid-range ratios) less diff. lock<br>RS-23-160, RS-23-161, RS-25-160, RS-26-160<br>3200-C-1511 |
| 2    | A5-3235-E-2111 | 1    | Unloaded Differential Case |   |
| 3    | 2214-G-1125    | 1    | Adjusting Ring             |   |
| 4    | 2214-J-1128    | 1    | Adjusting Ring             |   |
| 5    | 594A           | 1    | Differential Bearing Cone  |   |
| 6    | 592A           | 1    | Bearing Cup                |   |
| 7    | 52400          | 1    | Differential Bearing Cone  |   |
| 8    | 52618          | 1    | Bearing Cup                |   |
| 9    | 1228-B-1042    | 1    | Spigot Bearing             |   |

## KIT 2657B

| ITEM | PART NUMBER    | QTY. | DESCRIPTION                | REMARKS  |
|------|----------------|------|----------------------------|--|
| 1    | KIT 2634       | 1    | Carrier & Cap Update Kit   | Carrier and cap update kit (with diff case assembly, standard ratios) less diff. lock<br>RS-23-160, RS-23-161, RS-25-160, RS-26-160<br>3200-C-1511 |
| 2    | A5-3235-G-2113 | 1    | Unloaded Differential Case |  |
| 3    | 2214-G-1125    | 1    | Adjusting Ring             |  |
| 4    | 2214-J-1128    | 1    | Adjusting Ring             |  |
| 5    | 594A           | 1    | Differential Bearing Cone  |  |
| 6    | 592A           | 1    | Bearing Cup                |  |
| 7    | 52400          | 1    | Differential Bearing Cone  |  |
| 8    | 52618          | 1    | Bearing Cup                |  |
| 9    | 1228-B-1042    | 1    | Spigot Bearing             |  |

# SERVICE KITS

## KIT 2658

| ITEM | PART NUMBER    | QTY. | DESCRIPTION                | REMARKS   |
|------|----------------|------|----------------------------|---|
| 1    | KIT 2634       | 1    | Carrier & Cap Update Kit   | Carrier and cap update kit (with diff case assembly, fast ratios) for diff. lock<br>RS-23-160, RS-23-161, RS-25-160, RS-26-160<br>3200-C-1511 |
| 2    | A2-3235-C-2109 | 1    | Unloaded Differential Case |   |
| 3    | 3107-B-1094    | 1    | Clutch Collar              |   |
| 4    | 2214-J-1128    | 1    | Adjusting Ring             |   |
| 5    | 2214-G-1125    | 1    | Adjusting Ring             |   |
| 6    | 1228-B-1042    | 1    | Spigot Bearing             |   |
| 7    | 594A           | 1    | Differential Bearing Cone  |   |
| 8    | 592A           | 1    | Bearing Cup                |   |
| 9    | 52400          | 1    | Differential Bearing Cone  |   |
| 10   | 52618          | 1    | Bearing Cup                |   |

## KIT 2658A

| ITEM | PART NUMBER    | QTY. | DESCRIPTION                | REMARKS  |
|------|----------------|------|----------------------------|--|
| 1    | KIT 2634       | 1    | Carrier & Cap Update Kit   | Carrier and cap update kit (with diff case assembly, mid-range ratios) for diff. lock<br>RS-23-160, RS-23-161, RS-25-160, RS-26-160<br>3200-C-1511 |
| 2    | A2-3235-E-2111 | 1    | Unloaded Differential Case |  |
| 3    | 3107-B-1094    | 1    | Clutch Collar              |  |
| 4    | 2214-J-1128    | 1    | Adjusting Ring             |  |
| 5    | 2214-G-1125    | 1    | Adjusting Ring             |  |
| 6    | 1228-B-1042    | 1    | Spigot Bearing             |  |
| 7    | 594A           | 1    | Differential Bearing Cone  |  |
| 8    | 592A           | 1    | Bearing Cup                |  |
| 9    | 52400          | 1    | Differential Bearing Cone  |  |
| 10   | 52618          | 1    | Bearing Cup                |  |

## KIT 2658B

| ITEM | PART NUMBER    | QTY. | DESCRIPTION                | REMARKS   |
|------|----------------|------|----------------------------|---|
| 1    | KIT 2634       | 1    | Carrier & Cap Update Kit   | Carrier and cap update kit (with diff case assembly, standard ratios) for diff. lock<br>RS-23-160, RS-23-161, RS-25-160, RS-26-160<br>3200-C-1511 |
| 2    | A2-3235-G-2113 | 1    | Unloaded Differential Case |   |
| 3    | 3107-B-1094    | 1    | Clutch Collar              |   |
| 4    | 2214-J-1128    | 1    | Adjusting Ring             |   |
| 5    | 2214-G-1125    | 1    | Adjusting Ring             |   |
| 6    | 1228-B-1042    | 1    | Spigot Bearing             |   |
| 7    | 594A           | 1    | Differential Bearing Cone  |   |
| 8    | 592A           | 1    | Bearing Cup                |   |
| 9    | 52400          | 1    | Differential Bearing Cone  |   |
| 10   | 52618          | 1    | Bearing Cup                |   |

## KIT 2659

| ITEM | PART NUMBER | QTY. | DESCRIPTION            | REMARKS  |
|------|-------------|------|------------------------|--|
| 1    | KIT 2762    | 1    | Carrier & Cap Assembly | Carrier and cap update kit (with diff. lock)<br>RS-23-160, RS-23-161, RS-25-160, RS-26-160<br>3200-C-1823, 3200-D-1928, 3200-R-1708, 3200-T-1892 |
| 2    | 41-X-1364   | 4    | Capscrew               |  |
| 3    | MWA-506     | 4    | Washer                 |  |

## KIT 2691

| ITEM | PART NUMBER   | QTY. | DESCRIPTION         | REMARKS   |
|------|---------------|------|---------------------|---|
| 1    | A-3261-A-1067 | 1    | DCDL Shift Cylinder | Main diff. lock, screw-in shift, Services all new style screw in type main differential lock carriers<br>RD-23-160, RD-23-164, RD-26-160, RP-23-160, RP-23-164, RP-26-160<br>3200-T-1892, 3200-V-1894 |
| 2    | 2244-Z-1222   | 1    | Push Rod            |   |
| 3    | 5-X-521       | 1    | O-Ring              |   |
| 4    | 41-X-1368     | 1    | Caging Bolt         |   |

# SERVICE KITS

## KIT 2698

| ITEM | PART NUMBER   | QTY. | DESCRIPTION         | REMARKS  |
|------|---------------|------|---------------------|--|
| 1    | 3296-B-1172   | 1    | Shift Fork          | Main diff. lock kit.                                   |
| 2    | 3107-B-1094   | 1    | Clutch Collar       | RD-23-160, RD-23-164, RD-26-160, RP-23-160, RP-23-164, |
| 3    | 2244-Z-1222   | 1    | Push Rod            | RP-26-160, RR-23-160, RR-23-164, RR-26-160, RS-23-160, |
| 4    | 2258-N-1262   | 1    | Spring              | RS-23-161, RS-25-160, RS-26-160                        |
| 5    | A-3261-A-1067 | 1    | DCDL Shift Cylinder | 3200-T-1892, 3200-V-1894, 3200-W-1895, 3200-Y-1897,    |
| 6    | 2230-T-1190   | 1    | Piston              | 3200-J-1908, 3200-K-1909, 3200-D-1928, 3200-E-1929,    |
| 7    | 41-X-1368     | 1    | Caging Bolt         | 3200-K-2117, 3200-L-2118                               |
| 8    | 5-X-521       | 1    | O-Ring              |  |
| 9    | KIT 4429      | 1    | DCDL Switch Kit     |  |

## KIT 2750

| ITEM | PART NUMBER   | QTY. | DESCRIPTION         | REMARKS  |
|------|---------------|------|---------------------|--|
| 1    | 2244-Z-1222   | 1    | Push Rod            | Screw-in shifter.                                      |
| 2    | 2258-N-1262   | 1    | Spring              | RD-23-160, RD-23-164, RD-26-160, RP-23-160, RP-23-164, |
| 3    | A-3261-A-1067 | 1    | DCDL Shift Cylinder | RP-26-160  |
| 4    | 41-X-1368     | 1    | Caging Bolt         | 3200-T-1892, 3200-V-1894, 3200-K-2117                  |
| 5    | 5-X-521       | 1    | O-Ring              |  |

## KIT 2762

| ITEM | PART NUMBER    | QTY. | DESCRIPTION            | REMARKS  |
|------|----------------|------|------------------------|--|
| 1    | A2-3200-T-1892 | 1    | Carrier & Cap Assembly | Carrier and cap update kit (with diff. lock)           |
| 2    | KIT 2691       | 1    | Shift Cylinder Kit     | RR-23-160, RR-23-164, RR-26-160, RS-23-160, RS-23-161, |
| 3    | 3296-B-1172    | 1    | Shift Fork             | RS-25-160, RS-26-160                                   |
| 4    | 2258-N-1262    | 1    | Spring                 | 3200-C-1823, 3200-D-1928, 3200-R-1708, 3200-T-1892,    |
| 5    | 2206-L-1156    | 1    | Elbow Fitting          | 3200-V-1894, 3200-K-2117                               |

## KIT 2763

| ITEM | PART NUMBER     | QTY. | DESCRIPTION            | REMARKS   |
|------|-----------------|------|------------------------|---|
| 1    | A2-3200-K-2117S | 1    | Carrier & Cap Assembly | Carrier and cap update kit (with diff. lock, with pump) |
| 2    | KIT 2691        | 1    | Shift Cylinder Kit     | RP-23-160, RP-23-164, RP-26-160                         |
| 3    | 3296-B-1172     | 1    | Shift Fork             | 3200-V-1894, 3200-Z-1820, 3200-K-2117                   |
| 4    | 2258-N-1262     | 1    | Spring                 |   |
| 5    | 2206-L-1156     | 1    | Elbow Fitting          |   |

## KIT 2764

| ITEM | PART NUMBER     | QTY. | DESCRIPTION            | REMARKS   |
|------|-----------------|------|------------------------|---|
| 1    | A2-3200-L-2118S | 1    | Carrier & Cap Assembly | Carrier and cap update kit (with diff. lock, less pump) |
| 2    | KIT 2691        | 1    | Shift Cylinder Kit     | RD-23-160, RD-23-164, RD-26-160                         |
| 3    | 3296-B-1172     | 1    | Shift Fork             | 3200-W-1895, 3200-Y-1819, 3200-L-2118                   |
| 4    | 2258-N-1262     | 1    | Spring                 |   |
| 5    | 2206-L-1156     | 1    | Elbow Fitting          |   |

## KIT 2766

| ITEM | PART NUMBER     | QTY. | DESCRIPTION            | REMARKS   |
|------|-----------------|------|------------------------|---|
| 1    | A2-3200-K-2117S | 1    | Carrier & Cap Assembly | Carrier and cap update kit (less diff. lock, with pump). RP-23-160, |
| 2    | 1250-U-1217     | 1    | Plug                   | RP-23-164, RP-26-160. 3200-V-1894, 3200-Z-1820, 3200-K-2117         |

## KIT 2796

| ITEM | PART NUMBER    | QTY. | DESCRIPTION                | REMARKS  |
|------|----------------|------|----------------------------|--|
| 1    | A1-3235-A-2393 | 1    | Differential Case Assembly | I.A.D. assembly. RD-23-160, RD-23-164, RD-26-160, RP-23-160, |
| 2    | KIT 2424       | 1    | IAD Kit with Spider        | RP-23-164, RP-26-160   |

## KIT 2824

| ITEM | PART NUMBER   | QTY. | DESCRIPTION         | REMARKS               |
|------|---------------|------|---------------------|-----------------------|
| 1    | A-3261-A-1067 | 1    | DCDL Shift Cylinder | Main differential kit |
| 2    | 2244-Z-1222   | 1    | Push Rod            | 160 Series            |

## KIT 2825

| ITEM | PART NUMBER    | QTY. | DESCRIPTION        | REMARKS    |
|------|----------------|------|--------------------|------------|
| 1    | A4-3261-Q-1057 | 1    | IAD Shift Cylinder | I.A.D. kit |
| 2    | 2244-Y-1221    | 1    | Push Rod           | 160 Series |

# SERVICE KITS

## KIT 2826

| ITEM | PART NUMBER | QTY. | DESCRIPTION | REMARKS                        |
|------|-------------|------|-------------|--------------------------------|
| 1    | 40-X-1233   | 1    | Locknut     | Input shaft nut and washer kit |
| 2    | 1229-N-1730 | 1    | Washer      |                                |

## KIT 2830

| ITEM | PART NUMBER | QTY. | DESCRIPTION    | REMARKS            |
|------|-------------|------|----------------|--------------------|
| 1    | 2214-N-1262 | 1    | Adjusting Ring | Adjusting ring kit |
| 2    | 1229-F-4452 | 2    | Snap Ring      |                    |

## KIT 2902

| ITEM | PART NUMBER   | QTY. | DESCRIPTION   | REMARKS      |
|------|---------------|------|---------------|--------------|
| 1    | A-2297-C-8765 | 1    | Breather      | Breather kit |
| 2    | A-3196-J-1336 | 1    | Breather Tube |              |

## KIT 4284

| ITEM | PART NUMBER | QTY. | DESCRIPTION | REMARKS                    |
|------|-------------|------|-------------|----------------------------|
| 1    | 41-X-1637   | 2    | Capscrew    | Lock pin kit<br>160 Series |
| 2    | 1199-R-2176 | 2    | Cotter Pin  |                            |
| 3    | 1246-P-1134 | 1    | Spirol Pin  |                            |

## KIT 4288

| ITEM | PART NUMBER | QTY. | DESCRIPTION | REMARKS   |
|------|-------------|------|-------------|---|
| 1    | 10-X-1595   | 4    | Bolt        | For Tapered Dowel 164EH Forward Carriers<br>RD-23-164, RP-23-164<br>3200-J-2116, 3200-K-2117, 3200-L-2118 |
| 2    | 10-X-1599   | 2    | Bolt        |   |
| 3    | 1246-V-1166 | 6    | Dowel       |   |

## KIT 4291

| ITEM | PART NUMBER | QTY. | DESCRIPTION | REMARKS   |
|------|-------------|------|-------------|---|
| 1    | 10-X-1595   | 3    | Bolt        | Tapered Dowel for RR-23-164<br>3200-E-2137, 3200-F-2138 |
| 2    | 10-X-1767   | 1    | Bolt        |   |
| 3    | 1246-V-1166 | 4    | Dowel       |   |

## KIT 4415

| ITEM | PART NUMBER    | QTY. | DESCRIPTION       | REMARKS  |
|------|----------------|------|-------------------|--|
| 1    | A1-1205-A-2731 | 1    | Oil Seal Assembly | RS-23-160, RS-23-161, RS-25-160, RS-26-160<br>3200-C-1511, 3200-T-1658, 3200-V-1660, 3200-Z-1560 |
| 2    | HM813843       | 1    | Bearing Cone      |  |
| 3    | 9220           | 1    | Bearing Cup       |  |
| 4    | HM813810       | 1    | Bearing Cup       |  |
| 5    | A1-1228-B-600  | 2    | Bearing Assembly  |  |
| 6    | 1228-V-594     | 1    | Bearing           |  |
| 7    | A1-1228-P-1004 | 1    | Bearing Assembly  |  |

## KIT 4420

| ITEM | PART NUMBER   | QTY. | DESCRIPTION       | REMARKS   |
|------|---------------|------|-------------------|---|
| 1    | 65500         | 1    | Bearing Cup       | RD-23-160, RD-23-164, RD-26-160, RP-23-160, RP-23-164,<br>RP-26-160<br>3200-J-1648, 3200-P-1628 |
| 2    | 65237         | 1    | Bearing Cone      |   |
| 3    | H715311       | 1    | Bearing Cup       |   |
| 4    | H715343       | 1    | Bearing Cone      |   |
| 5    | HM813810      | 1    | Bearing Cup       |   |
| 6    | HM813843      | 1    | Bearing Cone      |   |
| 7    | JLM714110     | 1    | Bearing Cup       |   |
| 8    | JLM714149     | 1    | Bearing Cone      |   |
| 9    | A1-1228-B-600 | 2    | Bearing Assembly  |   |
| 10   | A-1205-X-2728 | 1    | Oil Seal Assembly |   |
| 11   | 5-X-1034      | 1    | O-Ring            |   |
| 12   | 5-X-1343      | 1    | O-Ring            |   |



# SERVICE KITS

## KIT 4422

| ITEM | PART NUMBER   | QTY. | DESCRIPTION               | REMARKS   |
|------|---------------|------|---------------------------|---|
| 1    | 592A          | 2    | Bearing Cup               | RD-23-160, RD-23-164, RD-26-160<br>3200-K-1857, 3200-M-1703, 3200-Q-1837, 3200-X-1818,<br>3200-J-2116 |
| 2    | 594A          | 2    | Differential Bearing Cone |   |
| 3    | 65237         | 1    | Bearing Cone              |   |
| 4    | 65500         | 1    | Bearing Cup               |   |
| 5    | H715311       | 1    | Bearing Cup               |   |
| 6    | H715343       | 1    | Bearing Cone              |   |
| 7    | HM813810      | 1    | Bearing Cup               |   |
| 8    | HM813843      | 1    | Bearing Cone              |   |
| 9    | JLM714110     | 1    | Bearing Cup               |   |
| 10   | JLM714149     | 1    | Bearing Cone              |   |
| 11   | 5-X-1343      | 1    | O-Ring                    |   |
| 12   | A-1205-X-2728 | 1    | Oil Seal Assembly         |   |

## KIT 4423

| ITEM | PART NUMBER   | QTY. | DESCRIPTION               | REMARKS   |
|------|---------------|------|---------------------------|---|
| 1    | 52400         | 1    | Differential Bearing Cone | For all diff. lock capable except original design.<br>RD-23-160, RD-23-164, RD-26-160, RP-23-160, RP-23-164,<br>RP-26-160<br>3200-K-1701, 3200-L-1858, 3200-V-1894, 3200-W-1713,<br>3200-W1895, 3200-Y-1819, 3200-Z-1820, 3200-K-2117,<br>3200-L-2118 |
| 2    | 52618         | 1    | Bearing Cup               |   |
| 3    | 592A          | 1    | Bearing Cup               |   |
| 4    | 594A          | 1    | Differential Bearing Cone |   |
| 5    | 65237         | 1    | Bearing Cone              |   |
| 6    | 65500         | 1    | Bearing Cup               |   |
| 7    | A-1205-X-2728 | 1    | Oil Seal Assembly         |   |
| 8    | H715343       | 1    | Bearing Cone              |   |
| 9    | H715311       | 1    | Bearing Cup               |   |
| 10   | HM-813810     | 1    | Bearing Cup               |   |
| 11   | HM813843      | 1    | Bearing Cone              |   |
| 12   | JLM714110     | 1    | Bearing Cup               |   |
| 13   | JLM714149     | 1    | Bearing Cone              |   |
| 14   | 5-X-1034      | 1    | O-Ring                    |   |
| 15   | 5-X-1343      | 1    | O-Ring                    |   |

## KIT 4426

| ITEM | PART NUMBER    | QTY. | DESCRIPTION               | REMARKS   |
|------|----------------|------|---------------------------|---|
| 1    | 1228-B-1042    | 1    | Spigot Bearing            | Less Diff. Lock<br>RS-23-160, RS-23-161, RS-25-160, RS-26-160<br>3200-A-1821, 3200-H-1854, 3200-J-1856, 3200-P-1706 |
| 2    | 1228-V-594     | 1    | Bearing                   |   |
| 3    | A1-1205-A-2731 | 1    | Oil Seal Assembly         |   |
| 4    | 592A           | 2    | Bearing Cup               |   |
| 5    | 594A           | 2    | Differential Bearing Cone |   |
| 6    | 9220           | 1    | Bearing Cup               |   |
| 7    | HM813810       | 1    | Bearing Cup               |   |
| 8    | HM813843       | 1    | Bearing Cone              |   |

## KIT 4428

| ITEM | PART NUMBER    | QTY. | DESCRIPTION               | REMARKS  |
|------|----------------|------|---------------------------|--|
| 1    | 1228-B-1042    | 1    | Spigot Bearing            | With Diff. Lock<br>RS-23-160, RS-23-161, RS-25-160, RS-26-160<br>3200-C-1823, 3200-D-1928, 3200-E-1825, 3200-E-1929,<br>3200-R-1708, 3200-T-1892, 3200-V-1712, 3200-Y-1897 |
| 2    | 1228-V-594     | 1    | Bearing                   |  |
| 3    | A1-1205-A-2731 | 1    | Oil Seal Assembly         |  |
| 4    | 52400          | 1    | Differential Bearing Cone |  |
| 5    | 52618          | 1    | Bearing Cup               |  |
| 6    | 592A           | 1    | Bearing Cup               |  |
| 7    | 594A           | 1    | Differential Bearing Cone |  |
| 8    | 9220           | 1    | Bearing Cup               |  |
| 9    | HM813810       | 1    | Bearing Cup               |  |
| 10   | HM813843       | 1    | Bearing Cone              |  |

## KIT 4429

| ITEM | PART NUMBER | QTY. | DESCRIPTION  | REMARKS         |
|------|-------------|------|--------------|-----------------|
| 1    | 3237-R-1292 | 1    | DCDL Switch  | DCDL Switch Kit |
| 2    | 3237-X-1298 | 1    | DCDL Harness |                 |

# SERVICE KITS

## KIT 4745

| ITEM | PART NUMBER | QTY. | DESCRIPTION | REMARKS   |
|------|-------------|------|-------------|---|
| 1    | 41-X-1555   | 12   | Capscrew    | Coach Quality gear to case bolt kit (16.5 mm bolts after 4-88)<br>RD-23-160, RD-23-164, RD-26-160, RP-23-160, RP-23-164,<br>RP-26-160, RR-23-160, RR-23-164, RR-26-160, RS-23-160,<br>RS-23-161, RS-25-160, RS-26-160 |
| 2    | 40-X-1182   | 12   | Lock Nut    |   |
| 3    | 1229-U-1503 | 12   | Washer      |   |

## KIT 2468 391

| ITEM | PART NUMBER    | QTY. | DESCRIPTION                | REMARKS  |
|------|----------------|------|----------------------------|--|
| 1    | A2-3235-F-1982 | 1    | Unloaded Differential Case | Diff. case and gearset update with diff. lock, prior to 9/1/88.<br>RS-23-160, RS-23-161, RS-25-160, RS-26-160<br>3200-Z-1560 |
| 2    | A-39884-6      | 1    | Gearset                    |  |
| 3    | KIT 2426       | 1    | Bolt Kit                   |  |

## KIT 2468 410

| ITEM | PART NUMBER    | QTY. | DESCRIPTION                | REMARKS  |
|------|----------------|------|----------------------------|--|
| 1    | A2-3235-F-1982 | 1    | Unloaded Differential Case | Diff. case and gearset update with diff. lock, prior to 9/1/88.<br>RS-23-160, RS-23-161, RS-25-160, RS-26-160<br>3200-Z-1560 |
| 2    | A-39886-6      | 1    | Gearset                    |  |
| 3    | KIT 2426       | 1    | Bolt Kit                   |  |

## KIT 2468 430

| ITEM | PART NUMBER    | QTY. | DESCRIPTION                | REMARKS  |
|------|----------------|------|----------------------------|--|
| 1    | A2-3235-F-1982 | 1    | Unloaded Differential Case | Diff. case and gearset update with diff. lock, prior to 9/1/88.<br>RS-23-160, RS-23-161, RS-25-160, RS-26-160<br>3200-Z-1560 |
| 2    | A-39888-6      | 1    | Gearset                    |  |
| 3    | KIT 2426       | 1    | Bolt Kit                   |  |

## KIT 2468 456

| ITEM | PART NUMBER    | QTY. | DESCRIPTION                | REMARKS  |
|------|----------------|------|----------------------------|--|
| 1    | A2-3235-F-1982 | 1    | Unloaded Differential Case | Diff. case and gearset update with diff. lock, prior to 9/1/88.<br>RS-23-160, RS-23-161, RS-25-160, RS-26-160<br>3200-Z-1560 |
| 2    | A-39890-6      | 1    | Gearset                    |  |
| 3    | KIT 2426       | 1    | Bolt Kit                   |  |

## KIT 2655 391

| ITEM | PART NUMBER     | QTY. | DESCRIPTION                | REMARKS  |
|------|-----------------|------|----------------------------|--|
| 1    | A-39884-6       | 1    | Gearset                    | Diff. case and gearset upgrade kit.<br>RS-23-160, RS-23-161, RS-25-160, RS-26-160<br>3200-C-1511 |
| 2    | A12-3235-F-1982 | 1    | Unloaded Differential Case |  |
| 3    | KIT 2426        | 1    | Bolt Kit                   |  |

## KIT 2655 410

| ITEM | PART NUMBER     | QTY. | DESCRIPTION                | REMARKS  |
|------|-----------------|------|----------------------------|--|
| 1    | A-39886-6       | 1    | Gearset                    | Diff. case and gearset upgrade kit.<br>RS-23-160, RS-23-161, RS-25-160, RS-26-160<br>3200-C-1511 |
| 2    | A12-3235-F-1982 | 1    | Unloaded Differential Case |  |
| 3    | KIT 2426        | 1    | Bolt Kit                   |  |

## KIT 2655 430

| ITEM | PART NUMBER     | QTY. | DESCRIPTION                | REMARKS  |
|------|-----------------|------|----------------------------|--|
| 1    | A-39888-6       | 1    | Gearset                    | Diff. case and gearset upgrade kit.<br>RS-23-160, RS-23-161, RS-25-160, RS-26-160<br>3200-C-1511 |
| 2    | A12-3235-F-1982 | 1    | Unloaded Differential Case |  |
| 3    | KIT 2426        | 1    | Bolt Kit                   |  |

## KIT 2655 456

| ITEM | PART NUMBER     | QTY. | DESCRIPTION                | REMARKS  |
|------|-----------------|------|----------------------------|--|
| 1    | A-39890-6       | 1    | Gearset                    | Diff. case and gearset upgrade kit.<br>RS-23-160, RS-23-161, RS-25-160, RS-26-160<br>3200-C-1511 |
| 2    | A12-3235-F-1982 | 1    | Unloaded Differential Case |  |
| 3    | KIT 2426        | 1    | Bolt Kit                   |  |

## NUMERICAL PARTS LISTING

| Part Number    | Page |
|----------------|------|
| 4-X-1921       | 15   |
| 4-X-1922       | 15   |
| 5-X-521        | 6,13 |
| 5-X-1034       | 7    |
| 5-X-1153       | 6,13 |
| 5-X-1198       | 6,13 |
| 5-X-1343       | 3    |
| 10-X-1334      | 3    |
| 10-X-1594      | 4,15 |
| 10-X-1595      | 15   |
| 10-X-1599      | 4,15 |
| 10-X-1600      | 15   |
| 15-X-387       | 14   |
| 15-X-1167      | 4,10 |
| 19-X-1087      | 6,10 |
| 40-X-1145      | 4    |
| 40-X-1182      | 6,10 |
| 40-X-1233      | 3,9  |
| 40-X-1237      | 14   |
| 41-X-1018      | 6,10 |
| 41-X-1022      | 6,13 |
| 41-X-1208      | 3    |
| 41-X-1275      | 5,12 |
| 41-X-1276      | 6,10 |
| 41-X-1333      | 6,13 |
| 41-X-1364      | 6,13 |
| 41-X-1368      | 6,13 |
| 42-X-1024      | 6,10 |
| 42-X-1027      | 6,13 |
| 42-X-1408      | 7,13 |
| 43-X-1006      | 6,13 |
| 43-X-1007      | 7,13 |
| 46-X-1029      | 10   |
| A-1199-W-4053  | 15   |
| 1199-E-1669    | 15   |
| A-1205-T-696   | 15   |
| A-1205-Q-2487  | 15   |
| A1-1205-X-2728 | 3    |
| A1-1205-Y-2729 | 13   |
| A1-1205-A-2731 | 9    |
| 1220-K-89      | 13   |
| 1227-R-330     | 15   |
| 1227-D-472     | 4,10 |
| 1227-W-517     | 15   |
| 1227-P-1056    | 6,13 |
| 1228-V-594     | 9    |
| A1-1228-B-600  | 5,10 |
| A1-1228-P-1004 | 9    |
| 1228-B-1042    | 9    |
| 1228-Y-1221    | 9    |
| 1229-U-1009    | 15   |

| Part Number  | Page      |
|--------------|-----------|
| 1229-U-1503  | 5,6,10,12 |
| 1229-W-1557  | 4,15      |
| 1229-K-1597  | 3,4,14    |
| 1229-E-1669  | 3,7       |
| 1229-N-1730  | 3,9       |
| 1229-T-1736  | 14        |
| 1229-P-2590  | 14        |
| 1229-Q-2591  | 14        |
| 1229-R-2592  | 14        |
| 1229-S-2593  | 14        |
| 1229-T-2594  | 14        |
| 1229-U-2595  | 14        |
| 1229-V-2596  | 14        |
| 1229-W-2597  | 14        |
| 1229-X-2598  | 14        |
| 1229-Y-2599  | 14        |
| 1229-Q-2929  | 3         |
| 1229-K-3001  | 6,12      |
| 1229-L-3002  | 6,12      |
| 1229-F-4062  | 7         |
| 1229-G-4063  | 4         |
| 1229-W-4131  | 14        |
| 1229-F-4452  | 7,13      |
| 1229-U-4519  | 7,13      |
| 1229-D-4528  | 7,13      |
| 1229-F-4634S | 15        |
| 1229-S-4985  | 3         |
| 1244-W-1765  | 4         |
| 1246-M-1131  | 7         |
| 1250-E-473   | 15        |
| 1250-N-1080  | 7         |
| 1250-T-1216  | 7,13      |
| 1250-U-1217  | 6,13      |
| 2203-F-2788  | 4         |
| 2203-G-2789  | 4         |
| 2203-H-2790  | 4         |
| 2203-K-9241  | 3         |
| 2203-L-9242  | 3         |
| 2203-M-9243  | 3         |
| 2203-V-9824  | 4         |
| 2203-W-9825  | 4         |
| 2203-X-9826  | 4         |
| 2203-Y-9827  | 4         |
| 2203-Z-9828  | 4         |
| 2203-A-9829  | 4         |
| 2203-B-9830  | 4         |
| 2203-C-9831  | 4         |
| 2203-D-9832  | 4         |
| 2203-E-9833  | 4         |
| 2203-F-9834  | 4         |
| 2203-G-9835  | 4         |

| Part Number    | Page |
|----------------|------|
| 2203-H-9836    | 4    |
| 2203-J-9838    | 4    |
| 2203-K-9839    | 4    |
| 2203-L-9840    | 4    |
| 2208-H-944     | 6,13 |
| 2208-L-1000    | 6,13 |
| 2214-G-1125    | 5,10 |
| 2214-J-1128    | 5,10 |
| 2214-Z-1144    | 4,10 |
| 2214-U-1269    | 4,10 |
| 2230-N-170     | 6,13 |
| 2233-K-245     | 3    |
| 2233-M-1001    | 6,12 |
| 2234-C-1069    | 6,12 |
| 2234-D-1070    | 12   |
| 2234-T-1190    | 3    |
| 2244-Y-51      | 6,13 |
| 2244-L-1026    | 6,13 |
| 2258-U-411     | 3    |
| 2258-L-714     | 6,13 |
| 2258-Z-1118    | 7    |
| 2258-G-1255    | 7,13 |
| 2258-N-1262    | 6,13 |
| 2297-T-4180    | 10   |
| 2297-U-5273    | 7    |
| 2297-Z-5278    | 7    |
| A-2297-D-5334  | 7    |
| 2297-S-5349    | 3    |
| 2297-C-7049    | 12   |
| 2803-D-2500    | 9    |
| 2803-E-2501    | 9    |
| 2803-F-2502    | 9    |
| 2803-G-2503    | 9    |
| 2803-H-2504    | 9    |
| 2803-J-2506    | 9    |
| 2803-K-2507    | 9    |
| 2803-L-2508    | 9    |
| 2803-M-2509    | 9    |
| 2803-N-2510    | 9    |
| 2803-Y-2755    | 9    |
| 2803-Z-2756    | 9    |
| 2803-A-2757    | 9    |
| 2803-B-2758    | 9    |
| 3107-F-1020    | 6,13 |
| 3107-P-1030    | 13   |
| 3107-B-1094    | 6,13 |
| 3107-C-1095    | 13   |
| 3107-P-1212    | 3    |
| 3196-F-32      | 6,13 |
| A2-3200-P-1706 | 10   |
| A2-3200-A-1821 | 10   |

## NUMERICAL PARTS LISTING

| Part Number     | Page |
|-----------------|------|
| A2-3200-Q-1837  | 3    |
| A2-3200-H-1854  | 10   |
| A2-3200-J-1856  | 10   |
| A2-3200-K-1857  | 3    |
| A2-3200-L-1858  | 3    |
| A2-3200-T-1892  | 10   |
| A2-3200-Y-1897  | 10   |
| A2-3200-J-1908  | 3    |
| A2-3200-K-1909  | 3,4  |
| A2-3200-D-1928  | 10   |
| A2-3200-E-1929  | 10   |
| A2-3200-J-2116S | 3    |
| A2-3200-L-2118S | 3    |
| A2-3200-K-2117S | 3,4  |
| A2-3200-E-2137  | 10   |
| A2-3200-F-2138  | 10   |
| 3202-X-8110     | 18   |
| 3202-Y-8683     | 18   |
| 3202-P-8804     | 18   |
| 3202-Q-8805     | 18   |
| 3202-R-8806     | 18   |
| 3202-A-8815     | 18   |
| 3202-B-8816     | 18   |
| 3202-C-8817     | 18   |
| 3202-G-9003     | 18   |
| 3202-H-9004     | 18   |
| 3202-Y-9125     | 18   |
| 3202-Z-9126     | 18   |
| 3202-A-9127     | 18   |
| 3202-B-9128     | 18   |
| 3202-C-9129     | 18   |
| 3202-D-9130     | 18   |
| 3202-J-9344     | 18   |
| 3202-K-9345     | 18   |
| 3202-L-9346     | 18   |
| 3202-G-9393     | 18   |
| 3202-Q-9403     | 18   |
| 3202-Y-9489     | 18   |
| 3202-Z-9490     | 18   |
| 3202-A-9491     | 18   |
| 3202-K-9553     | 18   |
| 3202-E-9573     | 18   |
| 3202-F-9574     | 18   |
| 3202-G-9575     | 18   |
| 3202-A-9647     | 18   |
| 3202-J-9916     | 18   |
| 3202-L-9918     | 18   |
| 3206-T-1190     | 18   |
| 3206-X-1532     | 18   |
| 3206-Z-1534     | 18   |
| 3216-G-4375     | 7,13 |

| Part Number     | Page  |
|-----------------|-------|
| 3221-P-1004     | 3     |
| A-3226-R-1006   | 9     |
| A-3226-T-1112   | 14    |
| A2-3226-T-1112S | 14    |
| A-3226-H-1126   | 3     |
| A-3226-S-1137   | 3     |
| A-3230-C-1043   | 6,12  |
| A-3235-S-1813   | 12    |
| A2-3235-S-1813  | 11,12 |
| A10-3235-S-1813 | 5,12  |
| A11-3235-S-1813 | 5,11  |
| A12-3235-S-1813 | 5,12  |
| A13-3235-S-1813 | 5,11  |
| A14-3235-S-1813 | 6,11  |
| A2-3235-F-1982  | 12    |
| A3-3235-F-1982  | 11    |
| A10-3235-F-1982 | 5,12  |
| A11-3235-F-1982 | 5,11  |
| A12-3235-F-1982 | 5,12  |
| A13-3235-F-1982 | 5,11  |
| A14-3235-F-1982 | 6,11  |
| A-3235-H-1984   | 12    |
| A2-3235-H-1984  | 12    |
| A3-3235-H-1984  | 11    |
| A10-3235-H-1984 | 5,12  |
| A11-3235-H-1984 | 5,11  |
| A12-3235-H-1984 | 5,12  |
| A13-3235-H-1984 | 5,11  |
| A14-3235-H-1984 | 6,11  |
| A-3235-C-2109   | 5,12  |
| A1-3235-C-2109  | 5,11  |
| A2-3235-C-2109  | 5,12  |
| A3-3235-C-2109  | 5,11  |
| A5-3235-C-2109  | 5,12  |
| A6-3235-C-2109  | 5,11  |
| A7-3235-C-2109  | 6,11  |
| A8-3235-C-2109  | 6,11  |
| A-3235-E-2111   | 5,12  |
| A1-3235-E-2111  | 5,11  |
| A2-3235-E-2111  | 5,12  |
| A3-3235-E-2111  | 5,11  |
| A5-3235-E-2111  | 5,12  |
| A6-3235-E-2111  | 5,11  |
| A7-3235-E-2111  | 6,11  |
| A8-3235-E-2111  | 6,11  |
| A-3235-G-2113   | 5,12  |
| A1-3235-G-2113  | 5,11  |
| A2-3235-G-2113  | 5,12  |
| A3-3235-G-2113  | 5,11  |
| A5-3235-G-2113  | 5,12  |
| A6-3235-G-2113  | 5,11  |

| Part Number     | Page    |
|-----------------|---------|
| A7-3235-G-2113  | 6,11    |
| A8-3235-G-2113  | 6,11    |
| A1-3235-R-2176  | 6,12    |
| A2-3235-R-2176  | 5,11    |
| A4-3235-R-2176  | 5,11    |
| A5-3235-R-2176  | 6,12    |
| A1-3235-S-2177  | 6,12    |
| A2-3235-S-2177  | 5,11    |
| A4-3235-S-2177  | 5,11    |
| A5-3235-S-2177  | 6,12    |
| A1-3235-T-2178  | 6,12    |
| A2-3235-T-2178  | 5,11    |
| A3-3235-T-2178  | 6,12    |
| A4-3235-T-2178  | 11      |
| A-3235-R-2202   | 12      |
| A1-3235-R-2202  | 11      |
| A2-3235-R-2202  | 12      |
| A3-3235-R-2202  | 11      |
| A1-3235-A-2393  | 3       |
| A3-3235-A-2393  | 3       |
| A5-3235-A-2393  | 3       |
| A-3261-L-350    | 3       |
| 3264-N-1522     | 7       |
| 3266-F-1020     | 6,13    |
| 3266-C-1095     | 4       |
| 3278-N-300      | 3       |
| 3278-W-335      | 6,12    |
| 3280-V-8394     | 7       |
| SA1-3280-X-9150 | 7,13    |
| SA2-3280-X-9150 | 7,13    |
| 3296-B-184      | 7,13    |
| 3296-Y-1169     | 7,13    |
| 3296-B-1172     | 7,13    |
| 3296-B-1328     | 3       |
| 3297-V-1010     | 14      |
| A1-3297-S-1605  | 3       |
| A-3297-T-1606   | 3       |
| A-3303-P-1030   | 7       |
| 3892-U-4909     | 4       |
| 3892-T-4934     | 3       |
| 572             | 15      |
| 580             | 15      |
| 592A            | 5,10,15 |
| 594A            | 5,10,15 |
| 9220            | 9       |
| 52400           | 5,10    |
| 52618           | 5,10    |
| 65237           | 4       |
| 65500           | 4       |
| 16N-4-6241      | 19      |
| 16N-4-6271      | 19      |

## NUMERICAL PARTS LISTING

| Part Number   | Page |
|---------------|------|
| 16N-4-7341-1X | 21   |
| 16NYS38-8A    | 19   |
| 16NYS38-12A   | 19   |
| 16TYS32-76    | 21   |
| 176NYS38-14A  | 19   |
| 176TYS38-27A  | 21   |
| 17N-4-7181X   | 19   |
| 17N-4-7181-1X | 21   |
| 17N-4-7621-1  | 21   |
| 17N-4-7771X   | 19   |
| 17NYS32-99    | 19   |
| 17NYS32-100   | 19   |
| 17NYS38-61A   | 19   |
| 17TYS32-99    | 21   |
| 18N-4-3731X   | 19   |
| 18N-4-3731-1X | 21   |
| 5WCS38-18A    | 22   |
| 5WCS38-23A2   | 22   |
| 72NYS32-244   | 20   |
| 72NYS38-24A   | 20   |
| 72NYS38-26A   | 20   |
| 82NYS38-31A   | 20   |
| 92NYS32-26    | 20   |
| 92NYS38-73A   | 20   |
| A-39654-1     | 4    |
| A-39656-1     | 4    |
| A-39658-1     | 4    |
| A-39660-1     | 4    |
| A-39662-1     | 4    |
| A-39664-1     | 4    |
| A-39666-1     | 4    |
| A-39672-1     | 4    |
| A-39674-1     | 4    |
| A-39876-1     | 4    |
| A-39878-1     | 4    |
| A-39880-1     | 4    |
| A-39882-1     | 4    |
| A-39884-5     | 9    |
| A-39886-5     | 9    |
| A-39888-5     | 9    |
| A-39890-5     | 9    |
| A-39892-1     | 4    |
| A-39896-1     | 4    |
| A-39898-5     | 9    |
| A-39900-5     | 9    |
| A-39902-5     | 9    |
| A-39904-5     | 9    |
| A-39906-5     | 9    |
| A-40024-5     | 9    |
| A-40104-5     | 9    |
| A-40106-5     | 9    |

| Part Number  | Page  |
|--------------|-------|
| A-40110-5    | 9     |
| A-40116-5    | 9     |
| A-40122-5    | 9     |
| A-41064-1    | 4     |
| A-41066-1    | 9     |
| A-41572-1    | 9     |
| A-41574-1    | 9     |
| A-41828-1    | 9     |
| A-41988-1    | 9     |
| A-41990-1    | 9     |
| A-41992-1    | 9     |
| A-41994-1    | 9     |
| A-41996-1    | 9     |
| A-41998-1    | 9     |
| A-42000-1    | 9     |
| A-42002-1    | 9     |
| A-42004-1    | 9     |
| A-42006-1    | 9     |
| A-42196-1    | 9     |
| A-42466-1    | 9     |
| A-42468-1    | 9     |
| A-42470-1    | 9     |
| A-42630-1    | 9     |
| B-42776-1    | 9     |
| B-43454-1    | 9     |
| H715311      | 4     |
| H715343      | 4     |
| HM813810     | 3,9   |
| HM813843     | 3,9   |
| JLM104910    | 14    |
| JLM714110    | 3     |
| JLM714149    | 3     |
| KIT 576      | 29    |
| KIT 1592     | 29    |
| KIT 1593     | 29    |
| KIT 2317     | 29    |
| KIT 2318     | 11,29 |
| KIT 2341     | 29    |
| KIT 2397     | 30    |
| KIT 2406     | 30    |
| KIT 2414     | 30    |
| KIT 2424     | 30    |
| KIT 2426     | 31    |
| KIT 2429     | 31    |
| KIT 2468 391 | 41    |
| KIT 2468 410 | 41    |
| KIT 2468 430 | 41    |
| KIT 2468 456 | 41    |
| KIT 2483     | 31    |
| KIT 2489     | 31    |
| KIT 2575     | 31    |

| Part Number  | Page    |
|--------------|---------|
| KIT 2614     | 31      |
| KIT 2615     | 32      |
| KIT 2616     | 4,32    |
| KIT 2618     | 3,32    |
| KIT 2624     | 3,7,32  |
| KIT 2637     | 33      |
| KIT 2638     | 33      |
| KIT 2640     | 4,33    |
| KIT 2640A    | 4,33    |
| KIT 2640B    | 4,33    |
| KIT 2641     | 34      |
| KIT 2641A    | 34      |
| KIT 2641B    | 34      |
| KIT 2642     | 10,34   |
| KIT 2642A    | 10,34   |
| KIT 2642B    | 10,35   |
| KIT 2643     | 10,35   |
| KIT 2643A    | 10,35   |
| KIT 2643B    | 10,35   |
| KIT 2644     | 3,35    |
| KIT 2644A    | 3,36    |
| KIT 2644B    | 3,36    |
| KIT 2655 391 | 41      |
| KIT 2655 410 | 41      |
| KIT 2655 430 | 41      |
| KIT 2655 456 | 41      |
| KIT 2657     | 10,36   |
| KIT 2657A    | 10,36   |
| KIT 2657B    | 10,36   |
| KIT 2658     | 10,37   |
| KIT 2658A    | 10,37   |
| KIT 2658B    | 10,37   |
| KIT 2659     | 10,37   |
| KIT 2691     | 37      |
| KIT 2698     | 38      |
| KIT 2750     | 38      |
| KIT 2762     | 10,38   |
| KIT 2763     | 4,38    |
| KIT 2764     | 3,38    |
| KIT 2766     | 38      |
| KIT 2796     | 38      |
| KIT 2824     | 6,13,38 |
| KIT 2825     | 3,38    |
| KIT 2826     | 3,39    |
| KIT 2830     | 5,10    |
| KIT 2902     | 39      |
| KIT 4284     | 6,10,39 |
| KIT 4288     | 39      |
| KIT 4291     | 39      |
| KIT 4415     | 39      |
| KIT 4420     | 39      |

## NUMERICAL PARTS LISTING

| Part Number  | Page    |
|--------------|---------|
| KIT 4422     | 40      |
| KIT 4423     | 40      |
| KIT 4426     | 40      |
| KIT 4428     | 40      |
| KIT 4429     | 6,13,40 |
| KIT 4745     | 41      |
| KIT RP23160  | 28      |
| KIT RP23160A | 28      |
| KIT RP23160B | 28      |
| KIT RR23160  | 28      |
| KIT RR23160A | 28      |
| KIT RR23160B | 28      |
| LM-104949    | 14      |
| MN-312-1     | 3       |
| MS-208016-1  | 3       |
| MS-208020-1  | 13      |
| MS-208045-1  | 7       |
| MS-210016-1  | 6,13    |
| MS-210045A-1 | 3       |
| MS-212040-2  | 3       |
| MS-212045-1  | 9       |
| MWA-506      | 6,13    |
| MWA-508      | 13      |
| MWA-512      | 3,9     |
| N-110-1      | 15      |
| NL-110-1     | 4       |
| P-28-S       | 15      |
| P-212        | 15      |

| Part Number | Page |
|-------------|------|
|-------------|------|

| Part Number | Page |
|-------------|------|
|-------------|------|

## NOTES

## NOTES



## **MERITOR AFTERMARKET PARTS WARRANTY**

We warrant all new parts for one year from date of shipment to the buyer against defective material or workmanship (but not against damage caused by accident, abuse or improper installation, maintenance or repair) when such parts are used on vehicles the specifications of which have been approved by our Engineering Department.

As the exclusive remedy under this warranty, we will, at our option, repair or replace such parts free of charge, or take back the nonconforming parts and refund the monies paid by buyer for such parts, if found on examination by us to be nonconforming and if any necessary return charges are prepaid.

If it is necessary to return any parts under this warranty, buyer agrees not to make any deduction on account thereof from remittances on current accounts while claims are in the process of disposition. Any expense incurred without our consent for repairs or replacement will not be allowed.

**THIS WARRANTY IS EXPRESSLY IN LIEU OF ALL OTHER WARRANTIES OR CONDITIONS, EXPRESS, IMPLIED OR STATUTORY, INCLUDING ANY IMPLIED WARRANTY OF MERCHANTABILITY OR FITNESS FOR PARTICULAR PURPOSE. IN NO EVENT SHALL SELLER BE LIABLE FOR INCIDENTAL OR CONSEQUENTIAL DAMAGES OF ANY NATURE.**

Only genuine Meritor replacement parts are covered by this aftermarket parts warranty.

Distributed by:



**ArvinMeritor**<sup>™</sup>

Meritor Heavy Vehicle Systems, LLC  
7975 Dixie Highway  
Florence, Kentucky 41042 USA  
888-725-9355

arvinmeritor.com  
XpresswayPlus.arvinmeritor.com

Information contained in this publication was in effect at the time the publication was approved for printing and is subject to change without notice or liability. ArvinMeritor reserves the right to revise the information presented or discontinue the production of parts at any time.

Litho in USA  
Revised 09-10  
PB-9250 (13028/05060)  
©2010 ArvinMeritor, Inc.



## **Meritor Axle Model RT-40160 - RR-29160 - Carrier A-3200-E-2137**

Pro Gear parts and service manual for Meritor Axle Model RT-40160 - RR-29160 - Carrier A3200E2137 to assist you in identifying the correct configuration of your Meritor Axle. This Meritor A3200E2137 axle, is available and ready for international shipping. Call today!

If you need any assistance identifying the correct Meritor axle unit for your truck or equipment, contact your Meritor axle replacement specialists at Pro Gear and Transmission.

Pro Gear stocks every part for your Meritor axle RT40160 and RR29160. We have 1000's of products in shop that are ready to ship internationally for your next project.

For parts or service contact the Meritor specialists at Pro Gear & Transmission, Inc.

 CALL US

 EMAIL US

 VISIT MODEL PAGE

 VISIT ONLINE STORE