



MERITOR

**Meritor Differential Model RT-58-185 - RP-24-180/185 - Carrier
A84-3200-M-1833**

Pro Gear parts manual for Meritor Differential Model RT-58-185 - RP-24-180/185 - Carrier A84-3200-M-1833 to assist in identifying the correct configuration of your Meritor 380 Series differential. This Meritor Tandem Front Axle is built with 46 or 50 Axle spline and ratios available in 3.73 thru 10.62.

If you need any assistance identifying the correct Meritor differential unit for your truck or equipment, contact your Meritor differential replacement specialists at Pro Gear and Transmission.

Pro Gear stocks every part for your Meritor differential. We have 1000's of products in shop that are ready to ship internationally for your next project.

For parts or service contact the Meritor specialists at Pro Gear & Transmission, Inc.

 CALL US

 EMAIL US

 VISIT MODEL PAGE

 VISIT ONLINE STORE

MERITOR[®]

An **ArvinMeritor**[™] Brand

180, 185, 186 AND 380 SERIES
DRIVE AXLE PARTS FOR
SINGLE AXLES AND TANDEM AXLES



PB-9108
Revised 10/08

HOW TO USE THIS CATALOG

- There are 11 basic carriers covered in this catalog:

3200-C-1381	3200-K-1753	3200-S-1839
3200-U-1399	3200-W-1791	3200-A-1899
3200-M-1625	3200-J-1804	3200-L-1910
3200-J-1752	3200-M-1833	

Major assembly differences in a carrier are indicated by the different assembly level numbers in front of the base carrier number, for example, A1-3200-J-1804 and A4-3200-J-1804.

NOTE: The carriers listed in this catalog do not include yokes. A yoke is a major assembly difference, so, a carrier sold with a yoke has a different assembly level number than the same carrier without the yoke.

- The charts for carriers, output shafts, and housings include the following information:

- An exploded view of each assembly, keyed to the parts list.
- A description of each part.
- Parts that are sold as assemblies that include other parts.
- Which carriers or axle models the part is used on.
- The quantity of the part used on the carrier or axle.
- The part number of each part.
- Whether the part is available in a kit.

- **Carrier parts:**

Determine which chart and figure (1 or 2) applies to your carrier by using the following sources of information.

- Identification tag installed on the carrier.
- Axle Models-Carriers-Features Chart.
- Pictures and descriptions of the carriers inside the front cover and at the beginning of Chart 1 and Chart 2.

- **Output (thru) shafts:**

This chart covers the output shafts for the forward axles of all tandems. Note that the output shaft assembly or its components are only sold as separate items. The output shaft is not included with the purchase of a carrier or housing.

- **Housing Assemblies and Wheel End Parts:**

This chart covers the housing assemblies and wheel end parts for all axles. The parts are listed according to axle models that are used on 180 and 380 series axles.

- **Axle shafts:**

The axle shafts are grouped in sets (L.H. and R.H.) according to the axle models they are used on. Many axle shafts are used on more than one axle model. The axle shafts are also listed by part number with dimensions.

- **Yokes and Flanges:**

There are four charts that cover full round bearing yokes, wing bearing yokes, Easy Service yokes and flanges. Each chart lists the yokes or flanges used on each model, the yokes and flanges are listed by dimensions.

- **Kits:**

The first chart in this section lists all the kits available for each model axle and carrier. Following that chart, the kits are organized in numerical order.

- **Numerical Parts Index:**

This section lists every part number along with the page(s) on which the part is listed.

STANDARD CARRIER SUPERCESSION LIST

ORIGINAL PART NUMBER	REPLACEMENT PART NUMBER
A54-3200-U-1399	A1-3200-A-1899
A61-3200-U-1399	A1-3200-J-1804
A42-3200-M-1625	A84-3200-M-1833
A53-3200-M-1625	A58-3200-M-1833
A58-3200-M-1625	A73-3200-M-1833
A59-3200-M-1625	A12-3200-M-1833
A60-3200-M-1625	A74-3200-M-1833
A63-3200-M-1625	A76-3200-M-1833
A66-3200-M-1625	A17-3200-M-1833
A83-3200-M-1625	A36-3200-M-1833
B8-3200-M-1625	A97-3200-M-1833

ORIGINAL PART NUMBER	REPLACEMENT PART NUMBER
A-3200-K-1753	A-3200-J-1752
A1-3200-K-1753	A1-3200-J-1752
A1-3200-W-1791	A1-3200-A-1899
A11-3200-M-1833	A73-3200-M-1833
A13-3200-M-1833	A74-3200-M-1833
A15-3200-M-1833	A76-3200-M-1833
A48-3200-M-1833	A84-3200-M-1833
A1-3200-J-1804	A1-3200-J-1752
A1-3200-M-1899	A-3200-J-1752
B5-3200-A-1899	A-3200-K-1753
B8-3200-A-1899	A1-3200-K-1753

The part number supercessions listed here reflect product improvements made in several key areas. Several of these product improvements are non-interchangeable at the component level, in these cases kits have been developed to ease your transition to the new designs.

The rear-rear and single axle carriers with main diff. lock now have a screw-in type shifter.

The forward-rear carriers with pump now have an internal pump that is also used on the 145 and 160 family axles.

The forward-rear carriers also now have a screw-in type I.A.D. lock shift cylinder.

Rear Drive Axles

Model Numbers and Designations

Axle models are identified by a letter and number system. The letters and numbers give important information about the specific axle model.

The first seven positions of the designation identify a basic axle model, while the second group of letters and numbers identify particular specifications.

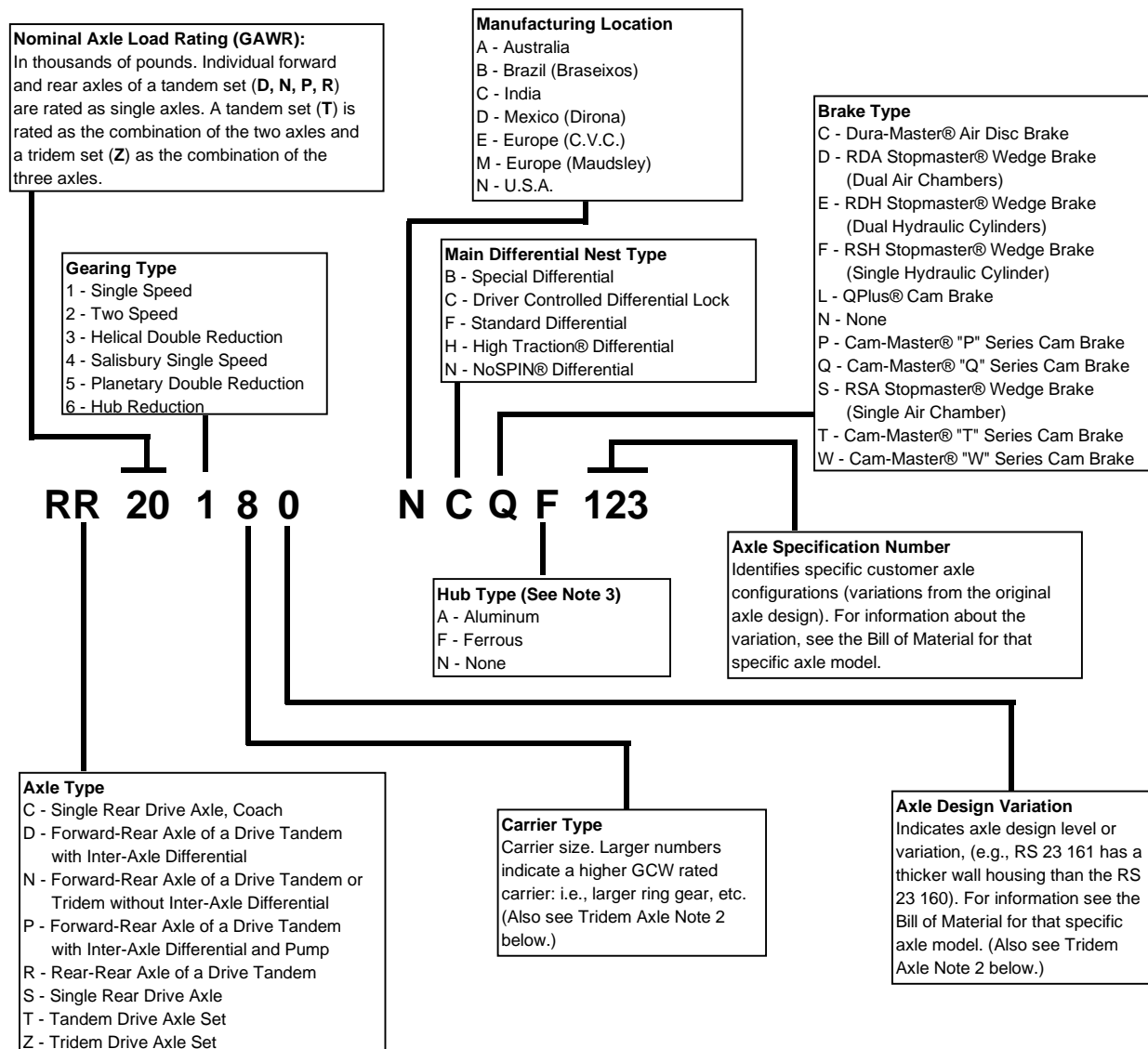

NOTE 1:

If a complete axle designation is not required, use the first seven positions of the model designation to identify the basic axle model.

EXAMPLES OF BASIC AXLE MODELS:

RS 17 140 - Single Rear Drive, 17,000 lb., Single Speed, 15" Ring Gear, 140 Carrier Model.

RT 48 380 - Tandem Drive Axle Set, 48,000 lb., Helical Double Reduction, 19.62" Ring Gear, 380 Carrier Model.

RZ 60 164 - Tridem Drive Axle Set, 60,000 lb., Single Speed, Includes a 150 Series Forward Rear or First Axle and a 145 Series Tandem Axle Set as the Second and Third Axles.

NOTE 2, FOR TRIDEM AXLES ONLY:

For a Tridem Drive Axle Set (RZ), the number in the sixth position designates the carrier in the first axle. The number in the seventh position designates the carriers in the second and third axles.

NOTE 3:

Some axle designations or specifications do not have a hub type code.

FIGURE 1

FORWARD CARRIERS (180 & 380 LESS IAD & LESS PUMP)

ALL REAR CARRIERS FOR 380 SERIES AXLES

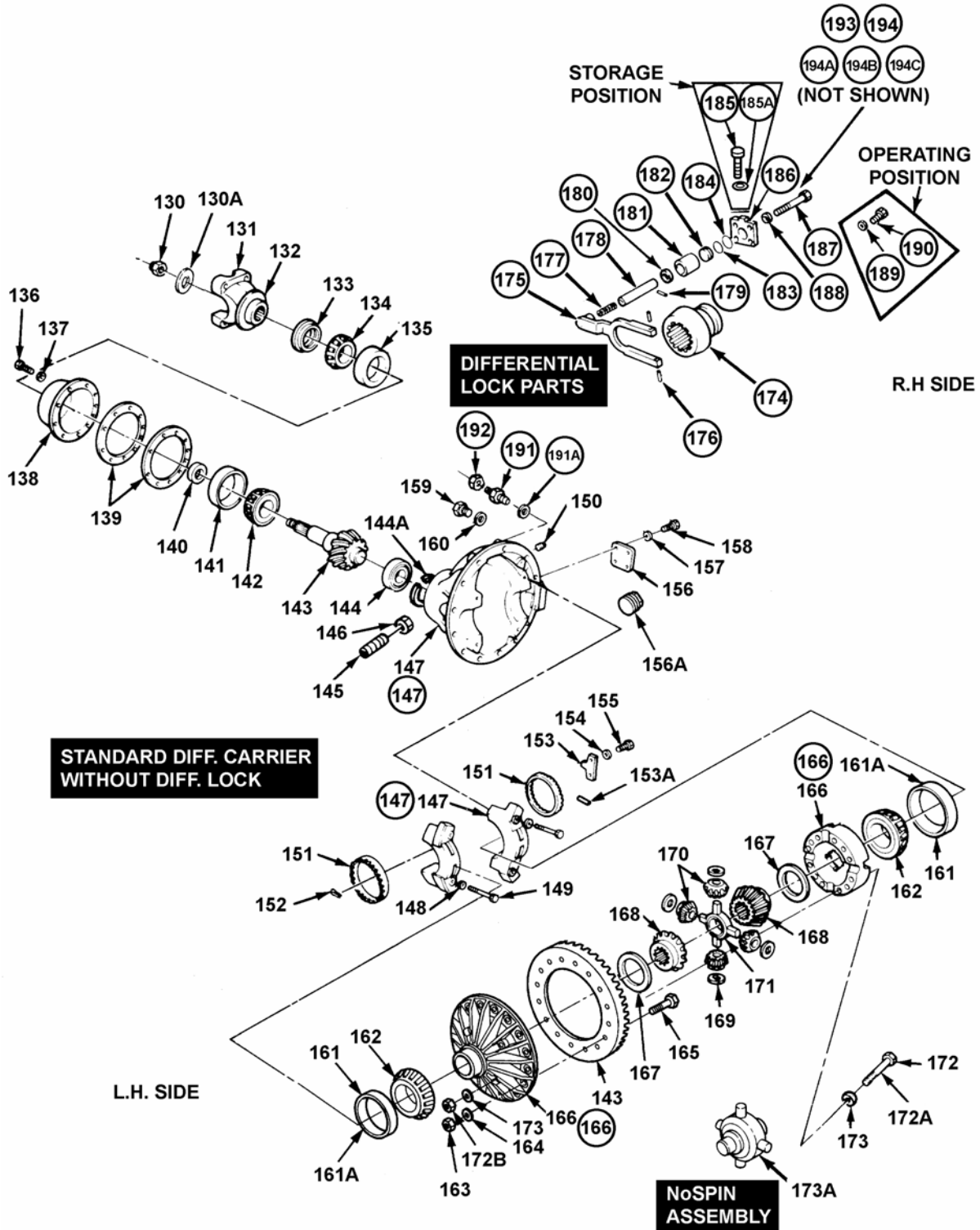

FIGURE 1A
ALL FORWARD CARRIERS
(180 & 380 WITH IAD & WITH PUMP)



SEE ITEMS 1-42 ON
 PREVIOUS ILLUSTRATION FOR
 MAIN DIFF. & GEARSET PARTS

FIGURE 2 REAR CARRIERS FOR 180/185/186 SERIES SINGLE AND TANDEM AXLES



• Circled ○ numbers are diff. lock parts or parts that change when diff. lock is added.

AXLE MODELS - CARRIERS - FEATURES

180/185/186 Series Single Reduction Axles

380 Series Double Reduction Axles

AXLE MODELS		CARRIERS	INTER-AXLE DIFF.	MAIN DIFF. LOCK	NO SPIN® DIFF.	OIL PUMP	CARRIER PARTS CHART NUMBER
RS-23-180/185/186	Single Axles (single reduction)	A1-3200-J-1752 (1)					2
RS-26-180/185 RS-30-180/185		A-3200-J-1752 (1)		X			2
RS-23-380 RS-26-380 RS-30-380	Single Axles (double reduction) 2.35 - 46 axle spline	A17-3200-M-1833					1
RS-38-380	Single Axles (double reduction) 2.56 - 50 axle spline	A58-3200-M-1833			X		1
		A12-3200-M-1833					1
RT-48-180/185 RT-52-180/185 RT-58-180/185	Forward	RP-24-180/185 RP-26-180/185 RP-29-180/185	A84-3200-M-1833 A74-3200-M-1833	X X		X X	1 1
	Rear	RR-24-180 RR-26-180/185 RR-29-180/185	A1-3200-J-1752 (1) A-3200-J-1752 (1)				2 2
					X		
RT-48-380 RT-52-380 RT-58-380	Forward	RP-24-380 RP-26-380 RP-29-380	A76-3200-M-1833	X			X 1
	Rear	RR-24-380 RR-26-380 RR-29-380	A17-3200-M-1833 A36-3200-M-1833				
						X	1
RT-70-380	Forward	RP-35-380 RN-35-380	A73-3200-M-1833 A97-3200-M-1833	X			X 1
							1
	Rear	RR-35-380	A58-3200-M-1833 A12-3200-M-1833			X	1 1

NOTE: All carriers are less yoke.

@NoSPIN is a registered trademark of Tractech, a division of Dyneer Corp.

(1) These are 185/186 carriers and require KIT 4744 (carrier to axle housing fasteners) if replacing an 1804 or 1899 carrier with the 1752 or 1753 carrier.

TABLE OF CONTENTS

FORWARD CARRIERS OF ALL TANDEM AXLES & REAR CARRIERS OF 380 SERIES (DOUBLE REDUCTION) AXLES.....	1
CARRIERS FOR 180/185/186 SERIES SINGLE AXLES & REARS OF 180/185/186 SERIES TANDEM AXLES	8
OUTPUT (THRU) SHAFT ASSEMBLY PARTS.....	16
HOUSING ASSEMBLY PARTS	17
AXLE SHAFT SETS FOR 180/185/186/380 SERIES AXLES	19
AXLE SHAFTS	21
ROUND BEARING TYPE YOKES	24
EASY SERVICE (STRAP) TYPE YOKES.....	25
WING BEARING TYPE YOKES.....	26
COMPANION FLANGES.....	27
AXLE MODEL TO CARRIER KIT CROSS REFERENCE	28
SERVICE KITS	32
NUMERICAL PARTS LISTING	53

CHART 1
FORWARD CARRIERS OF ALL TANDEM AXLES
REAR CARRIERS OF 380 SERIES (DOUBLE-REDUCTION) AXLES
 (Use with Figures 1 and 1A)

VISUAL IDENTIFICATION OF CARRIERS		
		
<p style="text-align: center;">FORWARD CARRIER WITH IAD AND OIL PUMP</p> <p>A42-3200-M-1625 A58-3200-M-1625 A60-3200-M-1625 A63-3200-M-1625 A11-3200-M-1833 A13-3200-M-1833 A15-3200-M-1833 A73-3200-M-1833 A74-3200-M-1833 A76-3200-M-1833 A84-3200-M-1833</p>	<p style="text-align: center;">FORWARD CARRIER WITHOUT IAD OR OIL PUMP</p> <p>A59-3200-M-1625 A66-3200-M-1625 B8-3200-M-1625 B24-3200-M-1625 A12-3200-M-1833 A13-3200-M-1833 A31-3200-M-1833</p>	<p style="text-align: center;">REAR CARRIER WITH OIL PUMP</p> <p>A83-3200-M-1625 A36-3200-M-1833</p>
	<p style="text-align: center;">REAR CARRIER WITHOUT OIL PUMP</p> <p>A53-3200-M-1625 A58-3200-M-1833</p>	

FORWARD CARRIERS OF ALL TANDEM AXLES REAR CARRIERS OF 380 SERIES (DOUBLE-REDUCTION) AXLES

ITEM	DESCRIPTION		REMARKS	CARRIER	QTY	PART NUMBER
NOTE: ITEMS 1-42 ARE COMMON TO FWD 180 & 380 AND REAR 380						
1	Capscrew - lock plate			All	4	S-256A-2
2	Washer - lock plate			All	4	1229-E-1669
3	Lock Plate - adjusting ring			All	2	1220-S-1085
4	Adjusting rings - differential bearing		RH	All	1	2214-M-91
			LH			2214-K-89
5	Cups - differential bearing		RH - current	All	1	52618P
			RH - old style			KIT 4446 (1)
			LH			KIT 4445 (1)
6	Cones - differential bearing		RH - current	All	1	52387P
			RH - old style			KIT 4446 (1)
			LH			KIT 4445 (1)
7	Nut - main differential case			All	12	1227-M-1339
8	Washer - main differential case			All	12	1229-W-1557
9	Nut - gear to differential case		Incl. in KIT 2342	All	16	1227-N-1340
10	Washer - gear to differential case			All	16	1229-U-1555
11	Bolt - gear to differential case			All	16	15-X-1700
12, 7, 8, 19	Case assembly - main differential	Sgl. reduction 3.73 Sgl. reduction 4.10 Sgl. reduction 4.30		DbL. reduction 5.52 DbL. reduction 6.07 DbL. reduction 6.37	All	1
		Sgl. reduction 4.56 Sgl. reduction 4.89 Sgl. reduction 5.29 Sgl. reduction 5.38 Sgl. reduction 6.14 Sgl. reduction 6.83 Sgl. reduction 7.17	DbL. reduction 6.75 DbL. reduction 7.24 DbL. reduction 7.83 DbL. reduction 7.96 DbL. reduction 9.14 DbL. reduction 10.12 DbL. reduction 10.62	A-3235-U-1945		
12, 7, 8, 14, 15, 16, 17, 18, 19	Case & nest assy - main differential	Sgl. reduction 3.73 Sgl. reduction 4.10 Sgl. reduction 4.30	DbL. reduction 5.52 DbL. reduction 6.07 DbL. reduction 6.37	All others	1	A6-3235-T-1944
				RT-70-380		A7-3235-T-1944
		Sgl. reduction 4.56 Sgl. reduction 4.89 Sgl. reduction 5.29 Sgl. reduction 5.38 Sgl. reduction 6.14 Sgl. reduction 6.83 Sgl. reduction 7.17	DbL. reduction 6.75 DbL. reduction 7.24 DbL. reduction 7.83 DbL. reduction 7.96 DbL. reduction 9.14 DbL. reduction 10.12 DbL. reduction 10.62	All others		A6-3235-U-1945
				RT-70-380		A7-3235-U-1945
12, 7, 8, 15A, 19	Case & NoSPIN assy - main differential	Sgl. reduction 3.73 Sgl. reduction 4.10 Sgl. reduction 4.30	DbL. reduction 5.52 DbL. reduction 6.07 DbL. reduction 6.37	All others	1	A5-3235-T-1944
				RT-70-380		A3-3235-T-1944
				2-1/2" -50 spline		

(1) Update kit

FORWARD CARRIERS OF ALL TANDEM AXLES REAR CARRIERS OF 380 SERIES (DOUBLE-REDUCTION) AXLES

ITEM	DESCRIPTION		REMARKS	CARRIER	QTY	PART NUMBER
12, 7, 8, 15A, 19	Case & NoSPIN assy - main differential	Sgl. reduction 4.56	DbL. reduction 6.75	All others	1	A5-3235-U-1945
		Sgl. reduction 4.89	DbL. reduction 7.24	RT-70-380		A3-3235-U-1945
		Sgl. reduction 5.29	DbL. reduction 7.83	2-1/2" -50 spline		
		Sgl. reduction 5.38	DbL. reduction 7.96			
		Sgl. reduction 6.14	DbL. reduction 9.14			
		Sgl. reduction 6.83	DbL. reduction 10.12			
		Sgl. reduction 7.17	DbL. reduction 10.62			
13, 42	Drive gear, pinion & nut assembly	Sgl. reduction 3.73	DbL. reduction 5.52	All	1	B-40352-4
		Sgl. reduction 4.10	DbL. reduction 6.07			B-40354-4
		Sgl. reduction 4.30	DbL. reduction 6.37			B-40356-4
		Sgl. reduction 4.56	DbL. reduction 6.75			B-40358-4
		Sgl. reduction 4.89	DbL. reduction 7.24			B-40360-4
		Sgl. reduction 5.29	DbL. reduction 7.83			B-40312-4
		Sgl. reduction 5.38	DbL. reduction 7.96			B-40362-4
		Sgl. reduction 6.14	DbL. reduction 9.14			B-40364-4
		Sgl. reduction 6.83	DbL. reduction 10.12			B-40366-4
		Sgl. reduction 7.17	DbL. reduction 10.62			B-40368-4
14	Thrust washer - side gear			All	2	1229-L-3002
15	Side gear - differential		2.35" -46 spline		2	2234-C-1069
			2.56" -50 spline			2234-G-1229
15A	NoSPIN assembly		2.35" -46 spline		1	A-3230-E-1045
			2.56" -50 spline			A-3230-N-1028
16	Thrust washer - differential pinion			All	4	1229-D-992
17	Gear - differential pinion			All	4	2233-T-1112
18	Spider (cross) - differential			All	1	3278-Q-381
19	Bolt - main differential case		Long	Pre 4/02	8	15-X-1699
			Short			4
				After 4/02	12	15-X-1699 (2)
20, 29, 30	Differential carrier & cap assembly		One pc. bearing assy.	All	1	A2-3200-M-1833
			Two pc. bearing assy.			A2-3200-M-1625
21	Dowel - helical gear cover to carrier			All	2	1246-M-455
22	Plug - oil filter			All	1	P-112
23	Screen assembly - oil filter			All	1	A-1199-Z-3328
24	Capscrew - carrier to housing		Ref. only - not incl. with carrier. See housing section for exploded view of housing.		9	S-21016-2
25	Washer - carrier to housing				14	1229-U-1503
26	Nut - carrier to housing stud				5	N-110-1
27	Nut - thrust screw jam			All	1	1227-D-472
28	Screw - drive gear thrust			All	1	15-X-1167
29	Washer - differential bearing cap			All	4	1229-M-1625
30	Capscrew - differential bearing cap			All	4	S-11440-2
31	Snap ring - spigot bearing	One piece bearing	All other ratios		1	1229-L-1624
			Sgl. reduction 6.83	DbL. reduction 10.12		1229-K-1623
		Sgl. reduction 7.17	DbL. reduction 10.62			
	Two piece bearing					1229-T-4076

(2) Plain half in diff. case changed from 3235-U-1971 to 3235-C-2395.

FORWARD CARRIERS OF ALL TANDEM AXLES REAR CARRIERS OF 380 SERIES (DOUBLE-REDUCTION) AXLES

ITEM	DESCRIPTION		REMARKS	CARRIER	QTY	PART NUMBER
32, 31	Bearing - drive pinion spigot (inner & outer race plus snap ring)	Current design one piece bearing	All other ratios		1	1228-S-1267
			Sgl. reduction 6.83 Sgl. reduction 7.17	Dbl. reduction 10.12 Dbl. reduction 10.62		1228-A-261
		Old design two pc. brg. Incl. Item 31 (1229-T-4076 snap ring).	All other ratios			A5-1228-R-1266
			Sgl. reduction 6.83 Sgl. reduction 7.17	Dbl. reduction 10.12 Dbl. reduction 10.62		A4-1228-R-1266
33	Cones - drive pinion inner & outer bearing			All	2	78250AC
34	Cups - drive pinion inner & outer bearing			All	2	78551
35	Spacers - pinion bearing	.326" /8.28mm	Incl. in KITS 1554, RP180 1625, RP380 & RR380	All	Use 2 as req.	2203-U-7899
		.327" /8.31mm				2203-V-7900
		.328" /8.31mm				2203-W-7901
		.329" /8.33mm				2203-X-7902
		.330" /8.38mm				2203-Y-7903
		.331" /8.41mm				2203-Z-7904
		.332" /8.43mm				2203-A-7905
		.338" /8.59mm				2203-B-7906
		.345" /8.76mm				2203-C-7907
		.352" /8.94mm				2203-D-7908
		.359" /9.12mm				2203-E-7909
36	Shims - pinion bearing cage	.003" /0.075mm	Incl. in KITS 2432, RP180 1625, RP380 & RR830	All	Use as req.	2203-Z-6604
		.005" /0.125mm				2203-A-6605
		.010" /0.254mm				2203-B-6606
37, 34	Pinion bearing cage & cups assembly			All	1	A-3226-Z-598
38	Washer - pinion bearing cage			All	9	1229-C-1511
39	Capscrew - pinion bearing cage			All	9	10-X-1669
40	Gear - helical driven	forward-rear		RP-xx-180 carriers	1	3892-J-4014
				RP-xx-380 carriers		3892-B-4708
		forward-rear .756 overdrive	RP-180/380	3892-S-4023		
		single axles & rear-rear double reduction	RR & RS-xx-380	3892-D-4710		
41	Washer - drive pinion			All	1	1229-K-2429
42	Nut - drive pinion		Incl. in KITS RR380, RP380 & RP180 1625	All	1	1227-P-900
NOTE: ITEMS 43-98 ARE USED ONLY IN FWD. CARRIERS WITH IAD & WITH OIL PUMP (180 & 380)						
43	Cup - rear side gear bearing		Incl. in KITS RR380, RP380 & RP180 1625	All	1	JM-515610
44	Cone - rear side gear bearing			All	1	JM-515649
45	Side gear - inter-axle differential rear			All	1	2234-F-890
46, 47, 48, 49	Case assembly - inter-axle differential			All	1	A1-3235-X-1532
46, 47, 48, 49, 50, 51, 52	Case & nest assembly - inter-axle differential			All	1	A-3235-X-1532

FORWARD CARRIERS OF ALL TANDEM AXLES REAR CARRIERS OF 380 SERIES (DOUBLE-REDUCTION) AXLES

ITEM	DESCRIPTION		REMARKS	CARRIER	QTY	PART NUMBER
47	Bolt - inter-axle differential case			All	8	S-2626-2
48	Washer - inter-axle differential case			All	16	1229-K-1597
49	Nut - inter-axle differential case			All	8	NL-26-1
50	Thrust washer - inter-axle pinion		Incl. in KITS 2421, 2422,	All	4	1229-Q-2929
51	Gear - inter-axle pinion		RP180 1625 & RP380	All	4	2233-K-245
52	Spider (cross) - inter-axle differential			All	1	3278-N-300
53	Helical drive & forward side gear		forward-rear	RP-xx-180 carriers	1	3892-W-4963
				RP-xx-380 carriers		3892-Y-4965
			forward-rear .756 overdrive	RP-180/380		3892-M-5213
54	Thrust washer - helical drive gear		Incl. in KITS 2421, 2422, RP180 1625 & RP380	All	1	1229-L-2742
55	Input shaft, nut, ball & pin assembly			All after 11/93	1	A1-3297-N-1288
				All prior to 11/93		A1-3297-K-115
56	Roll pin - shift fork			All after 11/93	1	Not used
				All prior to 11/93		KIT 2268
57	Shift fork - inter-axle differential			All after 11/93	1	3296-Q-1187
				All prior to 11/93		3296-L-90
58	Clutch collar - inter-axle differential			All	1	3107-P-16
59	Adjusting screw - shift shaft			All	1	S-2812-2
60	Jam nut - adjusting screw			All	1	N-68-1
61	Cone - input shaft bearing		Incl. in KITS 4440,	All	1	HM-813844
62	Cup - input shaft bearing		RP180 1625 & RP380	All	1	HM-813810
63	Shims - input shaft bearing cage	.003" / .076mm	Incl. in KIT 1573 & 2432	All prior to 11/93	Use as req.	2203-C-6607
			Incl. in KIT 2885 & 2886	All after 11/93		2203-K-9241
		.005" / .127mm	Incl. in KIT 1573 & 2432	All prior to 11/93		2203-D-6608
			Incl. in KIT 2885 & 2886	All after 11/93		2203-L-9242
		.010" / .254mm	Incl. in KIT 1573 & 2432	All prior to 11/93		2203-E-6609
			Incl. in KIT 2885 & 2886	All after 11/93		2203-M-9243
64, 62	Bearing cage & cup assembly - input			All after 11/93	1	A-3226-H-1126
				All prior to 11/93		A-3226-J-790
64A	Pressure relief valve - oil			All after to 11/93	1	2297-U-5273
				All prior to 11/93		0
64B	Spring - oil pressure relief valve			All after 11/93	1	2258-Z-1118
				All prior to 11/93		0
64C	Washer - plug			11/93 thru 5/97	1	1229-F-4062
				All prior to 11/93 & after 5/97		0
64D	Pressure relief plug			11/93 thru 5/97	1	1250-N-1080
				All prior to 11/93 & after 5/97		0
65	Washer - input bearing cage			All after 11/93	7	1229-C-1511
				All prior to 11/93		6

FORWARD CARRIERS OF ALL TANDEM AXLES REAR CARRIERS OF 380 (DOUBLE-REDUCTION) AXLES

ITEM	DESCRIPTION	REMARKS	CARRIER	QTY	PART NUMBER
66	Capscrew - input bearing cage		All after 11/93	7	S-2814-A2
			All prior to 11/93	6	10-X-1669
67	Oil seal - input bearing cage		RP-180/380	1	A1-205-X2728
68	Deflector - input yoke	Available separately or as an assembly.	All	1	See Yoke Charts starting on page 24
69	Yoke & deflector assembly - input		All	1	
70	Washer - input yoke & shaft		All	1	1229-N-1730
71	Nut - input yoke & shaft	Incl. in KITS RP180 1625 & RP380	All	1	1227-D-940
72	Cover assembly - helical gear	Direct drive (1:1) & Reduction (1.48:1)	All after 11/93	1	3266-M-1313
		Overdrive (.756:1)			3266-Q-1317
		Updates to current design direct drive (1:1) & Reduction (1.48:1)	All prior to 11/93		KIT 2678
		Updates to current design overdrive (.756:1)			KIT 2679
73	Washer - gear cover to carrier		All	14	1229-C-1511
74	Capscrew - gear cover to carrier		All	14	S-2812-2
75	Spring - shift shaft return		All	1	2258-U-411
76	Shift shaft - inter-axle differential		All after 11/93	1	2244-K-1025
			All prior to 11/93		2297-X-2494
77	Shift assembly - inter-axle differential air		All after 11/93	1	A2-3261-Q-1057
			All prior to 11/93		KIT 2266
78	Capscrew - air shift assembly		All after 11/93	0	Not used
			All prior to 11/93	4	10-X-1334
79	Capscrew - filter shield		All after 11/93	0	Not used
			All prior to 11/93	2	S-256P-2
80	Washer - filter shield		All after 11/93	0	Not used
			All prior to 11/93	2	1229-E-1669
81	Shield - oil filter		All after 11/93	1	3280-Z-8398
			All prior to 11/93		A-3280-F-8430
82	Filter - oil		All after 11/93	1	3280-V-8394
			All prior to 11/93		3280-V-5040
83	Capscrew - oil pump	Long	All prior to 11/93	1	S-2616-2
		Short		6	S-2610-2
					MS-208045-1
84	Washer - oil pump		All after 11/93	6	1229-E-1669
			All prior to 11/93	7	1229-K-1597
85	Oil pump assembly	forward-rear	All after 11/93	1	A-3303-P-1030
			All prior to 11/93		A1-3303-L-12
85A	O-ring - pump assembly		All after 11/93	2	5-X-1034
			All prior to 11/93	0	Not used
86	Gear - pump driven		All after 11/93	0	Not used
			All prior to 11/93	1	3892-V-4936

FORWARD CARRIERS OF ALL TANDEM AXLES REAR CARRIERS OF 380 SERIES (DOUBLE-REDUCTION) AXLES

ITEM	DESCRIPTION	REMARKS	CARRIER	QTY	PART NUMBER
87	Capscrew - filter adapter		All after 11/93	0	Not used
			All prior to 11/93	2	S-2510-2
88	Washer - filter adapter		All after 11/93	0	Not used
			All prior to 11/93	2	1229-E-1669
89	Adapter - oil filter		All after 11/93	1	2297-Z-5278
			All prior to 11/93		2297-E-2293
90	Plug - gear cover		All after 11/93	0	Not used
			All prior to 11/93	1	P-16
91	O-ring - oil tube to gear cover		All after 11/93	0	Not used
			All prior to 11/93	1	3780-R-382
92	Tube - gear cover oil		All after 11/93	1	A-2297-D-5334
			All prior to 11/93		3196-B-28
93	Pin - oil restriction (not shown)		All after 11/93	0	Not used
			All prior to 11/93	1	1246-Q-615
94	Nut - pump idler shaft		All after 11/93	0	Not used
			All prior to 11/93	1	NL-210-1
95	Bearing assembly - pump idler gear		All after 11/93	0	Not used
			All prior to 11/93	1	A-1228-Z-572
96	Shaft - pump idler gear		All after 11/93	0	Not used
			All prior to 11/93	1	2297-L-5420
97	Gear - pump idler drive		All after 11/93	0	Not used
			All prior to 11/93	1	3892-W-4937
98	Washer - pump idler shaft		All after 11/93	0	Not used
			All prior to 11/93	1	1829-J-738
NOTE: ITEMS 99-115 ARE USED ONLY IN FWD. CARRIERS W/O IAD OR OIL PUMP AND IN THE REAR CARRIER OF 380 SERIES (DOUBLE REDUCTION) AXLES					
99, 115	Input shaft & nut assembly	forward-rear	RN-xx-380 carriers	1	A-3297-M-117
		rear-rear	RR-xx-380 carriers		A-3297-S-97
100	Cones - input shaft bearing	Inner	All	1	29685
		Outer			496
101	Cups - input shaft bearing	Inner	All	1	29620
		Outer			493
102	Oil scoop - helical gear cover		All	1	3221-H-8
103, 101, 102	Cover assembly - helical gear		All except rear-rear with pump	1	A1-3266-B-834
103, 101, 102, 116, 117, 118, 119, 120, 127, 128, 129	Cover assembly - helical gear		RR-xx-380 carrier (rear-rear) with oil pump	1	A-3266-L-792
104	Washer - gear cover to carrier		All	14	1229-C-1511

FORWARD CARRIERS OF ALL TANDEM AXLES REAR CARRIERS OF 380 SERIES (DOUBLE-REDUCTION) AXLES

ITEM	DESCRIPTION		REMARKS	CARRIER	QTY	PART NUMBER
105	Capscrew - gear cover to carrier			All	14	S-2812-2
106	Spacers - input shaft bearing	.326" /8.28mm	Incl. in KIT 1554	All	Use 2 as req.	2203-U-7899
		.327" /8.31mm				2203-V-7900
		.328" /8.33mm				2203-X-7902
		.329" /8.36mm				2203-W-7901
		.330" /8.38mm				2203-Y-7903
		.331" /8.41mm				2203-Z-7904
		.332" /8.43mm				2203-A-7905
		.338" /8.59mm				2203-B-7906
		.345" /8.76mm				2203-C-7907
		.352" /8.94mm				2203-D-7908
.359" /9.12mm	2203-E-7909					
107	Gear - helical drive			All	1	3892-F-4712
108	Cover - input		forward-rear	RN-180/380 carriers	1	A-3266-Y-831
			rear-rear	RR-xx-380 carriers		A-3266-P-1446
109	Washer - input cover			All	9	1229-K-1597
110	Capscrew - input cover			All	9	S-2610-2
111	Oil seal - input cover		forward-rear	RN-180/380 carriers	1	A1-1205-X-2728
			rear-rear	RR-xx-380 carriers		R945008
112	Deflector - input yoke		Available separately or	All	1	See Yoke Charts starting on page 24
113	Yoke & deflector assembly - input		as an assembly.	All	1	
114	Washer - input yoke & shaft		forward-rear	RN-180/380 carriers	1	1229-N-1730
			rear-rear	RR-xx-380 carriers		1229-T-1736
115	Nut - input yoke & shaft		forward-rear	RN-180/380 carriers	1	1227-D-940
			rear-rear	RR-xx-380 carriers		1227-J-946
NOTE: ITEMS 116-129 ARE OIL PUMP COMPONENTS THAT ARE ONLY USED IN REAR CARRIERS						
116	Tube - finished steel 11.88" long		3/8" OD x .032" wall		1	3196-U-21
117	Hose clamp				4	2257-S-1033
118	Hose 3/8" x 2"				1	2296-F-1098
119	Tube - finished steel .94" radius		3/8" OD x .032" wall		1	2296-B-106
120	O-ring				1	9680368
121	Button - pump drive				1	2297-C-3799
122	Washer - oil pump bolt		11/32" ID x 5/8" OD		3	1229-E-1669
123	Bolt - oil pump		5/16" dia. x 2.24" long		3	S-2518-2
124	Bolt - oil pump		3/8" dia. x 2.25" long		1	S-2616-2
125	Washer - oil pump bolt		13/32" ID x 13/16" OD		1	1229-B-1666
126	Oil pump assembly			rear carriers only	1	A-3303-M-13
127	Tube - finished steel .125" radius		7/16" OD x .032" wall		1	3196-T-20
128	Hose - 7/16" x 2"				1	2296-G-1099
129	Tube - finished steel 2" long		7/16" OD x .032" wall		1	2296-A-105

CHART 2
CARRIERS FOR 180/185/186 SERIES SINGLE AXLES AND
REARS OF 180/185/186 SERIES TANDEM AXLES
 (Use with Figure 2)

VISUAL IDENTIFICATION OF CARRIERS	
	
<p style="text-align: center;">REAR CARRIER WITHOUT DIFF. LOCK</p> <ul style="list-style-type: none"> A5-3200-C-1381 (ALUMINUM) A61-3200-U-1399 (MALLEABLE) A1-3200-K-1752 * A1-3200-K-1753 A1-3200-J-1804 A7-3200-J-1804 A6-3200-S-1839 * B8-3200-A-1899 (185/186 only) 	<p style="text-align: center;">REAR CARRIER WITH DIFF. LOCK</p> <ul style="list-style-type: none"> A6-3200-C-1381 (ALUMINUM) A54-3200-U-1399 (MALLEABLE) A1-3200-W-1791 A-3200-J-1752 * A-3200-K-1753 A1-3200-A-1899 B5-3200-A-1899 (185/186 only) B1-3200-L-1910 *

* These carriers are equipped with a thrust screw.

CARRIERS FOR 180/185/186 SERIES SINGLE AXLES & REARS OF 180/185/186 SERIES TANDEM AXLES

ITEM	DESCRIPTION		REMARKS	CARRIER	QTY	PART NUMBER
130	Nut - drive pinion		Incl. in KIT 2826	All	1	40-X-1233
130A	Washer - pinion nut			All	1	1229-N-1730
131	Input yoke assembly & deflector			All	1	See Yoke Charts starting on page 24
132	Deflector - input yoke			All	1	3264-P-172
133	Oil seal - pinion bearing cage assy.		Incl. in KIT 4435	All	1	A-1205-Q-2591
134	Cone - drive pinion outer bearing			All	1	H-715334
135	Cup - drive pinion outer bearing			All	1	H-715311
136	Capscrew - pinion bearing cage			1381	8	41-X-1043
				All others		MS-212045-1
137	Washer - pinion bearing cage			1899	8	1229-D-4632
				All others		MWA-512
138, 135, 141	Pinion bearing cage assembly			1752 & 1753	1	A-3226-V-1010
				All except 1752 & 1753		A-3226-B-860
139	Shims - pinion bearing cage	.003" / .075mm	Incl. in KIT 1592	All	Use as req.	2803-Y-2755
		.005" / .125mm				2803-Z-2756
		.008" / .200mm				2803-A-2757
		.020" / .500mm				2803-B-2758
140	Spacers - pinion bearing	.250" / 6.35mm	Incl. in KIT 1593	All	Use 2 as req.	2803-D-2500
		.251" / 6.38mm				2803-E-2501
		.252" / 6.40mm				2803-F-2502
		.254" / 6.45mm				2803-N-2510
		.256" / 6.50mm				2803-H-2504
		.260" / 6.60mm				2803-J-2506
		.261" / 6.63mm				2803-K-2507
		.262" / 6.65mm				2803-L-2508
		.263" / 6.68mm				2803-M-2509
		.264" / 6.70mm				2803-P-2512
141	Cup - drive pinion inner bearing		Incl. in KIT 4435	All	1	9220
142	Cone - drive pinion inner bearing			All	1	1228-V-594 (3)
143, 130	Drive gear, pinion & nut assembly	2.93 ratio	Use KIT 2608 bolt kit with these gearsets.	All 180/185/186 series rear-rear carriers (except 3.73-4.30 ratios in 1752 & 1753 carriers)	Use 1 as req.	B-41592-1
		3.07 ratio				B-41806-1
		3.21 ratio				B-41026-3
		3.42 ratio				B-41004-3
		3.58 ratio				B-41030-3
		3.73 ratio				B-41016-3
		3.91 ratio				B-41006-3
		4.10 ratio				B-41018-3
4.30 ratio	B-41014-3					

(3) Timken part no. 9278

CARRIERS FOR 180/185/186 SERIES SINGLE AXLES & REARS OF 180/185/186 SERIES TANDEM AXLES

ITEM	DESCRIPTION	REMARKS	CARRIER	QTY	PART NUMBER	
143, 130	Drive gear, pinion & nut assembly	4.56 ratio	Use KIT 2608 bolt kit with these gearsets.	All 180/185/186 series rear-rear carriers	Use 1 as req.	B-41008-3
		4.89 ratio				B-41034-3
		5.13 ratio				B-41010-3
		5.38 ratio				B-41028-3
		5.63 ratio				B-41032-3
		5.86 ratio				B-41012-3
		6.14 ratio				B-41036-3
		6.43 ratio				B-41024-4
		6.83 ratio				B-41022-1
		7.17 ratio				B-41020-1
		7.40 ratio				B-41002-1
7.83 ratio	B-41650-1					
143 & 130	Drive gear, pinion & nut assembly	3.07 ratio		1752 & 1753	Use 1 as req.	B-41806-1
		3.73 ratio				A-40636-1
		3.91 ratio				A-40638-1
		4.10 ratio				A-40632-1
		4.30 ratio				A-40634-1
144	Bearing - drive pinion spigot	6.83, 7.17, 7.40 & 7.83 ratios only	All	1		1228-A-261
		All other ratios				1228-S-1267
144A	Snap ring - drive pinion spigot bearing	6.83, 7.17, 7.40 & 7.83 ratios only		1		1229-K-1623
		All other ratios				1229-L-1624
145	Screw - thrust		1381	1		41-X-1020
			1752, 1839, 1910			15-X-1167
146	Nut - thrust screw jam		1381	1		40-X-1015
			1752, 1839, 1910			1227-D-472
147	Differential carrier & cap assembly	Aluminum		1		A2-3200-C-1381
		Less diff. lock (3.07-4.30 ratios)	Malleable (original design)			KIT 2732
		Less diff. lock (4.56-7.40 ratios)				KIT 2732A
		Malleable less diff. lock	180 & early 185/186 series			A2-3200-J-1804
		Malleable with diff. lock				A2-3200-A-1899S
		Malleable with or without diff. lock	Current 185/186 series			A2-3200-J-1752 (4)
		With diff. lock (3.07-4.30 ratios)	Malleable (original design)			A2-3200-K-1753
		With diff. lock (4.56-7.40 ratios)				KIT 2731
		KIT 2731A				
148	Washer - differential bearing cap		All	4		42-X-1024

(4) With set screw.

CARRIERS FOR 180/185/186 SERIES SINGLE AXLES & REARS OF 180/185/186 SERIES TANDEM AXLES

ITEM	DESCRIPTION		REMARKS	CARRIER	QTY	PART NUMBER
149	Capscrew - differential bearing cap			Aluminum carriers	4	41-X-1037
				Malleable carriers		41-X-1018
150	Plug		Magnetic	All	Use 1 as req.	45-X-1008
			Plain			45-X-1003
151	Adjusting ring		Left hand	1752 & 1753	1	2214-W-1011
			Left hand (small) 1804, 1899	All exc. 1752 & 1753		2214-G-1125
			Left hand (small) original design			2214-S-279
			Right hand	1752 & 1753		2214-X-1012
			Right hand (large) 1804, 1899	All exc. 1752 & 1753		2214-S-1137
			Right hand (large) original design			2214-Q-277
152	Cotter pin - adjusting ring left hand			All exc. 1752 & 1753	1	1199-R-2176
	Locking pin - adjusting ring			1752 & 1753		43-X-1015
153	Lock - adjusting ring right hand			All	1	1220-K-89
153A	Locking pin - adjusting ring			1752 & 1753	1	43-X-1015
	Locking pin - adjusting ring right hand			1899		1246-P-1134
154	Washer - adjusting ring lock			All	2	MWA-508
155	Capscrew - adjusting ring lock			All	2	MS-208020-1
156	Cover - special carrier				1	3266-M-897
156A	Plug			1899	1	1250-U-1217
157	Washer - cover			Items 156 thru 160 for 1381 & 1399 carriers without differential lock	4	MWA-506
158	Capscrew - cover				4	41-X-1080
159	Plug - special carrier capscrew				1	41-X-1022
160	Washer - plug				1	1229-U-1503
161	Cups - differential bearing	LH		1381, 1399, 1539, 1752 & 1753 only	1	JHM-720210
		RH		All others		KIT 2744
	1381, 1399, 1539, 1752 & 1753 only			64700		
	All others	JM-822010				

CARRIERS FOR 180/185/186 SERIES SINGLE AXLES & REARS OF 180/185/186 SERIES TANDEM AXLES

ITEM	DESCRIPTION		REMARKS	CARRIER	QTY	PART NUMBER
161A	Adhesive - bearing cap		Not shown. 2 tubes 5cc each. (One tube per bearing.)	All	1	2297-T-4180
162	Cones - differential bearing	LH		1381, 1399, 1539, 1752 & 1753 only	1	JHM-720249
				All others		KIT 2744
	RH	1381, 1399, 1539, 1752 & 1753 only		64450		
		All others		JM-822049		
163	Nut - differential case to gear			All	16	40-X-1182
164	Washer - plug			1899	16	1229-W-1557
				All others		1229-U-1503 (5)
165	Bolt - differential case to gear		Used in KIT 1594	All others (6)	16	41-X-1358
			Used in KIT 2608	1753, 1804, 1899		41-X-1334
166, 167, 168, 169, 170, 171, 172, 172A, 173	Differential case & nest assembly		2.93, 3.07, 3.21, 3.42, 3.58 ratios	1752 & 1753 with or without diff. lock (2.35" -46 spline)	1	A1-3235-Y-2339
				1752 & 1753 with or without diff. lock (2.56" -50 spline)		A2-3235-Y-2339
			2.93, 3.08, 3.21, 3.42, 3.58, 3.91, 4.10, 4.30 ratios	1381 & 1399		A5-3235-F-1618
				1791 & 1899 with diff. lock (2.35" -46 spline)		A3-3235-K-2143
				1791 & 1899 with diff. lock (2.56" -50 spline)		A7-3235-K-2143
				1804 less diff. lock (2.35" -46 spline)		A2-3235-K-2143
				1804 less diff. lock (2.56" -50 spline)		A5-3235-K-2143
				3.73, 3.91, 4.10, 4.30 ratios		1752 & 1753 with or without diff. lock (2.35" -46 spline)
				1752 & 1753 with or without diff. lock (2.56" -50 spline)		A2-3235-U-2335

(5) Can use 1229-W-1557 or MWA-516.

(6) Some 1399 carriers require KIT 2601 for chamfered ring gear mounting holes.

CARRIERS FOR 180/185/186 SERIES SINGLE AXLES & REARS OF 180/185/186 SERIES TANDEM AXLES

ITEM	DESCRIPTION	REMARKS	CARRIER	QTY	PART NUMBER
166, 167, 168, 169, 170, 171, 172, 172A, 173	Differential case & nest assembly	4.56, 4.89, 5.13, 5.38, 5.63, 5.86, 6.14, 6.43, 6.83, 7.17, 7.40, 7.83 ratios	1381 & 1399	1	A3-3235-H-1620
			1752 & 1753 with or without diff. lock (2.35" -46 spline)		A1-3235-W-2337
			1752 & 1753 with or without diff. lock (2.56" -50 spline)		A2-3235-W-2337
			1791 & 1899 with diff. lock (2.35" -46 spline)		A2-3235-M-2145
			1791 & 1899 with diff. lock (2.56" -50 spline)		A7-3235-M-2145
			1804 less diff. lock (2.35" -46 spline)		A3-3235-M-2145
			1804 less diff. lock (2.56" -50 spline)		A5-3235-M-2145
			166, 172, 172A, 173		Differential case assembly
1381 & 1399	A-3235-F-1618				
2.93, 3.08, 3.21, 3.42, 3.58, 3.91, 4.10, 4.30 ratios	1791 & 1899 with diff. lock	A1-3235-K-2143			
	1804 less diff. lock	A-3235-K-2143			
3.73, 3.91, 4.10, 4.30 ratios	1752 & 1753 with or without diff. lock	A-3235-U-2335			
4.56, 4.89, 5.13, 5.38, 5.63, 5.86, 6.14, 6.43, 6.83, 7.17, 7.40, 7.83 ratios	1381 & 1399	A-3235-H-1620			
	1752 & 1753 with or without diff. lock	A-3235-W-2337			
	1791 & 1899 with diff. lock	A-3235-M-2145			
	1804 less diff. lock	A1-3235-M-2145			
166, 172, 172A, 173, 173A	Differential case & NoSPIN assembly	2.93, 3.08, 3.21, 3.42, 3.58, 3.91, 4.10, 4.30 ratios	1381 & 1399	1	A6-3235-F-1618
			1804 less diff. lock (2.35" -46 spline)		A4-3235-K-2143
		4.56, 4.89, 5.13, 5.38, 5.63, 5.86, 6.14, 6.43, 6.83, 7.17, 7.40, 7.83 ratios	1381 & 1399		A5-3235-H-1620
			1804 less diff. lock (2.35" -46 spline)		A4-3235-M-2145
		1804 less diff. lock (2.56" -50 spline)	A6-3235-M-2145		
		167	Thrust washer - side gear		
168	Side gear - differential	Incl. in KIT 2318	2.35" -46 spline	2	2234-C-1069
		Incl. in KIT 2373	2.56" -50 spline	1	2234-P-1004
169	Thrust washer - differential pinion		All	4	1229-K-3001
170	Gear - differential pinion		All	4	2233-M-1001
171	Spider - differential		All	1	3278-W-335

CARRIERS FOR 180/185/186 SERIES SINGLE AXLES & REARS OF 180/185/186 SERIES TANDEM AXLES

ITEM	DESCRIPTION	REMARKS	CARRIER	QTY	PART NUMBER
172	Capscrew - differential case		All others	12	41-X-1275
			Thru-bolt design	4	41-X-1109
				8	41-X-1275
172A	Thread locking liquid	Use on Item 172	All	1	2297-C-7049
172B	Nut		1899	4	40-X-1182
173	Washer		1899	16	1229-W-1557
			All others	12	1229-U-1503
173A	NoSPIN Assembly		2.35" -46 spline	1	A-3230-C-1043
			2.56" -50 spline		A-3230-A-1041
NOTE: ITEMS 174-194 ARE FOR CARRIERS WITH DIFFERENTIAL LOCK					
174	Shift collar	2.35" -46 spline	1752 & 1753	1	3107-A-1041
			All others		3107-L-1104
		2.37" -46 spline	1381 & 1399		3107-Z-78
		2.56" -50 spline	1752 & 1753		3107-V-1010
			All others		3107-N-1106
175	Shift fork	One pc. style	1381, 1399, 1791	1	3296-N-1184
			1752 & 1753		3296-A-1197
			1899		3296-D-1174
176	Pin - shift fork	Used with 3 pc. style fork (3296-V-178)	1381 & 1399	2	43-X-1007
			All others		0
177	Spring - shift shaft		1899	1	2258-N-1262
			All others		2258-L-714
178	Shift shaft		1752 & 1753	1	2244-Z-52
			1899		2244-V-1114
			All others		2244-Y-51
179	Pin - shift shaft		1899	0	Not used
			All others		1
180	Washer - piston		1752, 1753 & 1899	0	Not used
			All others		1
181	Tube - air cylinder		1899	1	3261-A-1067
			All others		3196-F-32
182	Piston		1899	1	2230-T-1190
			All others		2230-N-170
183	O-ring		1899	1	5-X-1198
			All others		5-X-1153
184	Gasket - cylinder cover		1899	0	Not used
			All others		1
185	Capscrew - manual engaging (shipping)		1899	1	41-X-1368
			All others		41-X-1333
185A	O-ring		1899	1	5-X-521
186	Cover cylinder		1899	0	See Item 181
			All others		1

CARRIERS FOR 180/185/186 SERIES SINGLE AXLES & REARS OF 180/185/186 SERIES TANDEM AXLES

ITEM	DESCRIPTION	REMARKS	CARRIER	QTY	PART NUMBER
187	Capscrew - cylinder cover		1899	0	Not used
			All others	4	41-X-1364
188	Washer - cylinder cover		1899	0	Not used
			All others	4	MWA-506
189	Gasket - plug		1899	0	Not used
			All others	1	2208-L-1000
190	Plug - cylinder cover		1899	0	Not used
			All others	1	MS-210016-1
191	Switch - sensor		All	1	3237-W-1167
191A	Washer - sensor switch		1752 & 1753	2	1229-U-1503
192	Nut - sensor switch		1752, 1753 & 1899	0	Not used
			All others	1	1227-P-1056
193	Adaptor - cylinder cover	Converts old metric covers to use American standard threads.		1	No longer available
194	Gasket - adapter	Only used with Item 193		1	2208-L-1000
194A	Cover - cylinder hole		For carriers with DCDL bolt holes, but less DCDL	1	3266-M-897
194B	Capscrew - cylinder hole cover			4	41-X-1080
194C	Washer - cylinder hole cover			4	MWA-516

If you detect any **errors** in this catalog, please let us know.



We want the information to be as accurate as possible; we appreciate your help in making it so.

Please e-mail any comments/suggestions/corrections to us at: catalogfeedback@arvinmeritor.com

or mail to: ArvinMeritor
attn: Catalog Dept.
7975 Dixie Highway
Florence, KY 41042

OUTPUT (THRU) SHAFT ASSEMBLY PARTS



ITEM	DESCRIPTION	REMARKS	AXLE MODEL	QTY	PART NUMBER
195, 196, 198, 201, 202, 203, 204, 205, 206, 207	Output (thru) shaft, bearing cage and seal assembly		All	1	A1-3226-Q-901
196	Shaft - output (thru)		All	1	3297-W-75
197	Silastic gasket material (not shown)	Use as gasket for Item 198	All	1	2297-A-7021
198	Bearing cage & inner cup assembly	Includes one piece of Item 201	All	1	A-3226-Q-901
199	Washer - output bearing cage		All	6	1229-E-1513
200	Capscrew - output bearing cage		All others RT-70-380	6	S-2711-2 S-2710-2
201	Cups - inner & outer output bearing		All	2	382A
202	Cones - inner & outer output bearing		All	2	385A
203	Snap ring (spacer) output bearing	Incl. in KIT 1536	All	Use 1 as req.	1229-L-2430 1229-M-2431 1229-N-2432 1229-P-2434 1229-Q-2435 1229-R-2436 1229-S-2437 1229-T-2438 1229-U-2439
204	Snap ring spacer - output bearing yoke		All	1	1229-T-3062
205	Oil seal assembly		All	1	A-1205-C-1927
206	Washer - output yoke and shaft		All	1	1229-T-1736
207	Nut - output yoke and shaft		All	1	1227-J-946
209A	Breather assembly - housing		All	1	A-1199-W-4053

HOUSING ASSEMBLY PARTS



ITEM	DESCRIPTION	REMARKS	AXLE OR WHEEL END	QTY	PART NUMBER
208	Axle housing assembly		All	1	As specified
209	Breather assembly - housing		All	1	A-1199-R-4048
210	Stud - housing to carrier	All others	Total of five studs required	2	4-X-1051
		Single and tandem rears of 180/185/186 series axles		2	SN-1036-1
				1	SN-1020-1
				4	4-X-1929
211	Plug - heat indicator		All	1	P-28S
212	Plug - oil fill & drain		Magnetic	2	1250-E-473
			Standard		P-212
213	Washer - carrier to housing		All	14	1229-W-1557
214	Silastic gasket material		All	1	2297-A-7021
215	Capscrew - carrier to housing	All others	Incl. in KIT 2673	9	10-X-1595
		Single and tandem rears of 180/185/186 series axles		4	10-X-1596
				6	10-X-1601
		Single RS/RR185/186 using 1752 or 1753 carriers	Incl. in KIT 4744	4	10-X-1595
				2	10-X-1597
				4	10-X-1599

HOUSING ASSEMBLY PARTS

ITEM	DESCRIPTION	REMARKS	AXLE OR WHEEL END	QTY	PART NUMBER
216	Nut - carrier to housing	All others		5	N-110-1
		Single and tandem rears of 180/185/186 series axles		4	N-110-1
217	Wiper - housing spindle oil seal	Optional item. Use with standard oil seal	R	2	1199-B-1666
			U		1244-U-879
			W		2245-E-31
218	Oil seal assembly inner	Standard oil seal, use with Item 217	U	2	A-1205-Z-1820
			W		A-1205-S-1657
218A	Oil seal assembly	Unitized oil seal (wiper built in)	R	2	A-1205-R-2410
219	Cone - inner wheel bearing		R	2	598A
			U & W		782
220	Cup - inner wheel bearing		R	2	592A
			U & W		772
221	Cup - outer wheel bearing		R	2	572
			U		742
			W		6535
222	Cone - outer wheel bearing		R	2	580
			U		749
			W		6580
223	Nut - inner wheel bearing adjuster		R & U	2	1227-W-517
			W		1227-A-547
224	Lockwasher - adjuster nut		R & U	2	1229-F-4634S (7)
			W		1229-V-48
224A	Washer - tanged lock		R & U	2	1229-F-4634S (7)
225	Nut - outer wheel bearing (jam)		R & U	2	1227-R-330
			W		1227-F-448

MERITOR

an **ArvinMeritor** brand

(7) Includes 1 tanged washer and 1 lockwasher.

AXLE SHAFT SETS FOR 180/185/186/380 SERIES AXLES

LEFT HAND	RIGHT HAND
-----------	------------

RS-23-180/185/186 Single Axle

3202-W-7745	3202-H-8666
3202-W-7745	3202-Y-8111
3202-X-9098	3202-W-9097
3202-W-9149	3202-V-9148
3202-W-9149	3202-G-9159
3202-K-9267	3202-L-9372
3202-E-9391	3202-F-9392
3202-E-9391	3202-S-6779
3202-K-9579	3202-M-9581
3202-K-9579	3202-L-9580
3202-W-9643	3202-Y-9645

RS-23-380 Single Axle

3202-H-6768	3202-W-7745
3202-S-6779	3202-R-6778
3202-G-9497	3202-K-9501

RP-24-180/185 Forward of RT-48-180 Tandem

3202-H-6768	3202-W-7745
3202-S-6779	3202-R-6778
3202-F-9496	3202-E-9495

Rear of RT-48-180 Tandem

3202-Y-9125	3202-C-9129
3202-Y-9125	3202-J-9396
3202-J-9344	3202-L-9346
3202-J-9344	3202-J-9552
3202-L-9346	3202-J-9344
3202-G-9393	3202-B-8816
3202-G-9393	3202-G-9003

RP-24-380 Front of RT-48-380 Tandem

3202-S-6779	3202-R-6778
-------------	-------------

RR-24-380 Rear of RT-48-380 Tandem

3202-S-6779	3202-R-6778
-------------	-------------

RP-26-180/185 Front of RT-52-18X Tandem

3202-S-6779	3202-R-6778
3202-G-9497	3202-K-9501

LEFT HAND	RIGHT HAND
-----------	------------

RR-26-180/185 Rear of RT-52-18X Tandem

3202-H-9004	3202-N-9400
3202-G-9393	3202-B-8816
3202-G-9393	3202-G-9003

RS-26-180/185 Single Axle

3202-J-9344	3202-L-9346
3202-J-9344	3202-J-9552
3202-L-9346	3202-J-9344
3202-G-9393	3202-B-8816
3202-G-9393	3202-G-9003
3202-N-9400	3202-H-9004
3202-Q-9403	3202-H-9004

RS-26-181 Single Axle

3202-S-6779	3202-R-6778
-------------	-------------

RP-26-380 Forward of RT-52-380 Tandem

3202-S-6779	3202-R-6778
-------------	-------------

RR-26-380 Rear of RT-52-380 Tandem

3202-S-6779	3202-R-6778
-------------	-------------

RS-26-380 Single Axle

3202-H-6768	3202-W-7745
3202-S-6779	3202-R-6778

RP-29-180/185 Forward of RT-58-180 Tandem

3202-X-8110	3202-H-6768
3202-K-9501	3202-Z-8112
3202-L-9502	3202-G-9003
3202-L-9554	3202-X-8110

RR-29-180/185 Rear of RT-58-180 Tandem

3202-S-6779	3202-W-9409
3202-J-9370	3202-N-9374
3202-J-9370	3202-L-9372
3202-E-9391	3202-T-9458
3202-E-9391	3202-R-9456

RN-29-380 Forward of RT-58-380 Tandem
(less inter-axle diff.)

3202-L-9502	3202-G-9003
-------------	-------------

AXLE SHAFT SETS FOR 180/185/186/380 SERIES AXLES (cont.)

LEFT HAND	RIGHT HAND
-----------	------------

RP-29-380 Forward of RT-58-380 Tandem

3202-X-8110	3202-H-6768
3202-K-9501	3202-Z-8112
3202-L-9502	3202-G-9003
3202-L-9554	3202-X-8110

RR-29-380 Rear of RT-58-380 Tandem

3202-X-8110	3202-H-6768
3202-K-9501	3202-Z-8112
3202-L-9502	3202-G-9003

RS-30-180/185 Single Axle

3202-S-6779	3202-W-9409
3202-S-6779	3202-Y-9411
3202-J-9370	3202-N-9374
3202-J-9370	3202-L-9372
3202-E-9391	3202-T-9458
3202-E-9391	3202-R-9456

RS-30-181 Single Axle

3202-X-8110	3202-H-6768
3202-K-9501	3202-Z-8112

RS-30-380 Single Axle

3202-X-8110	3202-H-6768
3202-K-9501	3202-Z-8112
3202-L-9502	3202-G-9003

RP-35-180 Forward of RT-70-180 Tandem

3202-L-7734	3202-M-7735
3202-M-7787	3202-N-7788

RR-35-180 Rear of RT-70-180 Tandem

3202-D-9806	3202-C-9805
3206-U-1477	3206-T-1476

RN-35-380 Forward of RT-70-380 Tandem
(less inter-axle diff.)

3202-M-7787	3202-N-7788
3202-P-9142	3202-Q-9143
3202-R-9248	3202-S-9249

LEFT HAND	RIGHT HAND
-----------	------------

RP-35-380 Forward of RT-70-380 Tandem

3202-L-7734	3202-M-7735
3202-M-7787	3202-N-7788
3202-C-7803	3202-D-7804
3202-P-9142	3202-Q-9143
3202-P-9246	3202-Q-9247
3202-R-9248	3202-S-9249

RR-35-380 Rear of RT-70-380 Tandem

3202-L-7734	3202-M-7735
3202-M-7787	3202-N-7788
3202-C-7803	3202-D-7804
3202-P-9142	3202-Q-9143
3202-P-9246	3202-Q-9247
3202-R-9248	3202-S-9249

RS-38-380 Single Axle

3202-P-9142	3202-Q-9143
-------------	-------------

AXLE SHAFTS



PART NUMBER	BODY DIA.	LENGTH	LUBE HOLE	SPLINE SIZE	SPLINE LENGTH	FLANGE DIA.	NO. OF HOLES	HOLE SIZE	BOLT CIRCLE	HOLE TYPE
3202-J-9344	2.25"	36.57"	No	2.35" -46	3.03"	8.38"	8	.73"	7.00"	Taper
3202-Y-9125	2.25"	36.57"	No	2.35" -46	3.03"	8.38"	8	.78"	7.00"	Straight
3202-G-9393	2.25"	37.31"	No	2.35" -46	3.03"	8.38"	8	.73"	7.00"	Taper
3202-E-9391	2.25"	37.78"	No	2.35" -46	3.03"	8.38"	8	.73"	7.00"	Taper
3202-W-9643	2.25"	37.78"	Yes	2.35" -46	3.03"	8.38"	8	.73"	7.00"	Taper
3202-W-9149	2.25"	37.78"	No	2.35" -46	3.03"	8.38"	8	.78"	7.00"	Straight
3202-K-9579	2.25"	38.56"	No	2.35" -46	3.03"	8.38"	8	.64"	7.00"	Straight
3202-W-7745	2.25"	38.56"	No	2.35" -46	3.03"	8.38"	8	.73"	7.00"	Taper
3202-X-9098	2.25"	38.56"	Yes	2.35" -46	3.03"	8.38"	8	.73"	7.00"	Taper
3202-E-9495	2.25"	38.56"	No	2.35" -46	3.03"	8.38"	8	.78"	7.00"	Straight
3202-J-9370	2.25"	38.75"	No	2.35" -46	3.03"	8.38"	8	.73"	7.00"	Taper
3202-R-6778	2.25"	39.22"	No	2.35" -46	3.03"	8.38"	8	.73"	7.00"	Taper
3206-U-1477	2.25"	39.61"	Yes	2.55" -50	3.15"	8.50"	8	.73"	7.25"	Taper
3202-Z-8112	2.25"	39.96"	No	2.35" -46	3.03"	8.38"	8	.73"	7.00"	Taper
3202-H-9004	2.25"	40.31"	No	2.35" -46	3.03"	8.38"	8	.73"	7.00"	Taper
3202-F-9496	2.25"	41.03"	No	2.35" -46	3.03"	8.38"	8	.78"	7.00"	Straight
3202-H-6768	2.25"	41.06"	No	2.35" -46	3.03"	8.38"	8	.73"	7.00"	Taper
3202-K-9267	2.25"	41.37"	No	2.35" -46	3.03"	8.38"	8	.73"	7.00"	Taper
3202-M-7735	2.38"	41.71"	Yes	2.55" -50	3.15"	8.50"	8	.73"	7.25"	Taper
3202-S-6779	2.25"	41.72"	No	2.35" -46	3.03"	8.38"	8	.73"	7.00"	Taper
3202-G-9159	2.25"	41.72"	No	2.35" -46	3.03"	8.38"	8	.78"	7.00"	Straight
3202-Q-9143	2.25"	41.74"	Yes	2.55" -50	3.15"	8.50"	8	.73"	7.25"	Taper
3202-F-9392	2.25"	41.85"	No	2.35" -46	9.14"	8.38"	8	.73"	7.00"	Taper
3202-Y-9645	2.25"	41.85"	Yes	2.35" -46	9.14"	8.38"	8	.73"	7.00"	Taper
3202-V-9148	2.25"	41.85"	No	2.35" -46	9.14"	8.38"	8	.78"	7.00"	Straight
3202-K-9501	2.25"	42.30"	No	2.35" -46	3.03"	8.38"	8	.73"	7.00"	Taper
3202-L-9580	2.25"	42.56"	No	2.35" -46	3.03"	8.38"	8	.64"	7.00"	Straight
3202-Y-8111	2.25"	42.56"	No	2.35" -46	3.03"	8.38"	8	.73"	7.00"	Taper

AXLE SHAFTS



PART NUMBER	BODY DIA.	LENGTH	LUBE HOLE	SPLINE SIZE	SPLINE LENGTH	FLANGE DIA.	NO. OF HOLES	HOLE SIZE	BOLT CIRCLE	HOLE TYPE
3202-M-9581	2.25"	42.72"	No	2.35" -46	9.14"	8.38"	8	.64"	7.00"	Straight
3202-H-8666	2.25"	42.72"	No	2.35" -46	9.14"	8.38"	8	.73"	7.00"	Taper
3202-W-9097	2.25"	42.72"	Yes	2.35" -46	9.14"	8.38"	8	.73"	7.00"	Taper
3202-J-9552	2.25"	43.01"	No	2.35" -46	3.03"	8.38"	8	.73"	7.00"	Taper
3202-J-9396	2.25"	43.01"	No	2.35" -46	3.03"	8.38"	8	.78"	7.00"	Straight
3202-L-9346	2.25"	43.07"	No	2.35" -46	9.14"	8.38"	8	.73"	7.00"	Taper
3202-C-9129	2.25"	43.07"	No	2.35" -46	9.14"	8.38"	8	.78"	7.00"	Straight
3202-X-8110	2.25"	43.40"	No	2.35" -46	3.03"	8.38"	8	.73"	7.00"	Taper
3202-G-9003	2.25"	43.80"	No	2.35" -46	3.03"	8.38"	8	.73"	7.00"	Taper
3202-B-8816	2.25"	43.93"	No	2.35" -46	9.14"	8.38"	8	.73"	7.00"	Taper
3202-L-7734	2.38"	44.18"	Yes	2.55" -50	3.15"	8.50"	8	.73"	7.25"	Taper
3202-P-9142	2.38"	44.21"	Yes	2.55" -50	3.15"	8.50"	8	.73"	7.25"	Taper
3202-R-9456	2.25"	44.37"	No	2.35" -46	3.03"	8.38"	8	.73"	7.00"	Taper
3202-T-9458	2.25"	44.45"	No	2.35" -46	9.14"	8.38"	8	.73"	7.00"	Taper
3202-G-9497	2.25"	44.77"	No	2.35" -46	3.03"	8.38"	8	.73"	7.00"	Taper
3202-L-9372	2.25"	45.34"	No	2.35" -46	3.03"	8.38"	8	.73"	7.00"	Taper
3202-N-9374	2.25"	45.42"	No	2.35" -46	9.14"	8.38"	8	.73"	7.00"	Taper
3202-M-9269	2.25"	45.53"	No	2.35" -46	9.14"	8.38"	8	.73"	7.00"	Taper
3202-D-7804	2.25"	45.84"	Yes	2.35" -46	3.03"	8.38"	8	.73"	7.00"	Taper
3202-S-9249	2.25"	45.84"	Yes	2.55" -50	3.15"	8.50"	8	.73"	7.25"	Taper
3202-L-9554	2.25"	45.90"	No	2.35" -46	3.03"	8.38"	8	.73"	7.00"	Taper
3206-T-1476	2.25"	46.28"	Yes	2.55" -50	3.15"	8.50"	8	.73"	7.25"	Taper
3202-L-9502	2.25"	46.30"	No	2.35" -46	3.03"	8.38"	8	.73"	7.00"	Taper
3202-N-9400	2.25"	46.74"	No	2.35" -46	3.03"	8.38"	8	.73"	7.00"	Taper
3202-Q-9403	2.25"	46.90"	No	2.35" -46	9.14"	8.38"	8	.73"	7.00"	Taper
3202-C-7803	2.38"	48.31"	Yes	2.55" -50	3.15"	8.50"	8	.73"	7.25"	Taper
3202-R-9248	2.38"	48.31"	Yes	2.55" -50	3.15"	8.50"	8	.73"	7.25"	Taper
3202-W-9409	2.25"	48.31"	No	2.35" -46	3.03"	8.38"	8	.73"	7.00"	Taper

AXLE SHAFTS

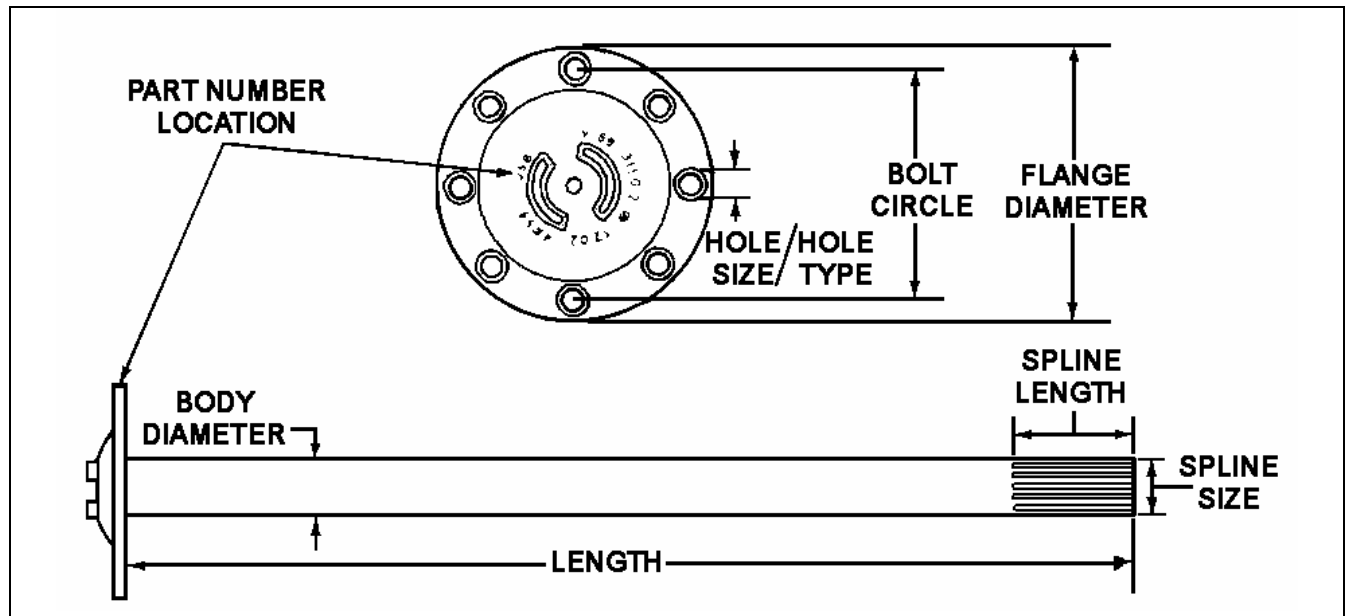

PART NUMBER	BODY DIA.	LENGTH	LUBE HOLE	SPLINE SIZE	SPLINE LENGTH	FLANGE DIA.	NO. OF HOLES	HOLE SIZE	BOLT CIRCLE	HOLE TYPE
3202-Y-9411	2.25"	48.39"	No	2.35" -46	9.14"	8.38"	8	.73"	7.00"	Taper
3202-D-9806	2.25"	51.63"	Yes	2.55" -50	3.15"	8.50"	8	.73"	7.25"	Taper
3202-N-7788	2.38"	53.72"	Yes	2.55" -50	3.15"	8.50"	8	.73"	7.25"	Taper
3202-Q-9247	2.38"	53.74"	Yes	2.55" -50	3.15"	8.50"	8	.73"	7.25"	Taper
3202-M-7787	2.38"	56.18"	Yes	2.55" -50	3.15"	8.50"	8	.73"	7.25"	Taper
3202-P-9246	2.38"	56.21"	Yes	2.55" -50	3.15"	8.50"	8	.73"	7.25"	Taper
3202-C-9805	2.25"	58.27"	Yes	2.55" -50	3.15"	8.50"	8	.73"	7.25"	Taper

XpresswayPlus.ArvinMeritor.com



XpresswayPlus.ArvinMeritor.com
For all of your parts-ordering needs

Don't forget about using *XpresswayPlus* for:

- Ordering parts online
- Order status
- Price and availability
- Invoice Lookup
- Parts Catalog
- Online e-mail or phone numbers for Customer Service, Information Services, Marketing, Catalog, and eSupport
- Reference Library
- The Company Store
- Literature
- Dealer/Distributor locator

XpresswayPlus is easy to use, can reduce phone calls, and save you valuable time.

ROUND BEARING TYPE YOKES



Axle Model (Location)	Center to End	Spline Length	Hub Dia.	Bearing Dia.	Across Ears	Spline Size Dia.-No. Teeth	Part Number	Production Part Number
Single Axle Input RS-23-180 RS-26-180 RS-30-180	5.50"	2.88"	3.25"	1.88"	5.31"	2.38" -46	16NYS38-11A	A-3260-Y-1143
	5.94"			1.94"	6.09"		17N-4-5961X	A1-3260-S-357
	5.94"			1.94"	6.09"		17N-4-6961X	A-3260-S-357
	6.19"			1.94"	6.09"		17NYS38-17A2	A2-3260-W-75
	6.93"			1.94"	6.09"		17N-4-7851X	A-3260-N-1314
	5.63"			1.94"	7.00"		176N-4-861X	A-3260-R-356
	5.69"			1.94"	7.55"		18N-4-3581X	A2-3260-U-73
Single Axle Input RS-23-380 RS-26-380 RS-38-380	5.16"	2.31"	3.00"	1.94"	6.09"	2.00" -39	17NYS32-100A2	A2-3260-G-1645
	6.25"				6.09"		17NYS32-99A3	---
	5.19"				7.55"		18NYS32-12A2	A2-3260-L-116
Fwd. Axle Input RT-48-180 RT-52-180 RT-58-180	5.94"	2.88"	3.25"	1.94"	6.09"	2.38" -46	17N-4-5961X	A1-3260-S-357
	5.63"				7.00"		176NYS38-13A1	A1-3260-R-356
	5.69"				7.55"		18N-4-3221X	A-3260-U-73
Fwd. Axle Output RT-48-380 RT-52-380 RT-58-380 RT-70-380	5.54"	2.31"	3.00"	1.88"	5.31"	2.00" -39	16N-4-6271	3260-G-111
	6.25"			1.94"	6.09"		17NYS32-99	---
	5.16"			1.94"	6.09"		17NYS32-100A	A3260-G-1645
	5.19"			1.94"	7.55"		18N-4-3371	3260-L-116
Rear Axle Input RT-48-180 RT-52-180 RT-58-180 RT-52-380 RT-48-380 RS-58-380 RT-70-380	5.50"	2.88"	3.25"	1.88"	5.31"	2.38" -46	16NYS38-11A	A-3260-Y-1143
	5.94"			1.94"	6.09"		17N-4-5961X	A1-3260-S-357
	5.94"			1.94"	6.09"		17N-4-6961X	A-3260-S-357
	6.19"			1.94"	6.09"		17NYS38-17A2	A2-3260-W-75
	6.93"			1.94"	6.09"		17N-4-7851X	A-3260-N-1314
	5.63"			1.94"	7.00"		176N-4-861X	A-3260-R-356
	5.69"			1.94"	7.55"		18N-4-3581X	A2-3260-U-73

EASY SERVICE (STRAP) TYPE YOKES



Axle Model (Location)	Center to End	Spline Length	Hub Dia.	Bearing Dia.	Distance Between Nibbs	Spline Size Dia.- No. Teeth	Hole Type	Part Number	Production Part Number		
Single Axle Input RS-23-180 RS-26-180 RS-30-180	5.50"	2.88"	3.25"	1.88"	5.31"	2.38" -46	TH	16TYS38-11A	A-3260-M-1235		
	5.94"			1.94"	6.19"		TH	17N-4-6961-1X	A-3260-B-1302		
	6.93"			1.94"	6.19"		TH	17TYS38-70A	A-3260-R-1682		
	5.63"			1.94"	7.09"		TH	176N-4-861-1X	A-3260-Q-1265		
	5.69"			1.94"	7.63"		TH	18N-4-3581-1X	A-3260-K-1259		
Single Axle Input RS-23-380 RS-26-380 RS-38-380	5.54"	2.31"	3.00"	1.88"	5.31"	2.00" -39	TH	16N-4-6271-1	3260-F-1280		
	5.16"			1.94"	6.19"		TH	17TYS32-68A2	A2-3260-R-1292		
	5.19"			1.94"	7.09"		TH	176TYS32-3A2	A2-3260-S-1267		
	5.19"			1.94"	7.63"		TH	18TYS32-12A2	A2-3260-N-1262		
Fwd. Axle Input RT-48-480 RT-52-180 RT-58-180 RT-52-380 RT-58-380 RT-70-380	5.94"	2.88"	3.25"	1.94"	6.19"	2.38" -46	TH	17TYS38-53A1	A1-3260-B-1302		
	5.63"			1.94"	7.09"		TH	176TYS38-13A1	A1-3260-Q-1265		
	5.69"			1.94"	7.63"		TH	18N-4-3221-1X	A1-3260-K-1259		
	5.54"	2.31"	3.00"	1.88"	5.31"	2.00" -39	TH	16N-4-6271-1	3260-F-1280		
	5.16"			1.94"	6.19"		TH	17N-4-7621-1	3260-R-1292		
	6.25"			1.94"	6.19"		TH	17TYS32-99	---		
	5.19"			1.94"	7.63"		TH	18N-4-3381-1X	A-3260-N-1262		
Fwd. Axle Output RT-48-180 RT-52-180 RT-58-180 RT-52-380 RT-58-380 RT-70-380	5.50"	2.88"	3.25"	1.88"	5.31"	2.38" -46	TH	16TYS38-11A	A-3260-M-1235		
	5.94"			1.94"	6.19"		TH	17N-4-6961-1X	A-3260-B-1302		
	6.93"			1.94"	6.19"		TH	17TYS38-70A	A-3260-R-1682		
	5.63"			1.94"	7.09"		TH	176N-4-861-1X	A-3260-Q-1265		
	5.69"			1.94"	7.63"		TH	18N-4-3581-1X	A-3260-K-1259		

WING BEARING TYPE YOKES



Axle Model (Location)	Face to End	Spline Length	Hub Dia.	Slot Width	Pilot Dia.	Spline Size Dia.- No. Teeth	Hole Type	Part Number	Production Part Number			
Single Axle Input												
RS-23-180	4.63"	2.88"	3.25"	.63"	8.13"	2.38" -46	TH	82NYS38-28A	A-3260-D-1148			
RS-26-180	4.19"				8.25"		TH		92NYS38-52A2	A2-3260-Q-95		
RS-30-180												
Single Axle Input												
RS-23-380	3.88"	2.31"	3.00"	.63"	8.13"	2.00" -39	TH	82NYS32-74A2	A2-3260-M-117			
RS-26-380												
RS-38-380												
Fwd. Axle Input	4.19"	2.88"	3.25"	.63"	8.25"	2.38" -46	TH	92NYS38-52A	A-3260-Q-95			
RT-48-180												
RT-52-180												
RT-58-180												
RT-48-380												
RT-52-380												
RT-58-380												
RT-70-380												
Fwd. Axle Output	3.88"	2.31"	3.00"	.63"	8.13"	2.00" -39	TH	82NYS32-74	3260-M-117			
Rear Axle Input												
RT-48-180	4.63"	2.88"	3.25"	.63"	8.13"	2.38" -46	TH	82NYS38-28A	A-3260-D-1148			
RT-52-180					8.25"		TH		92NYS38-52A2	A2-3260-Q-95		
RT-58-180	4.19"											
RT-48-380												
RT-52-380												
RT-58-380												
RT-70-380												

COMPANION FLANGES



Axle Model (Location)	Face to End	Hub Dia.	Spline Length	Pilot Dia. M=Male F=Female	Flange O.D.	Hole Dia.	Bolt Circle Dia.	Spline Size Dia.-No. Teeth	Part Number	Production Part Number
Single Axle Input RS-23-180 RS-26-180 RS-30-180	3.56"	3.25"	2.88"	F-7.75"	8.00"	.44"	7.25"	2.38"-46	5WCS38-12A2	A2-3260-U-151
	3.64"			F-7.75"					5WCS38-24A	A-3260-D-1252

If you detect any **errors** in this catalog, please let us know.



We want the information to be as accurate as possible; we appreciate your help in making it so.

Please e-mail any comments/suggestions/corrections to us at: catalogfeedback@arvinmeritor.com

or mail to: ArvinMeritor
attn: Catalog Dept.
7975 Dixie Highway
Florence, KY 41042

AXLE MODEL TO CARRIER TO KIT CROSS REFERENCE

AXLE MODEL	BASE CARRIER	KIT NUMBER	KIT DESCRIPTION
RS-23-180 RS-23-185 RS-23-186 RS-30-180 RS-30-185	Single Axle 3200-C-1381 3200-U-1399	KIT 1592	Pinion bearing cage shims
		KIT 1593	Pinion bearing spacer kit
		KIT 2318	Main differential nest with spider 2.35-46 spline
		KIT 2341	Main differential nest without spider 2.35-46 spline
		KIT 2363	Main differential lock kit
		KIT 2373	Main differential nest with spider 2.56-50 spline
		KIT 2374	Main differential nest without spider 2.56-50 spline
		KIT 4435	Bearing kit all except 6.83, 7.17, 7.40 & 7.83 ratios
		KIT 4436	Bearing kit, 6.83, 7.17, 7.40 & 7.83 ratios
		KIT RS23180	Major overhaul kit
	3200-W-1791 3200-A-1899	KIT 1592	Pinion bearing cage shims
		KIT 1593	Pinion bearing spacer kit
		KIT 2318	Main differential nest with spider 2.35-46 spline
		KIT 2341	Main differential nest without spider 2.35-46 spline
		KIT 2373	Main differential nest with spider 2.56-50 spline
		KIT 2374	Main differential nest without spider 2.56-50 spline
		KIT 2630	Main differential lock kit (except 1899 carrier)
		KIT 2699	Main differential lock kit (1899 carrier)
		KIT 4437	Bearing kit all except 6.83, 7.17, 7.40 & 7.83 ratios
		KIT 4438	Bearing kit, 6.83, 7.17, 7.40 & 7.83 ratios
	3200-J-1804	A2-3200-A-1899S	Carrier update
		KIT RS23180A	Major overhaul kit
		KIT 1592	Pinion bearing cage shims
		KIT 1593	Pinion bearing spacer kit
		KIT 2318	Main differential nest with spider 2.35-46 spline
		KIT 2341	Main differential nest without spider 2.35-46 spline
		KIT 2373	Main differential nest with spider 2.56-50 spline
		KIT 2374	Main differential nest without spider 2.56-50 spline
		KIT 4437	Bearing kit all except 6.83, 7.17, 7.40 & 7.83 ratios
		KIT 4438	Bearing kit, 6.83, 7.17, 7.40 & 7.83 ratios
	3200-J-1752 3200-K-1753	KIT RS23180A	Major overhaul kit
		KIT 1592	Pinion bearing cage shims
		KIT 1593	Pinion bearing spacer kit
		KIT 2318	Main differential nest with spider 2.35-46 spline
		KIT 2341	Main differential nest without spider 2.35-46 spline
		KIT 2373	Main differential nest with spider 2.56-50 spline
		KIT 2374	Main differential nest without spider 2.56-50 spline
		KIT 2791	Complete diff. lock retro-fit kit
		KIT 2792	Major diff. lock repair kit
		KIT 2793	Minor diff. lock repair kit
		KIT 4459	Bearing kit all except 6.83, 7.17, 7.40 & 7.83 ratios
KIT 4460	Bearing kit, 6.83, 7.17, 7.40 & 7.83 ratios		
KIT RR26185 1752	Overhaul kit 2.35-46 spline. Ratios 2.93-6.43		
KIT RR26185A 1752	Overhaul kit 2.35-46 spline. Ratios 6.83-7.83		

AXLE MODEL TO CARRIER TO KIT CROSS REFERENCE

AXLE MODEL		BASE CARRIER	KIT NUMBER	KIT DESCRIPTION	
RT-48-180	RP-24-180	3200-M-1625	KIT 1554	Pinion bearing spacer kit	
RT-52-180	RP-26-180		KIT 2421	IAD nest without case, with spider	
RT-52-185	RP-26-185		KIT 2432	Bearing cage shim kit (pre 11-93)	
RT-58-180	RP-29-180		KIT 2436	Main differential nest with spider 2.35-46 spline	
RT-58-185	RP-29-185		KIT 2484	Helical gear kit	
			KIT 2490	IAD nest without case, without spider	
			KIT 2678	Helical gear cover update	
			KIT 2885	Bearing cage shim kit (post 11-93)	
			KIT 4440	Bearing kit all ratios	
			KIT 4445	Bearing update kit - L.H.	
			KIT 4446	Bearing update kit - R.H.	
			KIT RP180 1625	Major overhaul kit	
			3200-M-1833	KIT 1554	Pinion bearing spacer kit
				KIT 2421	IAD nest without case, with spider
		KIT 2432		Bearing cage shim kit (pre 11-93)	
		KIT 2436		Main differential nest with spider 2.35-46 spline	
		KIT 2484		Helical gear kit	
		KIT 2490		IAD nest without case, without spider	
		KIT 2678		Helical gear cover update	
		KIT 2885		Bearing cage shim kit (post 11-93)	
		KIT 4441		Bearing kit all except 6.83, 7.17, 7.40 & 7.83 ratios	
		KIT 4442		Bearing kit, 6.83, 7.17, 7.40 & 7.83 ratios	
		KIT 4445		Bearing update kit - L.H.	
		KIT 4446		Bearing update kit - R.H.	
		KIT RP180 1833		Major overhaul kit	
RR-24-180		3200-C-1381		KIT 1592	Pinion bearing cage shims
RR-26-180		3200-U-1399	KIT 1593	Pinion bearing spacer kit	
RR-26-185			KIT 2318	Main differential nest with spider 2.35-46 spline	
RR-29-180			KIT 2341	Main differential nest without spider 2.35-46 spline	
RR-29-185			KIT 2363	Main differential lock kit	
			KIT 4435	Bearing kit all except 6.83, 7.17, 7.40 & 7.83 ratios	
			KIT 4436	Bearing kit, 6.83, 7.17, 7.40 & 7.83 ratios	
			KIT RS23180	Major overhaul kit	
			3200-W-1791 3200-A-1899	KIT 1592	Pinion bearing cage shims
		KIT 1593		Pinion bearing spacer kit	
		KIT 2318		Main differential nest with spider 2.35-46 spline	
		KIT 2341		Main differential nest without spider 2.35-46 spline	
		KIT 2630		Main differential lock kit (except 1899 carrier)	
		KIT 2699		Main differential lock kit (1899 carrier)	
		KIT 4437		Bearing kit all except 6.83, 7.17, 7.40 & 7.83 ratios	
		KIT 4438		Bearing kit, 6.83, 7.17, 7.40 & 7.83 ratios	
		A2-3200-A-1899S		Carrier update	
		KIT RS23180A		Major overhaul kit	
		3200-J-1804	KIT 1592	Pinion bearing cage shims	
			KIT 1593	Pinion bearing spacer kit	
			KIT 2318	Main differential nest with spider 2.35-46 spline	
			KIT 2341	Main differential nest without spider 2.35-46 spline	
			KIT 2373	Main differential nest with spider 2.56-50 spline	
			KIT 2374	Main differential nest without spider 2.56-50 spline	
			KIT 4437	Bearing kit all except 6.83, 7.17, 7.40 & 7.83 ratios	
			KIT 4438	Bearing kit, 6.83, 7.17, 7.40 & 7.83 ratios	
			KIT RS23180A	Major overhaul kit	

AXLE MODEL TO CARRIER TO KIT CROSS REFERENCE

AXLE MODEL		BASE CARRIER	KIT NUMBER	KIT DESCRIPTION	
RT-48-180	RR-24-180	3200-J-1752	KIT 1592	Pinion bearing cage shims	
RT-52-180	RR-26-180	3200-K-1753	KIT 1593	Pinion bearing spacer kit	
RT-52-185	RR-26-185		KIT 2318	Main differential nest with spider 2.35-46 spline	
RT-58-180	RR-29-180		KIT 2341	Main differential nest without spider 2.35-46 spline	
RT-58-185	RR-29-185		KIT 2373	Main differential nest with spider 2.56-50 spline	
(cont)	(cont)		KIT 2374	Main differential nest without spider 2.56-50 spline	
			KIT 2791	Complete diff. lock retro-fit kit	
			KIT 2792	Major diff. lock repair kit	
			KIT 2793	Minor diff. lock repair kit	
			KIT 4459	Bearing kit all except 6.83, 7.17, 7.40 & 7.83 ratios	
			KIT 4460	Bearing kit, 6.83, 7.17, 7.40 & 7.83 ratios	
			KIT RR26185 1752	Overhaul kit 2.35-46 spline. Ratios 2.93-6.43	
			KIT RR26185A 1752	Overhaul kit 2.35-46 spline. Ratios 6.83-7.83	
RT-48-380	RP-24-380		3200-M-1625	KIT 1554	Pinion bearing spacer kit
RT-52-380	RP-26-380			KIT 2422	IAD nest without case, with spider
RT-58-380	RP-29-380	KIT 2432		Bearing cage shim kit (pre 11-93)	
		KIT 2436		Main differential nest with spider 2.35-46 spline	
		KIT 2491		IAD nest without case, without spider	
		KIT 2678		Helical gear cover update	
		KIT 2885		Bearing cage shim kit (post 11-93)	
		KIT 4440		Bearing kit all ratios	
		KIT 4445		Bearing update kit - L.H.	
		KIT 4446		Bearing update kit - R.H.	
		KIT RP380		Major overhaul kit	
		MPS 3355		Helical gear kit	
		3200-M-1833		KIT 1554	Pinion bearing spacer kit
				KIT 2422	IAD nest without case, with spider
			KIT 2432	Bearing cage shim kit (pre 11-93)	
			KIT 2436	Main differential nest with spider 2.35-46 spline	
			KIT 2491	IAD nest without case, without spider	
			KIT 2678	Helical gear cover update	
			KIT 2885	Bearing cage shim kit (post 11-93)	
			KIT 4441	Bearing kit all except 6.83, 7.17, 7.40 & 7.83 ratios	
			KIT 4442	Bearing kit, 6.83, 7.17, 7.40 & 7.83 ratios	
			KIT 4445	Bearing update kit - L.H.	
			KIT 4446	Bearing update kit - R.H.	
			KIT RP380A	Major overhaul kit	
			MPS 3355	Helical gear kit	
			3200-M-1625	KIT 1554	Pinion bearing spacer kit
		KIT 2432		Bearing cage shim kit (pre 11-93)	
		KIT 2436		Main differential nest with spider 2.35-46 spline	
		KIT 2885		Bearing cage shim kit (post 11-93)	
		KIT 4450		Bearing kit all ratios	
		KIT 4445		Bearing update kit - L.H.	
		KIT 4446		Bearing update kit - R.H.	
		KIT RR380		Major overhaul kit	

AXLE MODEL TO CARRIER TO KIT CROSS REFERENCE

AXLE MODEL		BASE CARRIER	KIT NUMBER	KIT DESCRIPTION
RT-48-380 RT-52-380 RT-58-380 (cont)	RR-24-380 RR-26-380	3200-M-1833	KIT 1554	Pinion bearing spacer kit
			KIT 2432	Bearing cage shim kit (pre 11-93)
			KIT 2436	Main differential nest with spider 2.35-46 spline
			KIT 2885	Bearing cage shim kit (post 11-93)
			KIT 4443	Bearing kit all except 6.83, 7.17, 7.40 & 7.83 ratios
			KIT 4444	Bearing kit, 6.83, 7.17, 7.40 & 7.83 ratios
			KIT 4445	Bearing update kit - L.H.
			KIT 4446	Bearing update kit - R.H.
RT-70-380	RP-35-380	3200-M-1625	KIT 1554	Pinion bearing spacer kit
			KIT 2422	IAD nest without case, with spider
			KIT 2432	Bearing cage shim kit (pre 11-93)
			KIT 2437	Main differential nest with spider 2.56-50 spline
			KIT 2491	IAD nest without case, without spider
			KIT 2678	Helical gear cover update
			KIT 2885	Bearing cage shim kit (post 11-93)
			KIT 4440	Bearing kit all ratios
			KIT 4445	Bearing update kit - L.H.
			KIT 4446	Bearing update kit - R.H.
			KIT RP35380	Major overhaul kit
			MPS 3355	Helical gear kit
		3200-M-1833	KIT 1554	Pinion bearing spacer kit
			KIT 2422	IAD nest without case, with spider
			KIT 2432	Bearing cage shim kit (pre 11-93)
			KIT 2437	Main differential nest with spider 2.56-50 spline
			KIT 2491	IAD nest without case, without spider
			KIT 2678	Helical gear cover update
			KIT 2885	Bearing cage shim kit (post 11-93)
			KIT 4441	Bearing kit all except 6.83, 7.17, 7.40 & 7.83 ratios
			KIT 4442	Bearing kit, 6.83, 7.17, 7.40 & 7.83 ratios
			KIT 4445	Bearing update kit - L.H.
		KIT 4446	Bearing update kit - R.H.	
		KIT RP35380A	Major overhaul kit	
		MPS 3355	Helical gear kit	
		3200-M-1625	KIT 1554	Pinion bearing spacer kit
			KIT 2432	Bearing cage shim kit (pre 11-93)
			KIT 2437	Main differential nest with spider 2.56-50 spline
			KIT 2885	Bearing cage shim kit (post 11-93)
			KIT 4450	Bearing kit all ratios
			KIT 4445	Bearing update kit - L.H.
			KIT 4446	Bearing update kit - R.H.
KIT RR35380	Major overhaul kit			
3200-M-1833	KIT 1554	Pinion bearing spacer kit		
	KIT 2432	Bearing cage shim kit (pre 11-93)		
	KIT 2437	Main differential nest with spider 2.56-50 spline		
	KIT 2885	Bearing cage shim kit (post 11-93)		
	KIT 4443	Bearing kit all except 6.83, 7.17, 7.40 & 7.83 ratios		
	KIT 4444	Bearing kit, 6.83, 7.17, 7.40 & 7.83 ratios		
	KIT 4445	Bearing update kit - L.H.		
	KIT 4446	Bearing update kit - R.H.		
KIT RR35380A	Major overhaul kit			

SERVICE KITS

A2-3200-A-1899S

ITEM	PART NUMBER	QTY.	DESCRIPTION	REMARKS
1	A2-3200-A-1899	1	Carrier and cap assy.	Malleable with screw-in diff. lock
2	A3261-A-1067	1	Housing - shift cylinder	
3	2230-T-1190	1	Piston	
4	5-X-521	1	O-ring	
5	41-X-1368	1	Caging bolt	
6	2244-Z-1222	1	Push rod	
7	3296-D-1174	1	Fork - shift	
8	2258-N-1262	1	Spring	
9	2206-L-1156	1	Fitting - elbow	

KIT 1536

ITEM	PART NUMBER	QTY.	DESCRIPTION	REMARKS
1	1229-L-2430	2	Snap ring - .088" thick	Output shaft snap ring kit
2	1229-M-2431	2	Snap ring - .091" thick	
3	1229-N-2432	2	Snap ring - .094" thick	
4	1229-P-2434	2	Snap ring - .097" thick	
5	1229-Q-2435	2	Snap ring - .100" thick	
6	1229-R-2436	2	Snap ring - .103" thick	
7	1229-S-2437	2	Snap ring - .106" thick	
8	1229-T-2438	2	Snap ring - .109" thick	
9	1229-U-2439	2	Snap ring - .112" thick	

KIT 1554

ITEM	PART NUMBER	QTY.	DESCRIPTION	REMARKS
1	2203-U-7899	2	Spacer - .326" thick	Pinion bearing spacer kit.
2	2203-V-7900	2	Spacer - .327" thick	
3	2203-W-7901	2	Spacer - .328" thick	
4	2203-X-7902	2	Spacer - .329" thick	
5	2203-Y-7903	2	Spacer - .330" thick	
6	2203-Z-7904	2	Spacer - .331" thick	
7	2203-A-7905	2	Spacer - .332" thick	
8	2203-B-7906	2	Spacer - .338" thick	
9	2203-C-7907	2	Spacer - .345" thick	
10	2203-D-7908	2	Spacer - .352" thick	
11	2203-E-7909	2	Spacer - .359" thick	

KIT 1592

ITEM	PART NUMBER	QTY.	DESCRIPTION	REMARKS
1	2803-Y-2755	4	Shim - .002 inch/.050 mm thick	All
2	2803-Z-2756	2	Shim - .005 inch/.125 mm thick	
3	2803-A-2757	4	Shim - .008 inch/.200 mm thick	
4	2803-B-2758	1	Shim - .020 inch/.500 mm thick	

SERVICE KITS

KIT 1593

ITEM	PART NUMBER	QTY.	DESCRIPTION	REMARKS
1	2803-D-2500	2	Spacer - .250 inch/6.35 mm thick	Pinion bearing spacers
2	2803-E-2501	2	Spacer - .251 inch/6.38 mm thick	
3	2803-F-2502	2	Spacer - .252 inch/6.40 mm thick	
4	2803-N-2510	2	Spacer - .253 inch/6.43 mm thick	
5	2803-G-2503	2	Spacer - .254 inch/6.45 mm thick	
6	2803-H-2504	2	Spacer - .256 inch/6.50 mm thick	
7	2803-J-2506	2	Spacer - .260 inch/6.60 mm thick	
8	2803-K-2507	2	Spacer - .261 inch/6.63 mm thick	
9	2803-L-2508	2	Spacer - .262 inch/6.65 mm thick	
10	2803-M-2509	2	Spacer - .263 inch/6.68 mm thick	

KIT 1594

ITEM	PART NUMBER	QTY.	DESCRIPTION	REMARKS
1	40-X-1182	16	Nut - lock	3200-C-1381, 3200-U-1399, Gear to case bolt kit to be used with gearsets without counter bores in the ring gear bolt hole area only.
2	41-X-1358	16	Capscrew	
3	1229-U-1503	16	Washer	

KIT 2318

ITEM	PART NUMBER	QTY.	DESCRIPTION	REMARKS
1	2233-M-1001	4	Pinion - diff.	Main diff. kit with spider., All
2	2234-C-1069	2	Side gear - diff. (2.36 in.-46 spline)	
3	3278-W-335	1	Spider (differential cross)	
4	1229-L-3002	2	Washer - side gear thrust	
5	1229-K-3001	4	Washer - diff. pinion	

KIT 2341

ITEM	PART NUMBER	QTY.	DESCRIPTION	REMARKS
1	1229-L-3002	2	Washer - side gear thrust	All, Main diff. kit less spider.
2	2234-C-1069	2	Side gear - diff. (2.36 in.-46 spline)	
3	2233-M-1001	4	Pinion - diff.	
4	1229-K-3001	4	Washer - diff. pinion	

SERVICE KITS

KIT 2342

ITEM	PART NUMBER	QTY.	DESCRIPTION	REMARKS
1	1227-N-1340	16	Nut	3200-M-1833, Gear to case bolt kit.
2	1229-U-1555	16	Washer	
3	15-X-1700	16	Bolt	

KIT 2363

ITEM	PART NUMBER	QTY.	DESCRIPTION	REMARKS
1	1227-P-1056	1	Nut - sensor adjusting	3200-C-1381 & 3200-U-1399
2	2257-M-1235	1	Clip - sensor/switch	
3	3107-Z-78	1	Shift collar	
4	3237-W-1167	1	Sensor - switch assembly	
5	3296-N-1184	1	Shift fork	
6	KIT 2282	1	Diff. lock kit	

KIT 2373

ITEM	PART NUMBER	QTY.	DESCRIPTION	REMARKS
1	1229-K-3001	4	Washer - diff. pinion	3200-C-1381, 3200-U-1399, 3200-K-1753, 3200-Q-1791, 3200-J-1804, 3200-A-1899, Main diff. kit with spider
2	1229-L-3002	2	Washer - side gear thrust	
3	2233-M-1001	4	Pinion - diff.	
4	2234-P-1004	2	Side gear - diff. (2.56 in.-50 spline)	
5	3278-W-335	1	Spider (differential cross)	

KIT 2374

ITEM	PART NUMBER	QTY.	DESCRIPTION	REMARKS
1	1229-K-3001	4	Washer - diff. pinion	3200-C-1381, 3200-U-1399, 3200-K-1753, 3200-Q-1791, 3200-J-1804, 3200-A-1899, Main diff. kit less spider
2	1229-L-3002	2	Washer - side gear thrust	
3	2233-M-1001	4	Pinion - diff.	
4	2234-P-1004	2	Side gear - diff. (2.56 in.-50 spline)	

KIT 2421

ITEM	PART NUMBER	QTY.	DESCRIPTION	REMARKS
1	2233-K-245	4	Pinion - diff.	IAD nest with spider, 3200-M-1833, 3200-M-1625
2	2234-F-890	1	Side gear (2.00 in.-39 spline)	
3	3892-W-4963	1	Side gear - helical gear	
4	3278-N-300	1	Spider (differential cross)	
5	1229-L-2742	1	Washer - side gear thrust	
6	1229-Q-2929	4	Washer - pinion thrust	

SERVICE KITS

KIT 2422

ITEM	PART NUMBER	QTY.	DESCRIPTION	REMARKS
1	2233-K-245	4	Pinion - diff.	IAD nest with spider, 3200-M-1625, 3200-M-1833
2	2234-F-890	1	Side gear (2.00 in.-39 spline)	
3	3892-Y-4965	1	Side gear - helical gear	
4	3278-N-300	1	Spider (differential cross)	
5	1229-L-2742	1	Washer - side gear thrust	
6	1229-Q-2929	4	Washer - pinion thrust	

KIT 2432

ITEM	PART NUMBER	QTY.	DESCRIPTION	REMARKS
1	2203-C-6607	1	Shim - .003" thick	3200-M-1625, 3200-M-1833. Pre 11/93. See KIT 2885 for post 11/93.
2	2203-D-6608	1	Shim - .005" thick	
3	2203-E-6609	4	Shim - .010" thick	
4	2203-Z-6604	3	Shim - .003" thick	
5	2203-A-6605	4	Shim - .005" thick	
6	2203-B-6606	1	Shim - .010" thick	

KIT 2436

ITEM	PART NUMBER	QTY.	DESCRIPTION	REMARKS
1	2234-C-1069	2	Side gear - diff. (2.36 in.-46 spline)	3200-M-1625, 3200-M-1833, With diff. spider
2	1229-L-3002	2	Washer - side gear thrust	
3	3278-Q-381	1	Spider - differential	
4	2233-T-1112	4	Pinion - differential	
5	1229-D-992	4	Washer - differential pinion thrust	

KIT 2437

ITEM	PART NUMBER	QTY.	DESCRIPTION	REMARKS
1	2234-G-1229	2	Side gear (2.56 in.-50 spline)	3200-M-1625, 3200-M-1833, With diff. spider
2	1229-L-3002	2	Washer - side gear thrust	
3	3278-Q-381	1	Spider - differential	
4	2233-T-1112	4	Pinion - differential	
5	1229-D-992	4	Washer - differential pinion thrust	

KIT 2484

ITEM	PART NUMBER	QTY.	DESCRIPTION	REMARKS
1	3892-W-4963	1	Side gear - helical gear	3200-M-1625, 3200-M-1833
2	3892-J-4014	1	Helical gear - drive pinion	

SERVICE KITS

KIT 2490

ITEM	PART NUMBER	QTY.	DESCRIPTION	REMARKS
1	2233-K-245	4	Pinion - diff.	IAD nest less spider, 3200-M-1625, 3200-M-1833
2	2234-F-890	1	Side gear (2.00 in.-39 spline)	
3	3892-W-4963	1	Side gear - helical gear	
4	1229-L-2742	1	Washer - side gear thrust	
5	1229-Q-2929	4	Washer - pinion thrust	

KIT 2491

ITEM	PART NUMBER	QTY.	DESCRIPTION	REMARKS
1	2233-K-245	4	Pinion - diff.	3200-M-1625, 3200-M-1833, IAD nest less spider
2	2234-F-890	1	Side gear (2.00 in.-39 spline)	
3	3892-Y-4965	1	Side gear - helical gear	
4	1229-L-2742	1	Washer - side gear thrust	
5	1229-Q-2929	4	Washer - pinion thrust	

KIT 2608

ITEM	PART NUMBER	QTY.	DESCRIPTION	REMARKS
1	40-X-1182	16	Nut - lock	3200-C-1381, 3200-U-1399, 3200-W-1791, 3200-J-1804, Gear to case bolt kit to be used with gearsets with counter bores in the ring gear bolt hole area only.
2	41-X-1334	16	Capscrew	
3	1229-U-1503	16	Washer	

XpresswayPlus.ArvinMeritor.com



XpresswayPlus.ArvinMeritor.com
For all of your parts-ordering needs

Don't forget about using *XpresswayPlus* for:

- Ordering parts online
- Order status
- Price and availability
- Invoice Lookup
- Parts Catalog
- Online e-mail or phone numbers for Customer Service, Information Services, Marketing, Catalog, and eSupport
- Reference Library
- The Company Store
- Literature
- Dealer/Distributor locator

XpresswayPlus is easy to use, can reduce phone calls, and save you valuable time.

SERVICE KITS

KIT 2630

ITEM	PART NUMBER	QTY.	DESCRIPTION	REMARKS
1	3266-F-1020	1	Cover	3200-W-1791, All bolt on style air cylinder cover except 3200-J-1752 & 3200-K-1753.
2	MWA-506	4	Washer	
3	2208-L-1000	1	Gasket	
4	MS-210016-1	1	Capscrew	
5	41-X-1364	4	Capscrew - cylinder cover	
6	2208-H-944	1	Gasket	
7	3196-F-32	1	Tube - air cylinder	
8	5-X-1153	1	O-ring	
9	2230-N-170	1	Piston	
10	42-X-1027	1	Washer	
11	2244-Y-51	1	Shift shaft	
12	2258-L-714	1	Spring	
13	43-X-1007	1	Pin - shift fork	
14	41-X-1333	1	Capscrew	
15	2257-N-40	1	Tie Strap	
16	3296-N-1184	1	Shift fork	
17	3107-L-1104	1	Shift collar	
18	3237-W-1167	1	Sensor - switch assembly	
19	1227-P-1056	1	Nut - sensor adjusting	
20	2257-M-1235	1	Clip - sensor/switch	
21	43-X-1006	1	Pin - shift shaft	

KIT 2638

ITEM	PART NUMBER	QTY.	DESCRIPTION	REMARKS
1	40-X-1233	1	Nut - lock	M45 x 1.5 nut thread.
2	1229-W-4521	1	Washer	

MERITOR.

an *ArvinMeritor* brand

SERVICE KITS

KIT 2678

ITEM	PART NUMBER	QTY.	DESCRIPTION	REMARKS
1	A-3303-P-1030	1	Oil pump assy.	3200-M-1625, 3200-M-1833, Updates to current design pump.
2	1229-E-1669	6	Washer - flat	
3	MS-208045-1	6	Capscrew	
4	2297-Z-5278	1	Adaptor - filter	
5	3280-V-8394	1	Oil filter	
6	3280-Z-8398	1	Filter - shield	
7	A-3297-N-1288	1	Shaft - input assembly	
8	A-3226-H-1126	1	Cage - bearing input	
9	S-2814A-2	6	Capscrew	
10	1229-C-1511	6	Washer - flat	
11	3266-M-1313	1	Cover - helical gear	
12	A-2297-D-5334	1	Screen filter	
13	5-X-1034	1	O-ring	
14	5-X-1343	1	O-ring	
15	2258-Z-1118	1	Spring	
16	2297-U-5273	1	Valve - relief	
17	3296-Q-1187	1	Fork - shift	
18	2244-Y-1221	1	Shaft - shif	
19	A4-3261-Q-1057	1	I.A.D. shift cylinder assy.	
20	2203-K-9241	1	Shim - .003 thick	
21	2203-L-9242	1	Shim - .005 thick	
22	2203-M-9243	4	Shim - .010 thick	
23	HM-813844	1	Cone - bearing	
24	A1-1205-X-2728	1	Oil seal assembly	
25	1227-D-940	1	Nut - input	

If you detect any **errors** in this catalog, please let us know.



We want the information to be as accurate as possible; we appreciate your help in making it so.

Please e-mail any comments/suggestions/corrections to us at: catalogfeedback@arvinmeritor.com

or mail to: ArvinMeritor
attn: Catalog Dept.
7975 Dixie Highway
Florence, KY 41042

SERVICE KITS

KIT 2679

ITEM	PART NUMBER	QTY.	DESCRIPTION	REMARKS
1	A-3303-P-1030	1	Oil pump assy.	3200-M-1625, 3200-M-1833 Updates to current design 380.
2	1229-E-1669	6	Washer - flat	
3	MS-208045-1	6	Capscrew	
4	2297-Z-5278	1	Adaptor - filter	
5	3280-V-8394	1	Oil filter	
6	3280-Z-8398	1	Filter - shield	
7	A-3297-N-1288	1	Shaft - input assembly	
8	A-3226-H-1126	1	Cage - bearing input	
9	S-2814A-2	7	Capscrew	
10	1229-C-1511	7	Washer - flat	
11	3266-Q-1317	1	Helical Gear Cover	
12	A-2297-D-5334	1	Screen filter	
13	5-X-1343	1	O-ring	
14	5-X-1034	1	O-ring	
15	2258-Z-1118	1	Spring	
16	2297-U-5273	1	Valve - relief	
17	3296-Q-1187	1	Fork - shift	
18	2244-Y-1221	1	Shaft - shif	
19	A4-3261-Q-1057	1	I.A.D. shift cylinder assy.	
20	A1-1205-X-2728	1	Seal Assembly	
21	1227-D-940	1	Nut - input	
22	HM-813844	1	Cone – bearing	
23	2203-K-9241	1	Shim - .003 thick	
24	2203-L-9242	1	Shim - .005 thick	
25	2203-M-9243	4	Shim - .010 thick	

KIT 2699

ITEM	PART NUMBER	QTY.	DESCRIPTION	REMARKS
1	2244-Z-1222	1	Push rod	Screw-in style air cylinder cover.
2	2257-M-1235	1	Clip - sensor/switch	
3	2258-N-1262	1	Spring	
4	3107-L-1104	1	Shift collar	
5	3237-W-1167	1	Sensor - switch assembly	
6	A-3261-A-1067	1	Housing – shift cylinder	
7	3296-D-1174	1	Fork – shift	
8	41-X-1368	1	Caging bolt	
9	5-X-521	1	O-ring	

SERVICE KITS

KIT 2731

ITEM	PART NUMBER	QTY.	DESCRIPTION	REMARKS
1	A2-3200-A-1899S	1	Carrier retrofit	With diff. lock (2.93-4.30 ratios), 3200-U-1399, 3200-W-1791
2	A-1-3235-K-2143	1	Differential case assy.	
3	NP-022042	1	Cup - bearing	
4	NP-579116	1	Cone - bearing	
5	JM-822010	1	Cup - bearing	
6	JM-822049	1	Cone - bearing	
7	2214-G-1125	1	Adjusting ring - bearing	
8	2214-S-1137	1	Adjusting ring - bearing	

KIT 2731A

ITEM	PART NUMBER	QTY.	DESCRIPTION	REMARKS
1	A2-3200-A-1899S	1	Carrier retrofit	With diff. lock (4.56-7.83 ratios), 3200-U-1399, 3200-W-1791
2	A-3235-M-2145	1	Differential case assy.	
3	NP-022042	1	Cup - bearing	
4	NP-579116	1	Cone - bearing	
5	JM-822010	1	Cup - bearing	
6	JM-822049	1	Cone - bearing	
7	2214-G-1125	1	Adjusting ring - bearing	
8	2214-S-1137	1	Adjusting ring - bearing	

KIT 2732

ITEM	PART NUMBER	QTY.	DESCRIPTION	REMARKS
1	A2-3200-J-1804	1	Carrier & cap assembly	Less diff.lock (2.93-4.30 ratios), 3200-U-1399, 3200-W-1791
2	A-3235-K-2143	1	Differential case assy.	
3	NP-022042	1	Cup - bearing	
4	NP-579116	1	Cone - bearing	
5	JM-822010	1	Cup - bearing	
6	JM-822049	1	Cone - bearing	
7	2214-G-1125	1	Adjusting ring - bearing	
8	2214-S-1137	1	Adjusting ring - bearing	

KIT 2732A

ITEM	PART NUMBER	QTY.	DESCRIPTION	REMARKS
1	A2-3200-J-1804	1	Carrier & cap assembly	Less diff. lock (4.56-7.83 ratios), 3200-U-1399, 3200-W-1791
2	A-1-3235-M-2145	1	Differential case assy.	
3	NP-022042	1	Cup - bearing	
4	NP-579116	1	Cone - bearing	
5	JM-822010	1	Cup - bearing	
6	JM-822049	1	Cone - bearing	
7	2214-G-1125	1	Adjusting ring - bearing	
8	2214-S-1137	1	Adjusting ring - bearing	

SERVICE KITS

KIT 2744

ITEM	PART NUMBER	QTY.	DESCRIPTION	REMARKS
1	NP-022042	1	Cup - bearing	3200-C-1381, 3200-U-1399, 3200-W-1791, 3200-J-1804, 3200-A-1899, 3200-A-1899, 3200-J-1752, 3200-K-1753
2	NP-579116	1	Cone - bearing	

KIT 2791

ITEM	PART NUMBER	QTY.	DESCRIPTION	REMARKS
1	1229-U-1503	2	Washer	3200-J-1752, 3200-K-1753, Diff. lock retrofit kit with bolt-on style air cyl. cover for 2.35 in.-46 spline collar. (For complete retrofit, must change passenger side axle shaft with an extended splined axle shaft for DCDL. See pages 21-23 for axle shaft listings.)
2	2208-H-944	1	Gasket	
3	2208-L-1000	1	Gasket	
4	2230-N-170	1	Piston	
5	2244-Z-52	1	Shifter shaft	
6	2258-L-714	1	Spring	
7	3107-A-1041	1	Collar	
8	3196-F-32	1	Tube - air cylinder	
9	3237-W-1167	1	Sensor - switch assembly	
10	3266-F-1020	1	Cover	
11	3296-A-1197	1	Shift fork	
12	41-X-1364	4	Capscrew	
13	41-X-1333	1	Capscrew	
14	43-X-1006	1	Pin - shift shaft	
15	5-X-1153	1	O-ring	
16	MS-210016-1	1	Capscrew	
17	MWA-506	4	Washer	

KIT 2791A

ITEM	PART NUMBER	QTY.	DESCRIPTION	REMARKS
1	3266-F-1020	1	Cover	3200-J-1752, 3200-K-1753. Diff. lock retrofit kit with bolt-on style air cyl. cover for 2.56 in.-50 spline collar. (For complete retrofit, must change passenger side axle shaft with an extended splined axle shaft for DCDL. See pages 21-23 for axle shaft listings.)
2	3296-A-1197	1	Shift fork	
3	3107-V-1010	1	Collar	
4	2244-Z-52	1	Shifter shaft	
5	3196-F-32	1	Tube - air cylinder	
6	2230-N-170	1	Piston	
7	43-X-1006	1	Pin - shift shaft	
8	2258-L-714	1	Spring	
9	5-X-1153	1	O-ring	
10	2208-H-944	1	Gasket	
11	MWA-506	4	Washer	
12	41-X-1364	4	Capscrew	
13	2208-L-1000	1	Gasket	
14	MS-210016-1	1	Capscrew	
15	41-X-1333	1	Capscrew	
16	3237-W-1167	1	Sensor - switch assembly	
17	1229-U-1503	2	Washer	

SERVICE KITS

KIT 2792

ITEM	PART NUMBER	QTY.	DESCRIPTION	REMARKS
1	2208-H-944	1	Gasket	3200-J-1752, 3200-K-1753, Major diff. lock repair kit.
2	2208-L-1000	1	Gasket	
3	2230-N-170	1	Piston	
4	2244-Z-52	1	Shifter shaft	
5	2258-L-714	1	Spring	
6	3196-F-32	1	Tube - air cylinder	
7	3266-F-1020	1	Cover	
8	41-X-1094	4	Capscrew	
9	41-X-1333	1	Capscrew	
10	43-X-1006	1	Pin - shift shaft	
11	5-X-1153	1	O-ring	
12	MS-210016-1	1	Capscrew	
13	MWA-506	4	Washer	

KIT 2793

ITEM	PART NUMBER	QTY.	DESCRIPTION	REMARKS
1	2208-H-944	1	Gasket	3200-J-1752, 3200-K-1753, Minor diff. lock repair kit.
2	2208-L-1000	1	Gasket	
3	2230-N-170	1	Piston	
4	2258-L-714	1	Spring	
5	43-X-1006	1	Pin - shift shaft	
6	5-X-1153	1	O-ring	

KIT 2885

ITEM	PART NUMBER	QTY.	DESCRIPTION	REMARKS
1	2203-K-9241	1	Shim - .003" thick	Post 11/93. See KIT 2432 for pre 11/93.
2	2203-L-9242	1	Shim - .005" thick	
3	2203-M-9243	4	Shim - .010" thick	
4	2203-Z-6604	4	Shim - .003" thick	
5	2203-A-6605	4	Shim - .005" thick	
6	2203-B-6606	1	Shim - .010" thick	

KIT 2886

ITEM	PART NUMBER	QTY.	DESCRIPTION	REMARKS
1	2203-K-9241	3	Shim - .003" thick	Post 11/93.
2	2203-L-9242	3	Shim - .005" thick	
3	2203-M-9243	4	Shim - .010" thick	

SERVICE KITS

KIT 4435

ITEM	PART NUMBER	QTY.	DESCRIPTION	REMARKS
1	H-715334	1	Cone - drive pinion outer bearing	3200-C-1381, 3200-U-1399, All ratios except 6.83, 7.17, 7.40 & 7.83
2	H-715311	1	Cup - drive pinion outer bearing	
3	1228-V-594	1	Cone - drive pinion inner bearing	
4	9220	1	Cup - drive pinion inner bearing	
5	JHM-720210	1	Cup - diff. bearing L.H.	
6	JHM-720249	1	Cone - diff. bearing L.H.	
7	1228-S-1267	1	Spigot bearing	
8	A1-1205-A-2731	1	Oil seal assembly	
9	64700	1	Cup - diff. bearing R.H.	
10	64450	1	Cone - diff. bearing R.H.	

KIT 4436

ITEM	PART NUMBER	QTY.	DESCRIPTION	REMARKS
1	H-715334	1	Cone - drive pinion outer bearing	6.83, 7.17, 7.40 & 7.83 ratios only, 3200-C-1381, 3200-U-1399
2	H-715311	1	Cup - drive pinion outer bearing	
3	1228-V-594	1	Cone - drive pinion inner bearing	
4	9220	1	Cup - drive pinion inner bearing	
5	JHM-720210	1	Cup - diff. bearing L.H.	
6	JHM-720249	1	Cone - diff. bearing L.H.	
7	1228-A-261	1	Spigot bearing	
8	A1-1205-A-2731	1	Oil seal assembly	
9	64700	1	Cup - diff. bearing R.H.	
10	64450	1	Cone - diff. bearing R.H.	

KIT 4437

ITEM	PART NUMBER	QTY.	DESCRIPTION	REMARKS
1	H-715334	1	Cone - drive pinion outer bearing	All ratios except 6.83, 7.17, 7.40 & 7.83, 3200-W-1791, 3200-A-1899, 3200-J-1804, 3200-S-1839
2	H-715311	1	Cup - drive pinion outer bearing	
3	1228-V-594	1	Cone - drive pinion inner bearing	
4	9220	1	Cup - drive pinion inner bearing	
5	NP-022042	1	Cup - bearing	
6	NP-579116	1	Cone - bearing	
7	1228-S-1267	1	Spigot bearing	
8	A1-1205-A-2731	1	Oil seal assembly	
9	JM-822010	1	Cup - bearing	
10	JM-822049	1	Cone - bearing	

SERVICE KITS

KIT 4438

ITEM	PART NUMBER	QTY.	DESCRIPTION	REMARKS
1	H-715334	1	Cone - drive pinion outer bearing	6.83, 7.17, 7.40 & 7.83 ratios only, 3200-W-1791, 3200-A-1899, 3200-J-1804, 3200-S-1839
2	H-715311	1	Cup - drive pinion outer bearing	
3	1228-V-594	1	Cone - drive pinion inner bearing	
4	9220	1	Cup - drive pinion inner bearing	
5	NP-022042	1	Cup - bearing	
6	NP-579116	1	Cone - bearing	
7	1228-A-261	1	Spigot bearing	
8	A1-1205-A-2731	1	Oil seal assembly	
9	JM-822010	1	Cup - bearing	
10	JM-822049	1	Cone - bearing	

KIT 4440

ITEM	PART NUMBER	QTY.	DESCRIPTION	REMARKS
1	A-1228-R-1266	1	Race - pinion bearing outer (spigot)	3200-M-1625
2	78551	2	Cup - pinion bearing inner and outer	
3	78250AC	2	Cone - pinion bearing inner and outer	
4	52387P	1	Cone - diff. bearing L.H.	
5	52618P	1	Cup - diff bearing L.H.	
6	NP-928171	1	Cone - diff. bearing R.H.	
7	NP-718759	1	Cup - diff. bearing R.H.	
8	A-1228-Z-572	1	Bearing - pump idler gear	
9	382AK	2	Cup - bearing	
10	385AK	2	Cone - bearing	
11	A-1205-C-1927	1	Oil seal assembly	
12	1229-T-4076	1	Snap ring	
13	A1-1205-X-2728	1	Oil seal assembly	
14	JM-515610	1	Cup - rear side gear bearing	
15	JM-515649	1	Cone - rear side gear bearing	
16	HM-813810	1	Cup - bearing	
17	HM-813844	1	Cone - bearing	
18	1221-R-1006	1	Cup - bearing	
19	1221-S-1007	1	Cone - bearing	

SERVICE KITS

KIT 4441

ITEM	PART NUMBER	QTY.	DESCRIPTION	REMARKS
1	1229-L-1624	1	Snap ring	3200-M-1833 All ratios except 6.83, 7.17, 7.40 & 7.83 For rear-rear 380s (which are less IAD) use KIT 4443.
2	78551	2	Cup - pinion bearing inner and outer	
3	78250AC	2	Cone - pinion bearing inner and outer	
4	52387P	1	Cone - diff. bearing L.H.	
5	52618P	1	Cup - diff bearing L.H.	
6	NP-718759	1	Cup - diff. bearing R.H.	
7	NP-928171	1	Cone - diff. bearing R.H.	
8	A-1228-Z-572	1	Bearing - pump idler gear	
9	382A	2	Cup - bearing	
10	385A	2	Cone - bearing	
11	A-1205-C-1927	1	Oil seal assembly	
12	1228-S-1267	1	Spigot bearing	
13	A1-1205-X-2728	1	Oil seal assembly	
14	JM-515610	1	Cup - rear side gear bearing	
15	JM-515649	1	Cone - rear side gear bearing	
16	HM-813810	1	Cup - bearing	
17	HM-813844	1	Cone - bearing	

KIT 4442

ITEM	PART NUMBER	QTY.	DESCRIPTION	REMARKS
1	1228-A-261	1	Spigot bearing	3200-M-1833 6.83, 7.17, 7.40 & 7.83 ratios only. For rear-rear 380s (which are less IAD) use KIT 4444.
2	1229-K-1623	1	Snap ring	
3	78551	2	Cup - pinion bearing inner and outer	
4	78250AC	2	Cone - pinion bearing inner and outer	
5	52387P	1	Cone - diff. bearing L.H.	
6	52618P	1	Cup - diff bearing L.H.	
7	NP-718759	1	Cup - diff. bearing R.H.	
8	NP-928171	1	Cone - diff. bearing R.H.	
9	A-1228-Z-572	1	Bearing - pump idler gear	
10	382A	2	Cup - bearing	
11	385A	2	Cone - bearing	
12	A-1205-C-1927	1	Oil seal assembly	
13	A1-1205-X-2728	1	Oil seal assembly	
14	JM-515610	1	Cup - rear side gear bearing	
15	JM-515649	1	Cone - rear side gear bearing	
16	HM-813810	1	Cup - bearing	
17	HM-813844	1	Cone - bearing	

SERVICE KITS

KIT 4443

ITEM	PART NUMBER	QTY.	DESCRIPTION	REMARKS
1	1228-S-1267	1	Spigot bearing	3200-M-1833
2	78551	2	Cup - pinion bearing inner and outer	All less Inter-axle and less pump except ratios 6.83, 7.17, 7.40 & 7.83
3	78250AC	2	Cone - pinion bearing inner and outer	
4	52387P	1	Cone - diff. bearing L.H.	
5	52618P	1	Cup - diff bearing L.H.	
6	NP-718759	1	Cup - diff. bearing R.H.	
7	NP-928171	1	Cone - diff. bearing R.H.	
8	R945008	1	Oil seal assembly	
9	29620	1	Cup - input shaft inner bearing	
10	29685	1	Cone - input shaft inner bearing	
11	493	1	Cup - input shaft outer bearing	
12	496	1	Cone - input shaft outer bearing	
13	1229-L-1624	1	Snap ring	

KIT 4444

ITEM	PART NUMBER	QTY.	DESCRIPTION	REMARKS
1	1228-A-261	1	Spigot bearing	3200-M-1833
2	78551	2	Cup - pinion bearing inner and outer	All less Inter-axle and less pump for 6.83, 7.17, 7.40 & 7.83 ratios only
3	78250AC	2	Cone - pinion bearing inner and outer	
4	52387P	1	Cone - diff. bearing L.H.	
5	52618P	1	Cup - diff bearing L.H.	
6	NP-718759	1	Cup - diff. bearing R.H.	
7	NP-928171	1	Cone - diff. bearing R.H.	
8	R945008	1	Oil seal assembly	
9	29620	1	Cup - input shaft inner bearing	
10	29685	1	Cone - input shaft inner bearing	
11	493	1	Cup - input shaft outer bearing	
12	496	1	Cone - input shaft outer bearing	
13	1229-K-1623	1	Snap ring	

KIT 4445

ITEM	PART NUMBER	QTY.	DESCRIPTION	REMARKS
1	NP-718759	1	Cup - diff. bearing L.H.	3200-M-1625, 3200-M-1833,
2	NP-928171	1	Cone - diff. bearing L.H.	Diff. bearing upgrade L.H.

KIT 4446

ITEM	PART NUMBER	QTY.	DESCRIPTION	REMARKS
1	52387P	1	Cone - diff. bearing R.H.	3200-M-1625, 3200-M-1833,
2	52618P	1	Cup - diff bearing R.H.	Diff. bearing upgrade R.H.

SERVICE KITS

KIT 4450

ITEM	PART NUMBER	QTY.	DESCRIPTION	REMARKS
1	78551	2	Cup - pinion bearing inner and outer	3200-M-1625, All less I.A.D. and less pump.
2	78250AC	2	Cone - pinion bearing inner and outer	
3	52387P	1	Cone - diff. bearing L.H.	
4	52618P	1	Cup - diff bearing L.H.	
5	NP-928171	1	Cone - diff. bearing R.H.	
6	NP-718759	1	Cup - diff. bearing R.H.	
7	29620	1	Cup - input shaft inner bearing	
8	493	1	Cup - input shaft outer bearing	
9	29685	1	Cone - input shaft inner bearing	
10	496	1	Cone - input shaft outer bearing	
11	1221-R-1006	1	Cup - bearing	
12	R945008	1	Oil seal assembly	
13	A5-1228-R-1266	1	Roller bearing assembly	

KIT 4459

ITEM	PART NUMBER	QTY.	DESCRIPTION	REMARKS
1	A1-1205-A-2731	1	Oil seal assembly	3200-J-1752, 3200-K-1753, All ratios except 6.83, 7.17, 7.40 and 7.83
2	H-715334	1	Cone - drive pinion outer bearing	
3	H-715311	1	Cup - drive pinion outer bearing	
4	1228-V-594	1	Cone - drive pinion inner bearing	
5	9220	1	Cup - drive pinion inner bearing	
6	64700	1	Cup - diff. bearing R.H.	
7	64450	1	Cone - diff. bearing R.H.	
8	1228-S-1267	1	Spigot bearing	
9	JHM-720249	1	Cone - diff. bearing L.H.	
10	JHM-720210	1	Cup - diff. bearing L.H.	

KIT 4460

ITEM	PART NUMBER	QTY.	DESCRIPTION	REMARKS
1	A1-1205-A-2731	1	Oil seal assembly	3200-J-1752, 3200-K-1753, 6.83, 7.17, 7.40 and 7.83 ratios only.
2	H-715334	1	Cone - drive pinion outer bearing	
3	H-715311	1	Cup - drive pinion outer bearing	
4	1228-V-594	1	Cone - drive pinion inner bearing	
5	9220	1	Cup - drive pinion inner bearing	
6	64700	1	Cup - diff. bearing R.H.	
7	64450	1	Cone - diff. bearing R.H.	
8	1228-A-261	1	Spigot bearing	
9	JHM-720249	1	Cone - diff. bearing L.H.	
10	JHM-720210	1	Cup - diff. bearing L.H.	

SERVICE KITS

KIT 4744

ITEM	PART NUMBER	QTY.	DESCRIPTION	REMARKS
1	10-X-1595	4	Bolt	3200-K-1753, 3200-J-1752, Carrier to axle housing bolt kit
2	10-X-1597	2	Blot	
3	10-X-1599	4	Bolt	
4	1229-W-1557	14	Washer	
5	4-X-1445	4	Stud	
6	N-110-1	4	Nut	

KIT RP180 1625

ITEM	PART NUMBER	QTY.	DESCRIPTION	REMARKS
1	KIT 2436	1	Main differential kit	3200-M-1625, Forward carrier with I.A.D. and main differential.
2	KIT 1554	1	Spacer kit	
3	KIT 2432	1	Shim kit	
4	KIT 2421	1	I.A.D. kit	
5	KIT 1536	1	Shim kit	
6	KIT 4440	1	Bearing and seal kit	
7	1227-D-940	1	Nut - input	
8	1227-J-946	1	Nut - output shaft	
9	1227-P-900	1	Nut - pinion	

KIT RP180 1833

ITEM	PART NUMBER	QTY.	DESCRIPTION	REMARKS
1	1227-P-900	1	Nut - pinion	3200-M-1833, Forward carrier with I.A.D. and main differential.
2	1228-A-261	1	Spigot bearing	
3	1229-K-1623	1	Snap ring	
4	1227-D-940	1	Nut - input	
5	1227-J-946	1	Nut - output shaft	
6	KIT 2432	1	Shim kit	
7	KIT 2421	1	I.A.D. kit	
8	KIT 1536	1	Shim kit	
9	KIT 1554	1	Spacer kit	
10	KIT 2436	1	Main differential kit	
11	KIT 2886	1	Shim kit	
12	KIT 4441	1	Bearing and seal kit	

KIT RP35380

ITEM	PART NUMBER	QTY.	DESCRIPTION	REMARKS
1	KIT 1554	1	Spacer kit	3200-M-1625, Forward carrier with I.A.D. and main differential.
2	KIT 2432	1	Shim kit	
3	KIT 1536	1	Shim kit	
4	1227-P-900	1	Nut - pinion	
5	1227-D-940	1	Nut - input	
6	1227-J-946	1	Nut - output shaft	

SERVICE KITS

KIT RP35380A

ITEM	PART NUMBER	QTY.	DESCRIPTION	REMARKS
1	KIT 2437	1	Main differential kit	3200-M-1833, Forward carrier with I.A.D. and main differential.
2	KIT 1554	1	Spacer kit	
3	KIT 2432	1	Shim kit	
4	KIT 2422	1	I.A.D. kit	
5	KIT 1536	1	Shim kit	
6	1227-P-900	1	Nut - pinion	
7	1227-D-940	1	Nut - input	
8	1227-J-946	1	Nut - output shaft	
9	KIT 4441	1	Bearing and seal kit	
10	1228-A-261	1	Spigot bearing	
11	1229-K-1623	1	Snap ring	
12	KIT 2886	1	Shim kit	

KIT RP380

ITEM	PART NUMBER	QTY.	DESCRIPTION	REMARKS
1	KIT 2436	1	Main differential kit	3200-M-1625, For all double reduction front units with pump and I.A.D. except 70,000 lb. capacity tandems.
2	KIT 1554	1	Spacer kit	
3	KIT 2432	1	Shim kit	
4	KIT 2422	1	I.A.D. kit	
5	KIT 1536	1	Shim kit	
6	1227-P-900	1	Nut - pinion	
7	1227-D-940	1	Nut - input	
8	1227-J-946	1	Nut - output shaft	
9	KIT 4440	1	Bearing and seal kit	

KIT RP380A

ITEM	PART NUMBER	QTY.	DESCRIPTION	REMARKS
1	KIT 2436	1	Main differential kit	3200-M-1833, For all double reduction front units with pump and I.A.D. except 70,000 lb. capacity tandems.
2	KIT 1554	1	Spacer kit	
3	KIT 2432	1	Shim kit	
4	KIT 2422	1	I.A.D. kit	
5	KIT 1536	1	Shim kit	
6	KIT 2886	1	Shim kit	
7	1227-P-900	1	Nut - pinion	
8	1227-D-940	1	Nut - input	
9	1227-J-946	1	Nut - output shaft	
10	KIT 4441	1	Bearing and seal kit	
11	1228-A-261	1	Spigot bearing	
12	1229-K-1623	1	Snap ring	

SERVICE KITS

KIT RR26185-1752

ITEM	PART NUMBER	QTY.	DESCRIPTION	REMARKS
1	KIT 1592	1	Shim kit	2.35-46 spline. 3200-J-1752, 3200-K-1753. Ratios 2.93-6.43
2	KIT 1593	1	Spacer kit	
3	KIT 2318	1	Main diff. kit with spider	
4	KIT 4459	1	Bearing and seal kit	

KIT RR26185A-1752

ITEM	PART NUMBER	QTY.	DESCRIPTION	REMARKS
1	KIT 1592	1	Shim kit	2.35-46 spline. 3200-J-1752, 3200-K-1753. Ratios 6.83-7.83
2	KIT 1593	1	Spacer kit	
3	KIT 2318	1	Main diff. kit with spider	
4	KIT 4460	1	Bearing and seal kit	

KIT RR35380

ITEM	PART NUMBER	QTY.	DESCRIPTION	REMARKS
1	KIT 2437	1	Main differential kit	3200-M-1625
2	KIT 1554	1	Spacer kit	
3	KIT 2432	1	Shim kit	
4	1227-P-900	1	Nut - pinion	
5	1227-J-946	1	Nut - output shaft	
6	KIT 4450	1	Bearing and seal kit	

KIT RR35380A

ITEM	PART NUMBER	QTY.	DESCRIPTION	REMARKS
1	KIT 2437	1	Main differential kit	3200-M-1833
2	KIT 1554	1	Spacer kit	
3	KIT 2432	1	Shim kit	
4	1227-P-900	1	Nut - pinion	
5	1227-J-946	1	Nut - output shaft	
6	KIT 4443	1	Bearing and seal kit	
7	1228-A-261	1	Spigot bearing	
8	1229-K-1623	1	Snap ring	
9	KIT 2886	1	Shim kit	

KIT RR380

ITEM	PART NUMBER	QTY.	DESCRIPTION	REMARKS
1	KIT 2436	1	Main differential kit	3200-M-1625
2	KIT 1554	1	Spacer kit	
3	KIT 2432	1	Shim kit	
4	1227-P-900	1	Nut - pinion	
5	1227-J-946	1	Nut - output shaft	
6	KIT 4450	1	Bearing and seal kit	

KIT RR380A

ITEM	PART NUMBER	QTY.	DESCRIPTION	REMARKS
1	KIT 1554	1	Spacer kit	3200-M-1833
2	KIT 2432	1	Shim kit	
3	KIT 2886	1	Shim kit	
4	1227-J-946	1	Nut - output shaft	
5	1227-P-900	1	Nut - pinion	
6	1228-A-261	1	Spigot bearing	
7	KIT 2436	1	Main differential kit	
8	KIT 4443	1	Bearing and seal kit	

KIT RS23180

ITEM	PART NUMBER	QTY.	DESCRIPTION	REMARKS
1	KIT 2318	1	Main diff. kit with spider	3200-C-1381, 3200-U-1399
2	KIT 1592	1	Shim kit	
3	KIT 1593	1	Spacer kit	
4	KIT 4435	1	Bearing and seal kit	

KIT RS23180A

ITEM	PART NUMBER	QTY.	DESCRIPTION	REMARKS
1	KIT 1592	1	Shim kit	3200-W-1791, 3200-A-1899, 3200-J-1804
2	KIT 1593	1	Spacer kit	
3	KIT 2318	1	Main diff. kit with spider	
4	KIT 4437	1	Bearing and seal kit	

MPS 3355

ITEM	PART NUMBER	QTY.	DESCRIPTION	REMARKS
1	3892-Y-4965	1	Side gear - helical gear	3200-M-1625, 3200-M-1833
2	3892-B-4708	1	Helical gear - drive pinion	

MERITOR

an *ArvinMeritor* brand

XpresswayPlus.ArvinMeritor.com



XpresswayPlus.ArvinMeritor.com
For all of your parts-ordering needs

Don't forget about using *XpresswayPlus* for:

- Ordering parts online
- Order status
- Price and availability
- Invoice Lookup
- Parts Catalog
- Online e-mail or phone numbers for Customer Service, Information Services, Marketing, Catalog, and eSupport
- Reference Library
- The Company Store
- Literature
- Dealer/Distributor locator

XpresswayPlus is easy to use, can reduce phone calls, and save you valuable time.

WHAT YOU NEED:	WHERE TO LOOK:
ACCOUNT CHANGE	CUSTOMER SERVICE
AFTERMARKET & PRODUCTION ASSEMBLIES	CATALOG
APPLICATION INFORMATION	CATALOG
BILL-OF-LADING NUMBER	ORDER STATUS
BILL-OF-MATERIAL	CATALOG
BULLETINS	REFERENCE LIBRARY
CONTACT NAMES & NUMBERS	CUSTOMER SERVICE
FIELD SUPPORT REPRESENTATIVES	CUSTOMER SERVICE
INVOICE (VIEW & PRINT)	ORDER STATUS
NEWSLETTER	REFERENCE LIBRARY
ORDER DETAILS	ORDER STATUS
ORDER HISTORY FILE	ORDER STATUS
ORDER MERCHANDISE	COMPANY STORE
ORDER SUBMIT	CREATE NEW ORDER
ORDER SUBMIT - STOCK UPLOAD (MULTIPLE LINES)	CREATE NEW ORDER
PART DETAILS	CATALOG
PART IMAGES	CATALOG
PART NUMBER COMPARISON	CATALOG
PARTS BOOKS	REFERENCE LIBRARY
PASSWORD CHANGE	CUSTOMER SERVICE
PRICE (LIST)	CATALOG
PRICE (NET) & AVAILABILITY	PRICE & AVAILABILITY
PRODUCT BROCHURES	REFERENCE LIBRARY
PRODUCT UPDATES	REFERENCE LIBRARY
PROOF-OF-DELIVERY	ORDER STATUS
REQUEST-FOR-QUOTATION (FOR MERITOR BRAND)	PRICE REQUEST
SALES LITERATURE	REFERENCE LIBRARY
SEND QUESTIONS, COMMENTS, ISSUES	CONTACT US
SHIPPER NUMBER	ORDER STATUS
TECH TIPS	REFERENCE LIBRARY
TRACKING NUMBER	ORDER STATUS
WARRANTY INFORMATION	REFERENCE LIBRARY
WHERE-USED INFORMATION	CATALOG

NUMERICAL PARTS LISTING

PART NUMBER	PAGE	PART NUMBER	PAGE	PART NUMBER	PAGE
4-X-1051	17	A-1205-S-1657	18	1229-R-2436	16
4-X-1929	17	A-1205-Z-1820	18	1229-S-2437	16
5-X-521	14	A-1205-C-1927	16	1229-T-2438	16
5-X-1034	5	A-1205-R-2410	18	1229-U-2439	16
5-X-1153	14	A-1205-Q-2591	9	1229-L-2742	4
5-X-1198	14	A1-1205-X-2728	5, 7	1229-Q-2929	4
10-X-1334	5	1220-K-89	11	1229-K-3001	13
10-X-1595	17	1220-S-1085	1	1229-L-3002	2, 13
10-X-1596	17	1227-R-330	18	1229-T-3062	16
10-X-1597	17	1227-F-448	18	1229-F-4062	4
10-X-1599	17	1227-D-472	2, 10	1229-T-4076	2
10-X-1601	17	1227-W-517	18	1229-D-4632	9
10-X-1669	3, 5	1227-A-547	18	1229-F-4634S	18
15-X-1167	2, 10	1227-P-900	3	1244-U-879	18
15-X-1698	2	1227-D-940	5, 7	1246-M-455	2
15-X-1699	2	1227-J-946	7, 16	1246-Q-615	6
15-X-1700	1	1227-P-1056	15	1246-P-1134	11
40-X-1015	10	1227-M-1339	1	1250-E-473	17
40-X-1182	12, 14	1227-N-1340	1	1250-N-1080	4
40-X-1233	9	1228-A-261	3, 10	1250-U-1217	11
41-X-1018	11	A-1228-Z-572	6	1829-J-738	6
41-X-1020	10	1228-V-594	9	2203-Z-6604	3
41-X-1022	11	A4-1228-R-1266	3	2203-A-6605	3
41-X-1037	11	A5-1228-R-1266	3	2203-B-6606	3
41-X-1043	9	1228-S-1267	3, 10	2203-C-6607	4
41-X-1080	11, 15	1229-V-48	18	2203-D-6608	4
41-X-1109	14	1229-D-992	2	2203-E-6609	4
41-X-1275	14	1229-U-1503	2, 11, 12, 14, 15	2203-U-7899	3, 7
41-X-1333	14	1229-C-1511	3, 4, 6	2203-V-7900	3, 7
41-X-1334	12	1229-E-1513	16	2203-W-7901	3, 7
41-X-1358	12	1229-U-1555	1	2203-X-7902	3, 7
41-X-1364	15	1229-W-1557	1, 12, 14, 17	2203-Y-7903	3, 7
41-X-1368	14	1229-K-1597	4, 5, 7	2203-Z-7904	3, 7
42-X-1024	10	1229-K-1623	2, 10	2203-A-7905	3, 7
42-X-1027	14	1229-L-1624	2, 10	2203-B-7906	3, 7
43-X-1006	14	1229-M-1625	2	2203-C-7907	3, 7
43-X-1007	14	1229-B-1666	7	2203-D-7908	3, 7
43-X-1015	11	1229-E-1669	1, 5, 6, 7	2203-E-7909	3, 7
45-X-1003	11	1229-N-1730	5, 7, 9	2203-K-9241	4
45-X-1008	11	1229-T-1736	7, 16	2203-L-9242	4
A2-3260-N-1262	25	1229-K-2429	3	2203-M-9243	4
1199-B-1666	18	1229-L-2430	16	2208-H-944	14
1199-R-2176	11	1229-M-2431	16	2208-L-1000	15
A-1199-Z-3328	2	1229-N-2432	16	2214-K-89	1
A-1199-R-1048	17	1229-P-2434	16	2214-M-91	1
A-1199-W-4053	16	1229-Q-2435	16	2214-Q-277	11

NUMERICAL PARTS LISTING

PART NUMBER	PAGE	PART NUMBER	PAGE	PART NUMBER	PAGE
2214-S-279	11	2803-P-2512	9	3202-G-9159	21
2214-W-1011	11	2803-Y-2755	9	3202-P-9246	23
2214-X-1012	11	2803-Z-2756	9	3202-Q-9247	23
2214-G-1125	11	2803-A-2757	9	3202-R-9248	22
2214-S-1137	11	2803-B-2758	9	3202-S-9249	22
2230-N-170	14	3107-P-16	4	3202-K-9267	21
2230-T-1190	14	3107-Z-78	14	3202-M-9269	22
2233-K-245	4	3107-V-1010	14	3202-J-9344	21
2233-M-1001	13	3107-A-1041	14	3202-L-9346	22
2233-T-1112	2	3107-L-1104	14	3202-J-9370	21
2234-F-890	3	3107-N-1106	14	3202-L-9372	22
2234-P-1004	13	3196-T-20	7	3202-N-9374	22
2234-C-1069	2, 13	3196-U-21	7	3202-E-9391	21
2234-G-1229	2	3196-B-28	6	3202-F-9392	21
2244-Y-51	14	3196-F-32	14	3202-G-9393	21
2244-Z-52	14	A2-3200-C-1381	10	3202-J-9396	22
2244-K-1025	5	A2-3200-M-1625	2	3202-N-9400	22
2244-V-1114	14	A2-3200-J-1752	10	3202-Q-9403	22
2245-E-31	18	A2-3200-K-1753	10	3202-W-9409	22
2257-S-1033	7	A2-3200-J-1804	10	3202-Y-9411	23
2258-U-411	5	A2-3200-M-1833	2	3202-R-9456	22
2258-L-714	14	A2-3200-A-1899S	10, 32	3202-T-9458	22
2258-Z-1118	4	3202-H-6768	21	3202-E-9495	21
2258-N-1262	14	3202-R-6778	21	3202-F-9496	21
2296-A-105	7	3202-S-6779	21	3202-G-9497	22
2296-B-106	7	3202-L-7734	22	3202-K-9501	21
2296-F-1098	7	3202-M-7735	21	3202-L-9502	22
2296-G-1099	7	3202-W-7745	21	3202-J-9552	22
2297-E-2293	6	3202-M-7787	23	3202-L-9554	22
2297-X-2494	5	3202-N-7788	23	3202-K-9579	21
2297-C-3799	7	3202-C-7803	22	3202-L-9580	21
2297-T-4180	12	3202-D-7804	22	3202-M-9581	22
2297-U-5273	4	3202-X-8110	22	3202-W-9643	21
2297-Z-5278	6	3202-Y-8111	21	3202-Y-9645	21
A-2297-D-5334	6	3202-Z-8112	21	3202-C-9805	23
2297-L-5420	6	3202-H-8666	22	3202-D-9806	23
2297-A-7021	16, 17	3202-B-8816	22	3206-T-1476	22
2297-C-7049	14	3202-G-9003	22	3206-U-1477	21
2803-D-2500	9	3202-H-9004	21	3221-H-8	6
2803-E-2501	9	3202-W-9097	22	A-3226-Z-598	3
2803-F-2502	9	3202-X-9098	21	A-3226-J-790	4
2803-H-2504	9	3202-Y-9125	21	A-3226-B-860	9
2803-J-2506	9	3202-C-9129	22	A-3226-Q-901	16
2803-K-2507	9	3202-P-9142	22	A1-3226-Q-901	16
2803-L-2508	9	3202-Q-9143	21	A-3226-V-1010	9
2803-M-2509	9	3202-V-9148	21	A-3226-H-1126	4
2803-N-2510	9	3202-W-9149	21	A-3230-N-1028	2

NUMERICAL PARTS LISTING

PART NUMBER	PAGE	PART NUMBER	PAGE	PART NUMBER	PAGE
A-3230-A-1041	14	A-3260-U-73	24	3278-W-335	13
A-3230-C-1043	14	A2-3260-U-73	24	3278-Q-381	2
A-3230-E-1045	2	A2-3260-W-75	24	3280-V-5040	5
A-3235-X-1532	3	A-3260-Q-95	26	3280-V-8394	5
A1-3235-X-1532	3	A2-3260-Q-95	26	3280-Z-8398	5
A-3235-F-1618	13	3260-G-111	24	A-3280-F-8430	5
A5-3235-F-1618	12	3260-L-116	24	3296-L-90	4
A6-3235-F-1618	13	A2-3260-L-116	24	3296-D-1174	14
A-3235-H-1620	13	3260-M-117	26	3296-N-1184	14
A3-3235-H-1620	13	A2-3260-M-117	26	3296-Q-1187	4
A5-3235-H-1620	13	A2-3260-U-151	27	3296-A-1197	14
A-3235-T-1944	1	A-3260-R-356	24	3297-W-75	16
A3-3235-T-1944	1	A1-3260-R-356	24	A-3297-S-97	6
A5-3235-T-1944	1	A-3260-S-357	24	A1-3297-K-115	4
A6-3235-T-1944	1	A1-3260-S-357	24	A-3297-M-117	6
A7-3235-T-1944	1	A-3260-Y-1143	24	A1-3297-N-1288	4
A-3235-U-1945	1	A-3260-D-1148	26	A1-3303-L-12	5
A3-3235-U-1945	2	A-3260-M-1235	25	A-3303-M-13	7
A5-3235-U-1945	2	A-3260-D-1252	27	A-3303-P-1030	5
A6-3235-U-1945	1	A-3260-K-1259	25	3780-R-382	6
A7-3235-U-1945	1	A1-3260-K-1259	25	3892-J-4014	3
A-3235-K-2143	13	A-3260-N-1262	25	3892-S-4023	3
A1-3235-K-2143	13	A-3260-Q-1265	25	3892-B-4708	3
A2-3235-K-2143	12	A1-3260-Q-1265	25	3892-D-4710	3
A3-3235-K-2143	12	A2-3260-S-1267	25	3892-F-4712	7
A4-3235-K-2143	13	3260-F-1280	25	3892-V-4936	5
A5-3235-K-2143	12	3260-R-1292	25	3892-W-4937	6
A7-3235-K-2143	12	A2-3260-R-1292	25	3892-W-4963	4
A-3235-M-2145	13	A-3260-B-1302	25	3892-Y-4965	4
A1-3235-M-2145	13	A1-3260-B-1302	25	3892-M-5213	4
A2-3235-M-2145	13	A-3260-N-1314	24	382A	16
A3-3235-M-2145	13	A-3260-G-1645	24	385A	16
A4-3235-M-2145	13	A2-3260-G-1645	24	493	6
A5-3235-M-2145	13	A-3260-R-1682	25	496	6
A6-3235-M-2145	13	A2-3261-Q-1057	5	572	18
A7-3235-M-2145	13	3261-A-1067	14	580	18
A-3235-U-2335	13	3264-P-172	9	592A	18
A1-3235-U-2335	12	A-3266-L-792	6	598A	18
A2-3235-U-2335	12	A-3266-Y-831	7	742	18
A-3235-W-2337	13	A1-3266-B-834	6	749	18
A1-3235-W-2337	13	3266-M-897	11, 15	772	18
A2-3235-W-2337	13	3266-F-1020	14	782	18
A-3235-Y-2339	13	3266-M-1313	5	6535	18
A1-3235-Y-2339	12	3266-Q-1317	5	6580	18
A2-3235-Y-2339	12	A-3266-P-1446	7	9220	9
3237-W-1167	15	3278-N-300	4	29620	6

NUMERICAL PARTS LISTING

PART NUMBER	PAGE	PART NUMBER	PAGE	PART NUMBER	PAGE
29685	6	A-40632-1	10	KIT 1554	32
52387P	1	A-40634-1	10	KIT 1592	32
52618P	1	A-40636-1	10	KIT 1593	33
64450	12	A-40638-1	10	KIT 1594	33
64700	11	B-40312-4	2	KIT 2266	5
78250AC	3	B-40352-4	2	KIT 2268	4
78551	3	B-40354-4	2	KIT 2318	33
9680368	7	B-40356-4	2	KIT 2341	33
16N-4-6271	24	B-40358-4	2	KIT 2342	34
16N-4-6271-1	25	B-40360-4	2	KIT 2363	34
16NYS38-11A	24	B-40362-4	2	KIT 2373	34
16TYS38-11A	25	B-40364-4	2	KIT 2374	34
176N-4-861-1X	25	B-40366-4	2	KIT 2421	34
176N-4-861X	24	B-40368-4	2	KIT 2422	35
176NYS38-13A1	24	B-41002-1	10	KIT 2432	35
176TYS32-3A2	25	B-41004-3	9	KIT 2436	35
176TYS38-13A1	25	B-41006-3	9	KIT 2437	35
17N-4-5961X	24	B-41008-3	10	KIT 2484	35
17N-4-6961-1X	25	B-41010-3	10	KIT 2490	36
17N-4-6961X	24	B-41012-3	10	KIT 2491	36
17N-4-7621-1	25	B-41014-3	9	KIT 2608	36
17N-4-7851X	24	B-41016-3	9	KIT 2630	37
17NYS32-99	24	B-41018-3	9	KIT 2638	9, 37
17NYS32-99A3	24	B-41020-1	10	KIT 2678	5, 38
17NYS32-100A	24	B-41022-1	10	KIT 2679	5, 39
17NYS32-100A2	24	B-41024-4	10	KIT 2699	39
17NYS38-17A2	24	B-41026-3	9	KIT 2731	10, 40
17TYS32-68A2	25	B-41028-3	10	KIT 2731A	10, 40
17TYS32-99	25	B-41030-3	9	KIT 2732	10, 40
17TYS38-70A	25	B-41032-3	10	KIT 2732A	10, 40
17TYS38-53A1	25	B-41034-3	10	KIT 2744	11, 12, 41
18N-4-3221-1X	25	B-41036-3	10	KIT 2791	41
18N-4-3221X	24	B-41592-1	9	KIT 2791A	41
18N-4-3371	24	B-41650-1	10	KIT 2792	42
18N-4-3381-1X	25	B-41806-1	9, 10	KIT 2793	42
18N-4-3581-1X	25	H-715311	9	KIT 2885	42
18N-4-3581X	24	H-715334	9	KIT 2886	42
18NYS32-12A2	24	HM-813810	4	KIT 4435	43
18TYS32-12A2	25	HM-813844	4	KIT 4436	43
5WCS38-12A2	27	JHM-720210	11	KIT 4437	43
5WCS38-24A	27	JHM-720249	12	KIT 4438	44
82NYS32-74	26	JM-515610	3	KIT 4440	44
82NYS32-74A2	26	JM-515649	3	KIT 4441	45
82NYS38-28A	26	JM-822010	11	KIT 4442	45
92NYS38-52A	26	JM-822049	12	KIT 4443	46
92NYS38-52A2	26	KIT 1536	32	KIT 4444	46

NUMERICAL PARTS LISTING

PART NUMBER	PAGE
KIT 4445	1, 46
KIT 4446	1, 46
KIT 4450	47
KIT 4459	47
KIT 4460	47
KIT 4744	48
KIT RP180 1625	48
KIT RP180 1833	48
KIT RP35380	48
KIT RP35380A	49
KIT RP380	49
KIT RP380A	49
KIT RR26185-1752	50
KIT RR26185A-1752	50
KIT RR35380	50
KIT RR35380A	50
KIT RR380	50
KIT RR380A	51
KIT RS23180	51
KIT RS23180A	51
MPS 3355	51
MS-208020-1	11
MS-208045-1	5
MS-210016-1	15
MS-212045-1	9
MWA-506	11, 15
MWA-508	11
MWA-512	9
MWA-516	15
N-68-1	4
N-110-1	2, 18
NL-26-1	4
NL-210-1	6
P-16	6
P-28S	17
P-112	2
P-212	17
R945008	7
S-256A-2	1
S-256P-2	5
S-2510-2	6
S-2518-2	7
S-2610-2	5, 7
S-2616-2	5, 7
S-2626-2	4
S-2710-2	16

PART NUMBER	PAGE
S-2711-2	16
S-2812-2	4, 5, 7
S-2814-A2	5
S-11440-2	2
S-21016-2	2
SN-1020-1	17
SN-1036-1	17

NOTES

MAINTENANCE INFORMATION



Maintenance Manual No. 5E for carriers of forward tandem axles.

Maintenance Manual No. 5 for carriers of 180, 185 or 186 Series single axles and 180, 185 or 186 Series rear tandem axles.



Maintenance Manula No. 6C for carriers of 380 Series single axles and 380 Series rear tandem axles.

NOTES

NOTES

ARVINMERITOR AFTERMARKET PARTS WARRANTY

We warrant all new parts for one year from date of shipment to the buyer against defective material or workmanship (but not against damage caused by accident, abuse or improper installation, maintenance or repair) when such parts are used on vehicles the specifications of which have been approved by our Engineering Department.

As the exclusive remedy under this warranty, we will, at our option, repair or replace such parts free of charge, or take back the nonconforming parts and refund the monies paid by buyer for such parts, if found on examination by us to be nonconforming and if any necessary return charges are prepaid.

If it is necessary to return any parts under this warranty, buyer agrees not to make any deduction on account thereof from remittances on current accounts while claims are in the process of disposition. Any expense incurred without our consent for repairs or replacement will not be allowed.

THIS WARRANTY IS EXPRESSLY IN LIEU OF ALL OTHER WARRANTIES OR CONDITIONS, EXPRESS, IMPLIED OR STATUTORY, INCLUDING ANY IMPLIED WARRANTY OF MERCHANTABILITY OR FITNESS FOR PARTICULAR PURPOSE. IN NO EVENT SHALL SELLER BE LIABLE FOR INCIDENTAL OR CONSEQUENTIAL DAMAGES OF ANY NATURE.

Only genuine ArvinMeritor replacement parts are covered by this aftermarket parts warranty.

Distributed by:



ArvinMeritor[™]

Meritor Heavy Vehicle Systems, LLC
7975 Dixie Highway
Florence, Kentucky 41042 USA
888-725-9355

www.arvinmeritor.com
XpresswayPlus.arvinmeritor.com

Information contained in this publication was in effect at the time the publication was approved for printing and is subject to change without notice or liability. ArvinMeritor reserves the right to revise the information presented or discontinue the production of parts at any time.

Litho in USA
Revised 10/08
PB-9108 (13028/05060)
©2008 ArvinMeritor, Inc.



MERITOR

**Meritor Differential Model RT-58-185 - RP-24-180/185 - Carrier
A84-3200-M-1833**

Pro Gear parts manual for Meritor Differential Model RT-58-185 - RP-24-180/185 - Carrier A84-3200-M-1833 to assist in identifying the correct configuration of your Meritor 380 Series differential. This Meritor Tandem Front Axle is built with 46 or 50 Axle spline and ratios available in 3.73 thru 10.62.

If you need any assistance identifying the correct Meritor differential unit for your truck or equipment, contact your Meritor differential replacement specialists at Pro Gear and Transmission.

Pro Gear stocks every part for your Meritor differential. We have 1000's of products in shop that are ready to ship internationally for your next project.

For parts or service contact the Meritor specialists at Pro Gear & Transmission, Inc.

 CALL US

 EMAIL US

 VISIT MODEL PAGE

 VISIT ONLINE STORE